

SILVER CITY MINERALS LIMITED

ABN 68 130 933 309

ASX Code: SCI

Silver City Minerals

Copper and Zinc @Broken Hill

October 2017

Important Disclaimer

This presentation is provided to you for the sole purpose of providing background technical, financial and other information to enable you to review the business activities of Silver City Minerals Limited ("Silver City", "SCI" or the "Company"). This presentation contains forward looking statements concerning Silver City Minerals Limited. Forward-looking statements are not statements of historical fact and actual events and results may differ materially from those described in the forward looking statements as a result of a variety of risks, uncertainties and other factors. Forward-looking statements are inherently subject to business, economic, competitive, political and social uncertainties and contingencies. Many factors could cause the Company's actual results to differ materially from those expressed or implied in any forward-looking information provided by the Company, or on behalf of, the Company. Such factors include, among other things, risks relating to additional funding requirements, metal prices, exploration, development and operating risks, competition, production risks, regulatory restrictions, including environmental regulation and liability and potential title disputes. Forward looking statements in this document are based on Silver City's beliefs, opinions and estimates of Silver City Minerals as of the dates the forward looking statements are made, and no obligation is assumed to update forward looking statements if these beliefs, opinions and estimates should change or to reflect other future development. Nothing in this material should be construed as the solicitation of an offer to buy or sell SCI securities.

Competent Person

Information in this document that relates to Exploration Results, Mineral Resources or Ore Reserves is based on information compiled by Christopher Torrey, who is the Managing Director and full-time employee and shareholder of Silver City Minerals Limited, and a Member of the Australian Institute of Geoscientists. Mr Torrey has sufficient experience which is relevant to the style of mineralisation and type of deposit under consideration and to the activity which he is undertaking to qualify as a Competent Person as defined in the 2012 Edition of the "Australasian Code for Reporting of Exploration Results, Mineral Resources and Ore Reserves". Mr Torrey consents to the inclusion in the report of the matters based on his information in the form and context in which it appears.

Attractive Investment proposition

- Large tenement position at Broken Hill (≈ 1000 km²)
- Key projects: Copper-Cobalt and Zinc close to Broken Hill
- Broken Hill home to worlds largest Zinc-Lead-Silver Deposit. Has long mining heritage – birthplace of BHP Billiton and Rio Tinto
- Excellent infrastructure and JV partner with mill in Broken Hill
- Global zinc deficit and upswing in copper price
- Pipeline of news flow to come

Company snapshot



Top shareholders

Upsky Equity Pty	3.6%
SCI Directors	3.6%
Jennings Family Investments	3.3%
HSBC Custody Nominees	2.6%
Calm Holdings Pty Ltd	2.5%
Mr John Henry Toll	2.3%

Key metrics

Market cap (at 5.5 cents)	\$10.8m	Cash on hand (at 30 September 2017)	\$1.2m
52-week high	6.3¢	Top 20 shareholders	37.2%
52-week low	1.6¢	Shares on issue (No.)	196.2m
30-day average volume	2.96m	Unlisted Options	28.2m

ASX COPPER EXPLORERS – AUSTRALIAN PROJECT MARKET CAP \$M

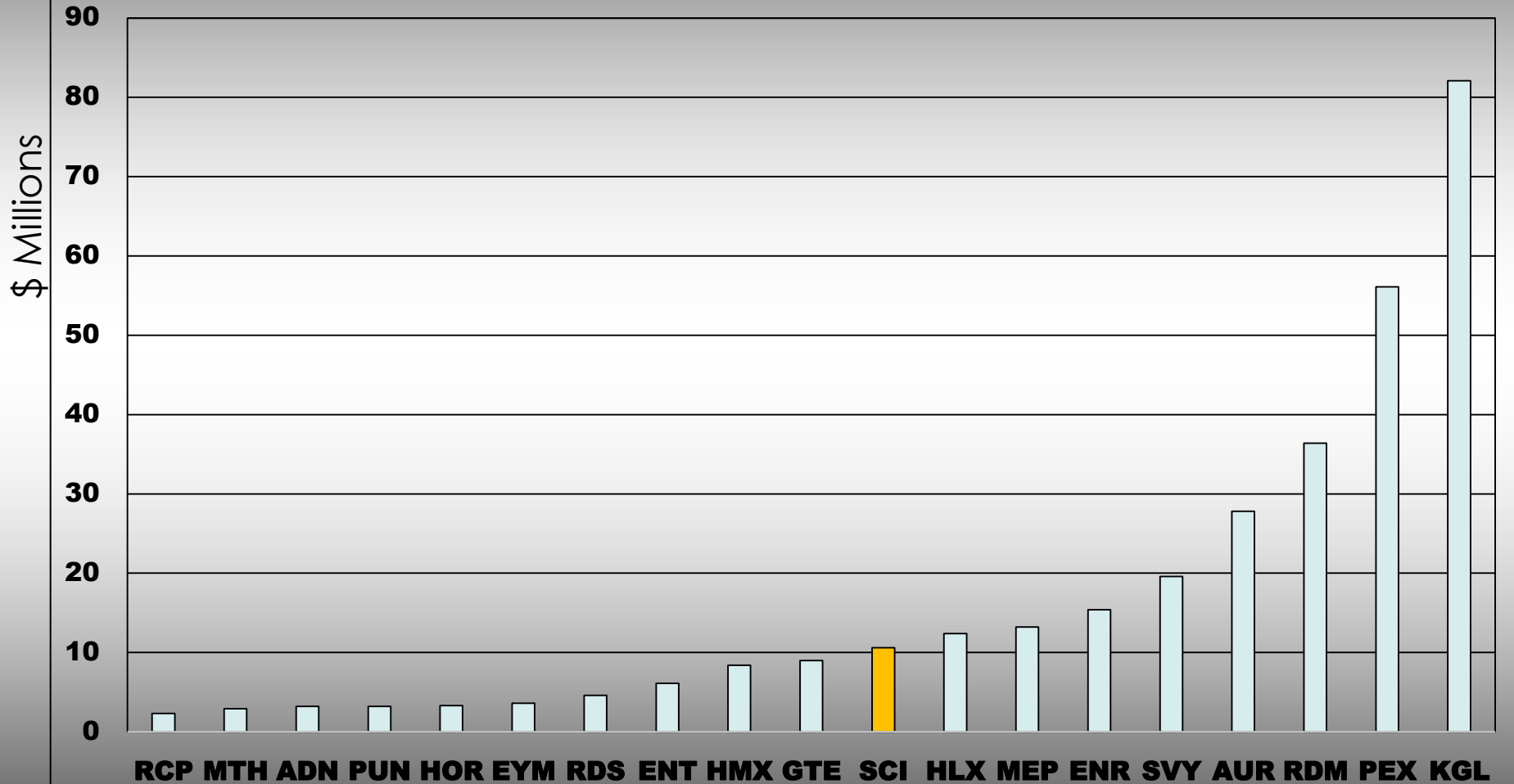

Board of Directors



Bob Besley
Chairman

Geologist with over 40 years experience in mining and exploration. Founder and original Managing Director of CBH Resources Limited. Bob took that company from inception as a junior explorer to a large zinc, lead and silver producer with a peak market cap of \$600m. Currently Chairman of Image Resources Limited.



Chris Torrey
Managing Director

Geologist with over 35 years experience in international mineral exploration. Senior management and consulting roles with Cyprus-Amax, ASX-listed Golden Cross Resources, US-listed Golden Minerals and Apex Silver. Past Chairman of Golden Cross Resources.



Ian Plimer
Non-Executive Director

Ian Plimer was the inaugural Professor of Mining Geology (University of Adelaide) and Emeritus Professor of Earth Sciences at The University of Melbourne. Ian is considered to be the world expert on the geology of the Broken Hill orebody on which he has worked and published extensively for almost 50 years.



Greg Jones
Non-Executive Director

Greg is a geologist with 35 years exploration and mine operational experience. Senior management roles with Western Mining and Sino Gold. He currently holds directorships with ASX-listed companies; Moly Mines, Eastern Iron Limited and Thomson Resources. Greg is the Executive Technical Director of Variscan Mines Limited.



Josh Puckridge
Non-Executive Director

Josh is a Corporate Finance Executive formerly working as a specialist Equity Capital Markets Advisor for Fleming Australia, a Corporate Advisory and Funds Management firm. He has significant experience within funds management, capital raising, mergers, acquisitions and divestments of projects by companies listed on the Australian Securities Exchange.

Silver City minerals projects

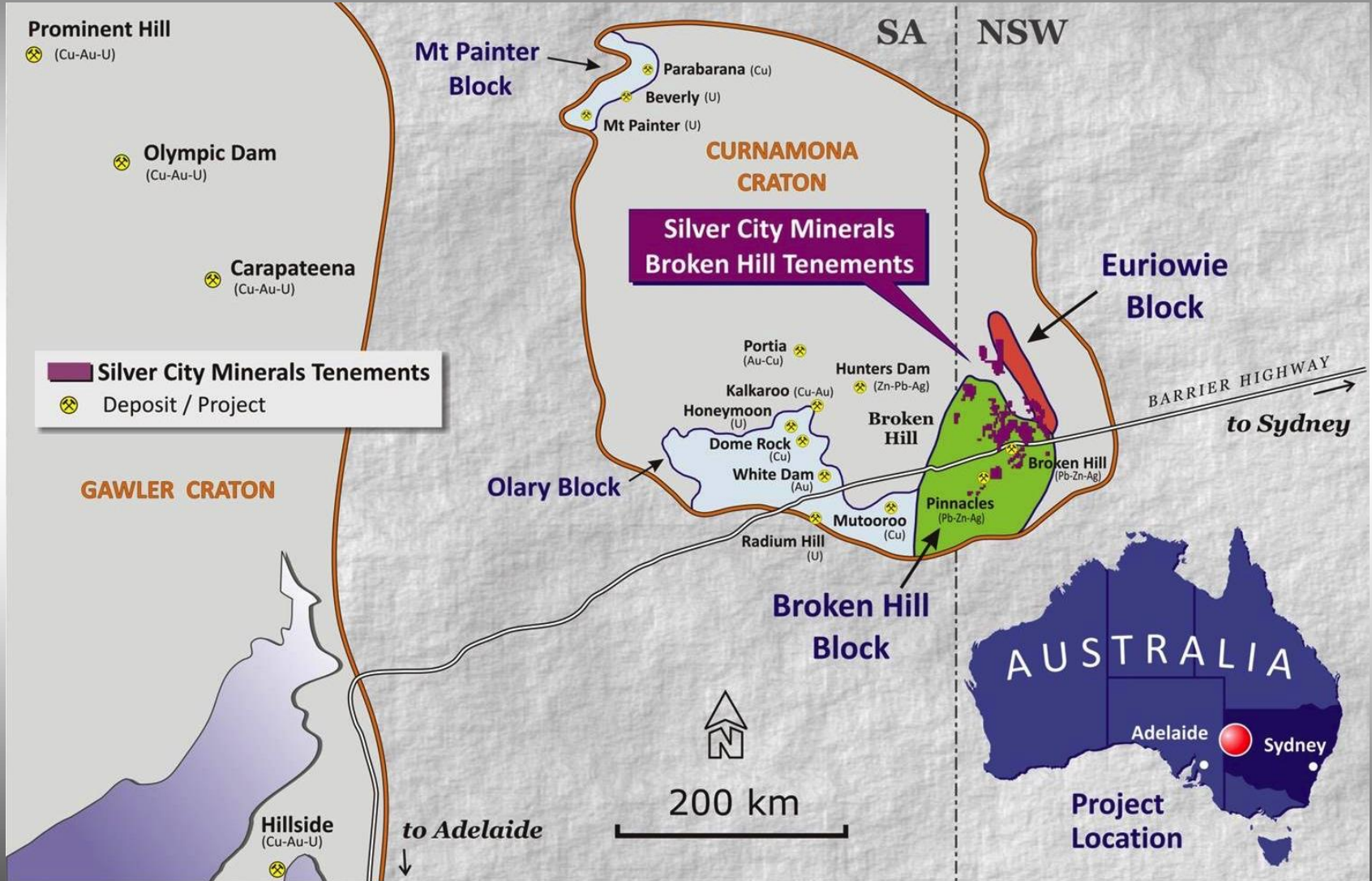

Broken Hill tenements

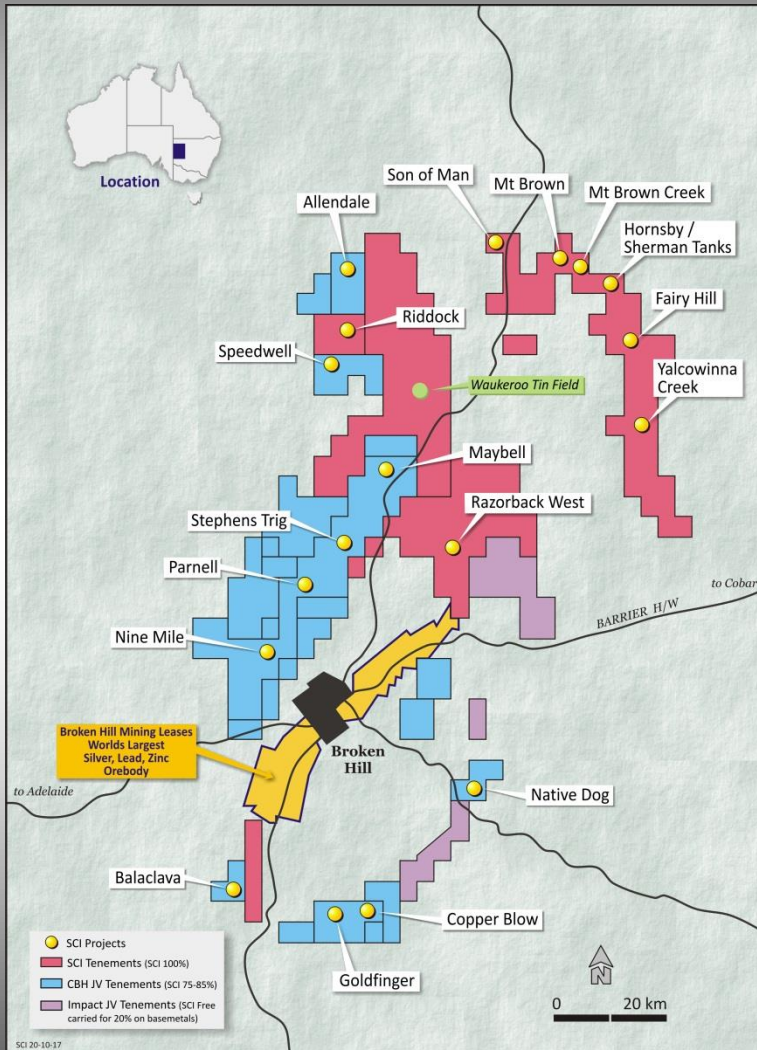

- Large tenement position
- Copper-Cobalt,
- Zinc-Lead-Silver
- Excellent infrastructure; mining centre
- Joint venture arrangements with CBH Resources and Impact Minerals

Project highlights

- Copper Blow and Razorback West
- Both significant geochemical anomalies under cover
- Both with mineralised drill intersections
- Both within 20km of a sulphide treatment plant
- Copper Blow in JV with CBH Resources (75/25, SCI/CBH)
- Razorback West 100% SCI

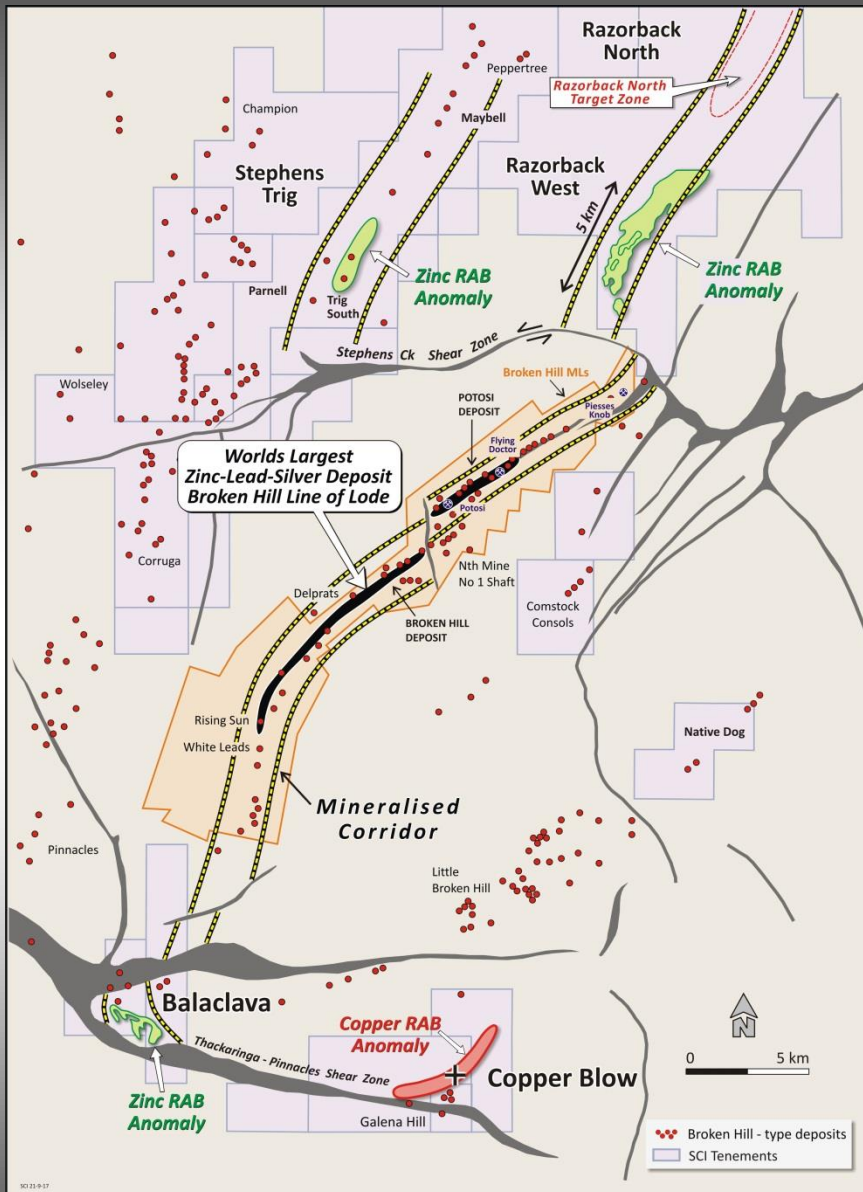

Copper Blow Key Features

- High grades in SCI holes
 - **4 metres at 6.1% copper, 4.23 g/t Au, 13 g/t Ag and 220 ppm cobalt from 188 metres (hole 17CB041) including:**
 - **1 metres at 11.3% copper, 10.7 g/t gold, 25 g/t silver and 405 ppm cobalt from 191 metres**
 - **8.2 metres at 1.9% copper and 0.53 g/t gold 131.8 metres (hole 17CB043)**
 - **2 metres at 2.4% copper, 0.8 g/t gold, 5 g/t silver and 95 ppm cobalt from 162 metres (hole 17CB041)**
- High grades in historic holes
 - **11.8 metres at 6.7% copper and 1.92 g/t gold**
 - **3 metres at 4.6 % copper**
 - **2.7 metres at 5.7% copper and 4.2 g/t gold**
- Trenches on surface host high grade copper; **3m at 8.9%, 3m at 8.4%, 3m at 5.8%, 4m at 5.7%, 6m at 2.5%**

Results in ASX Releases 4th May 2017, 19 June 2017 and 26 and 27 Sept 2017, 5th October 2107

Copper Blow exploration

- Immediate drill targets at Copper Blow; first phase drilling completed 11 holes
- Copper, gold, silver, cobalt, molybdenum, rare earth potential
- 6 kilometres of strike potential

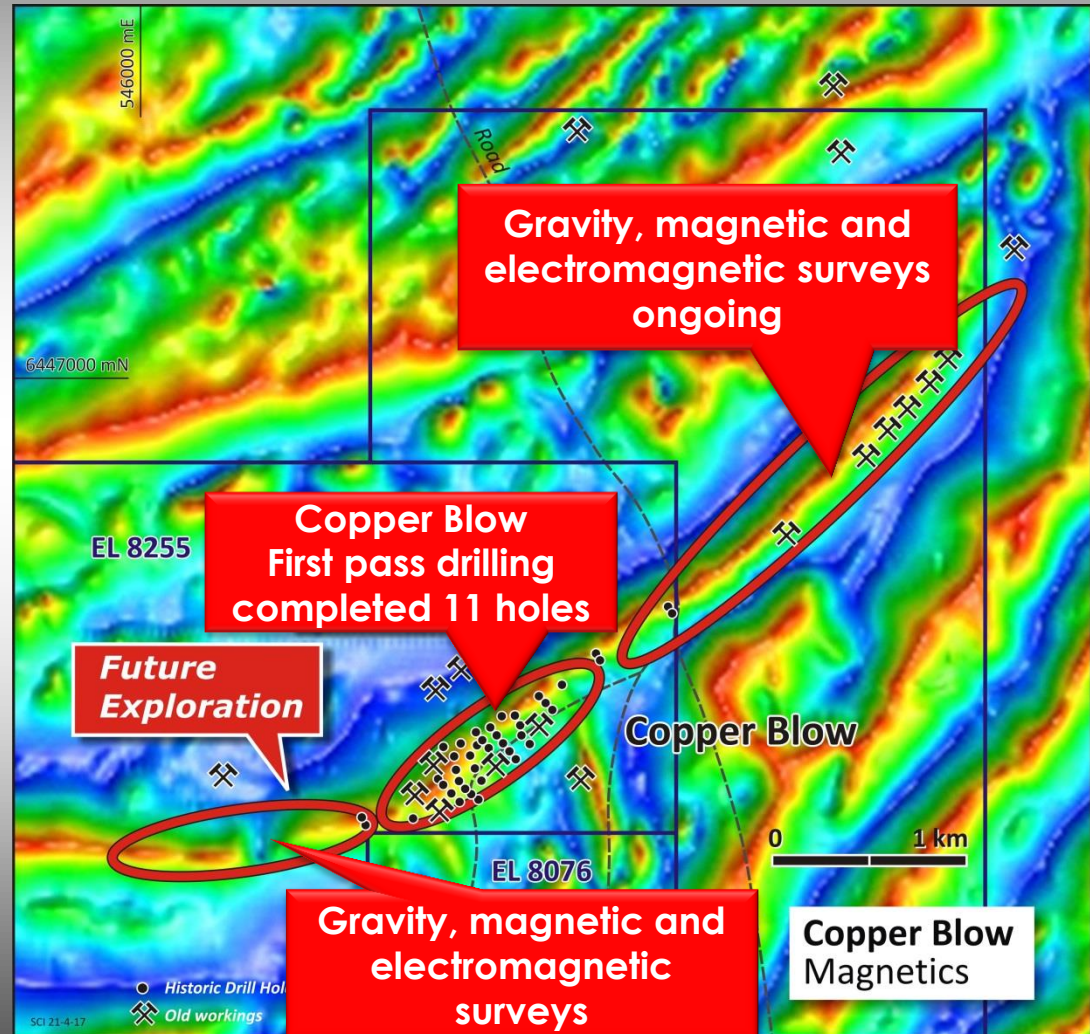

Copper Blow upside

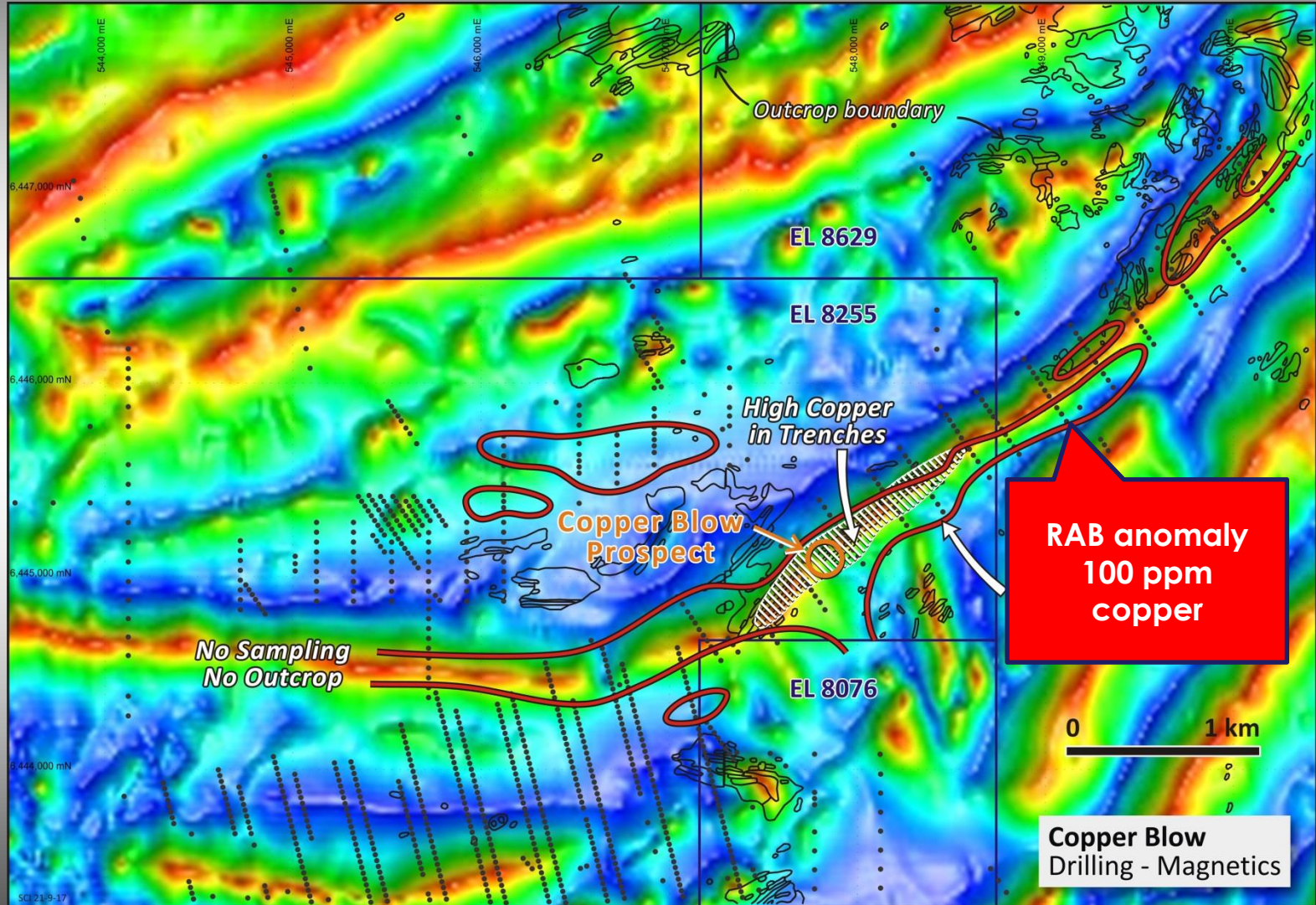

Mineralisation Styles



Drill core samples within intersections of +5% copper

Copper Blow Drilling

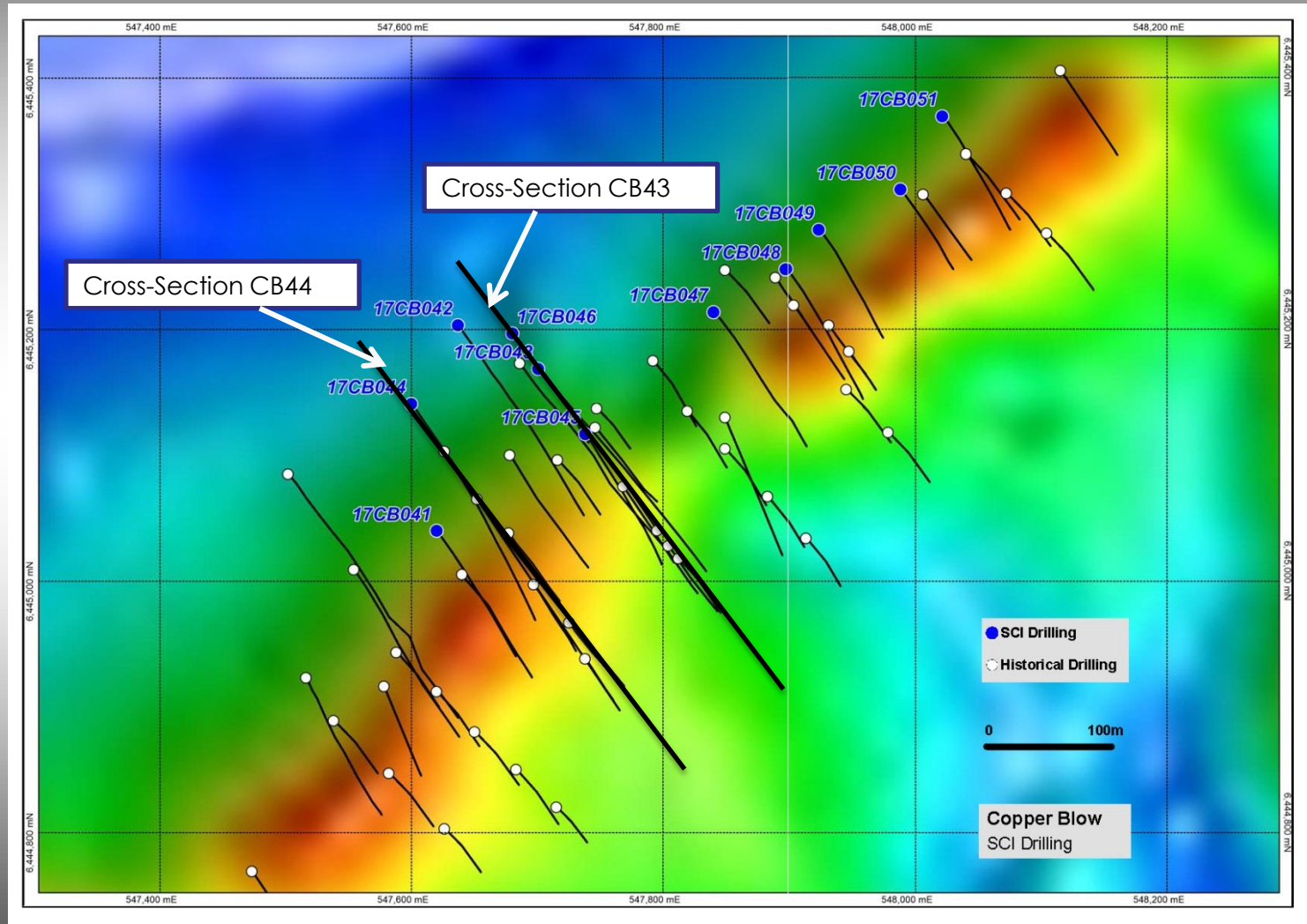

Copper Blow Drilling

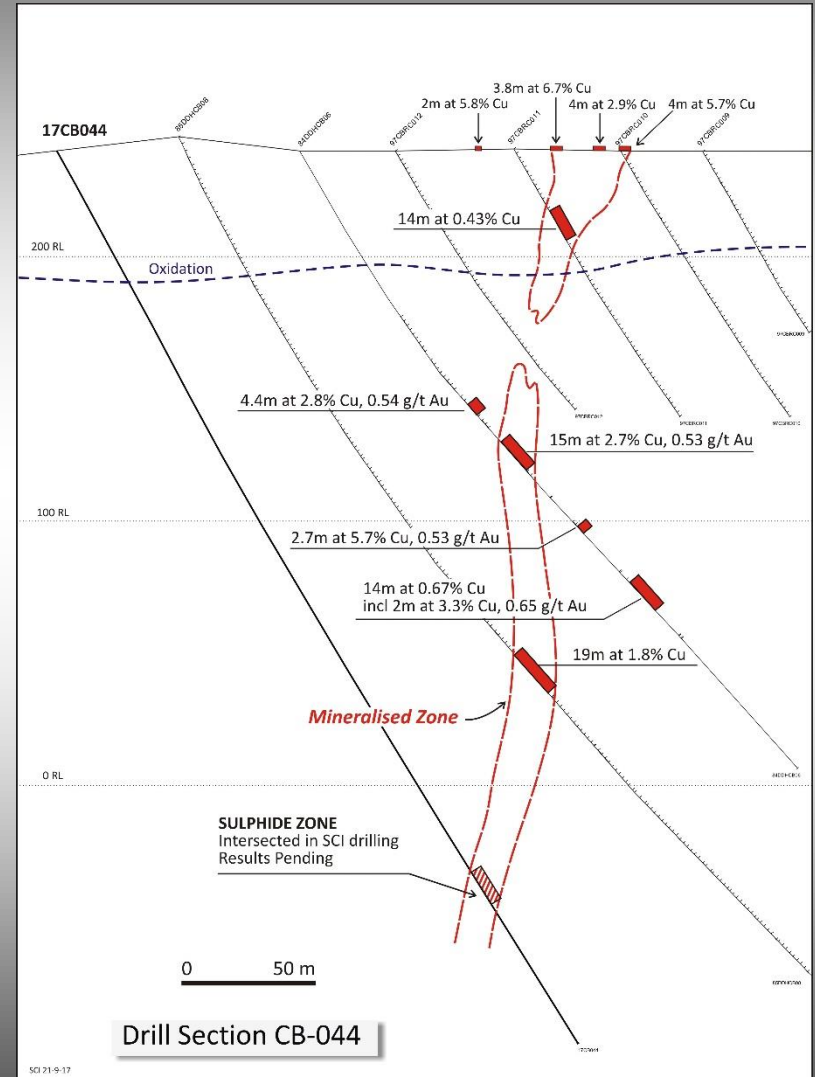
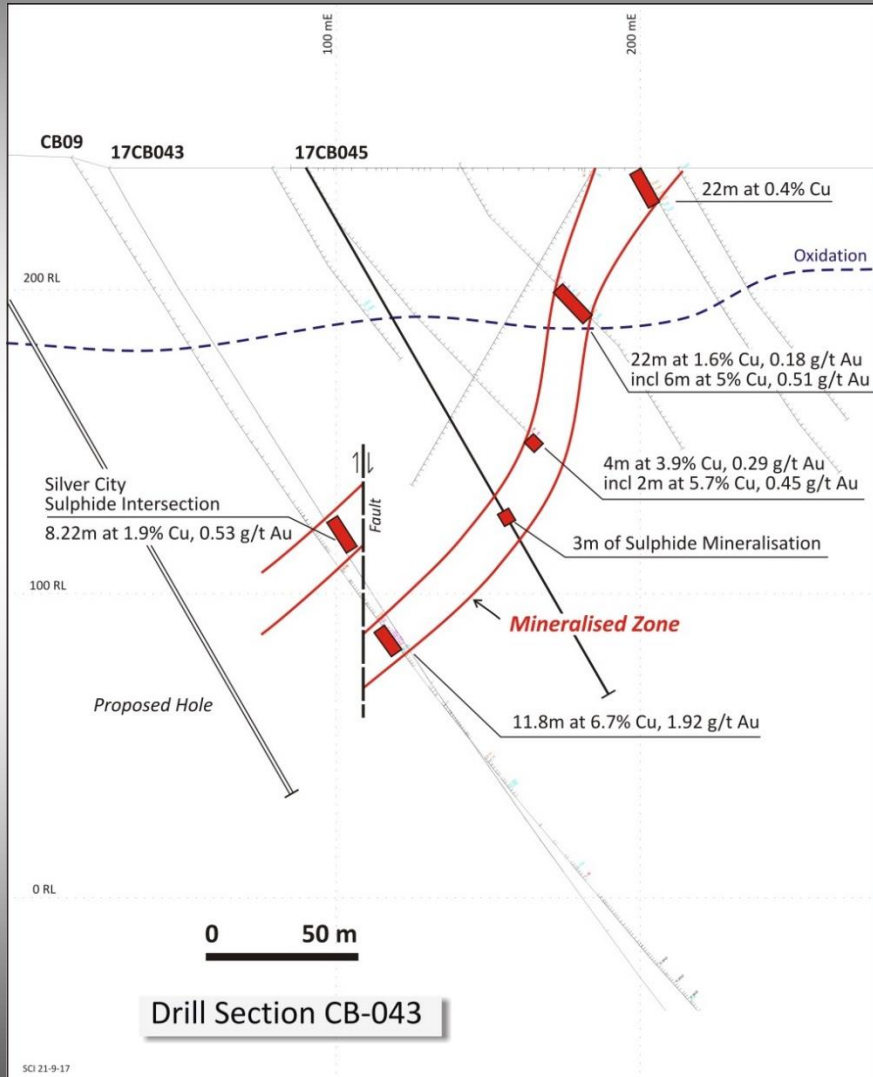

Razorback West Gravity

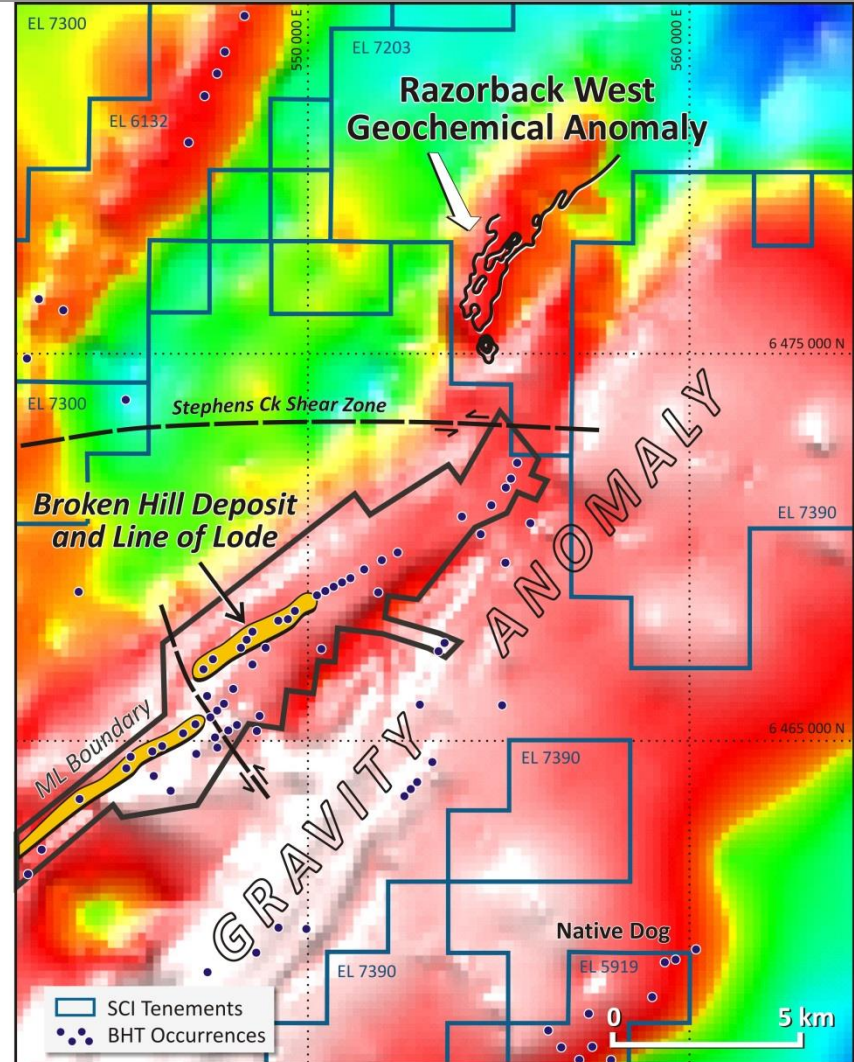
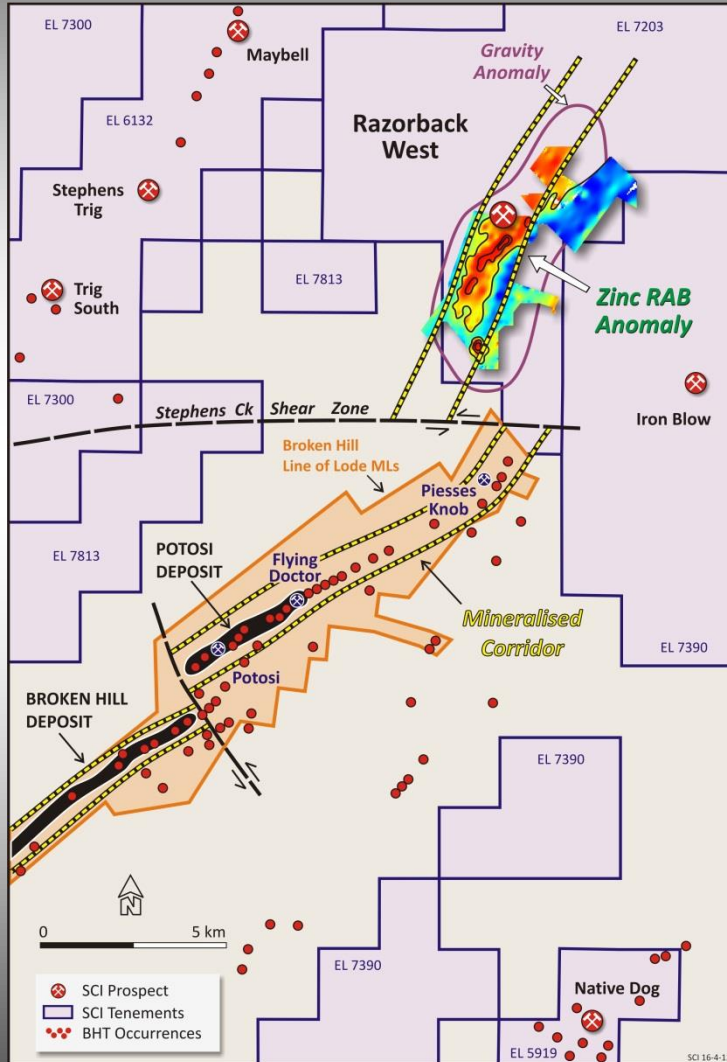

Razorback West Key Features

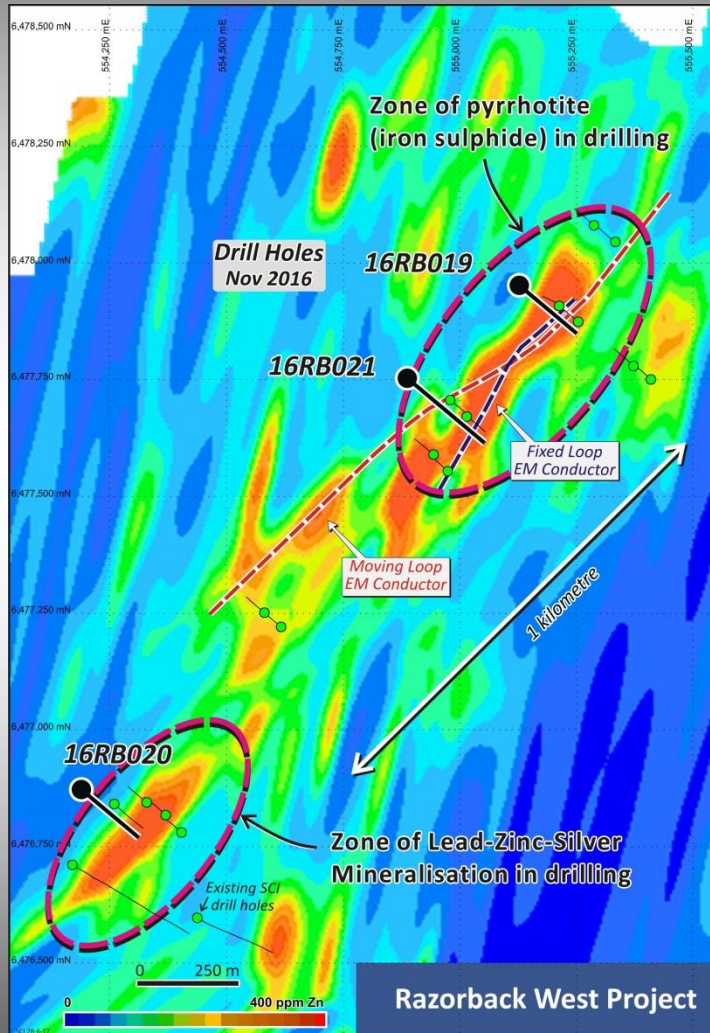

- Extensive RAB geochemical anomaly beneath cover (plus 5km strike)
- Rock sequence same as Broken Hill mine corridor offset by a fault
- Coincident geophysical anomalies
- Broad zones of elevated zinc
 - **93 metres at 0.14% Zn**
- Detailed gravity survey planned

Results in SCI Quarterly Report Dec 2016, ASX Release 12 July 2012

New projects

- Yalcowinna EL
- Copper and Copper-Cobalt belt over 25km
- 8 prospects
- High grade rock chip samples eg Yalcowinna Creek
 - Copper: 11.9%, 6.9%, 4.6%, 3.7%
 - Cobalt: 1650 ppm, 1500 ppm, 1200 ppm
- Best results 37.7% Copper and 0.23% Cobalt

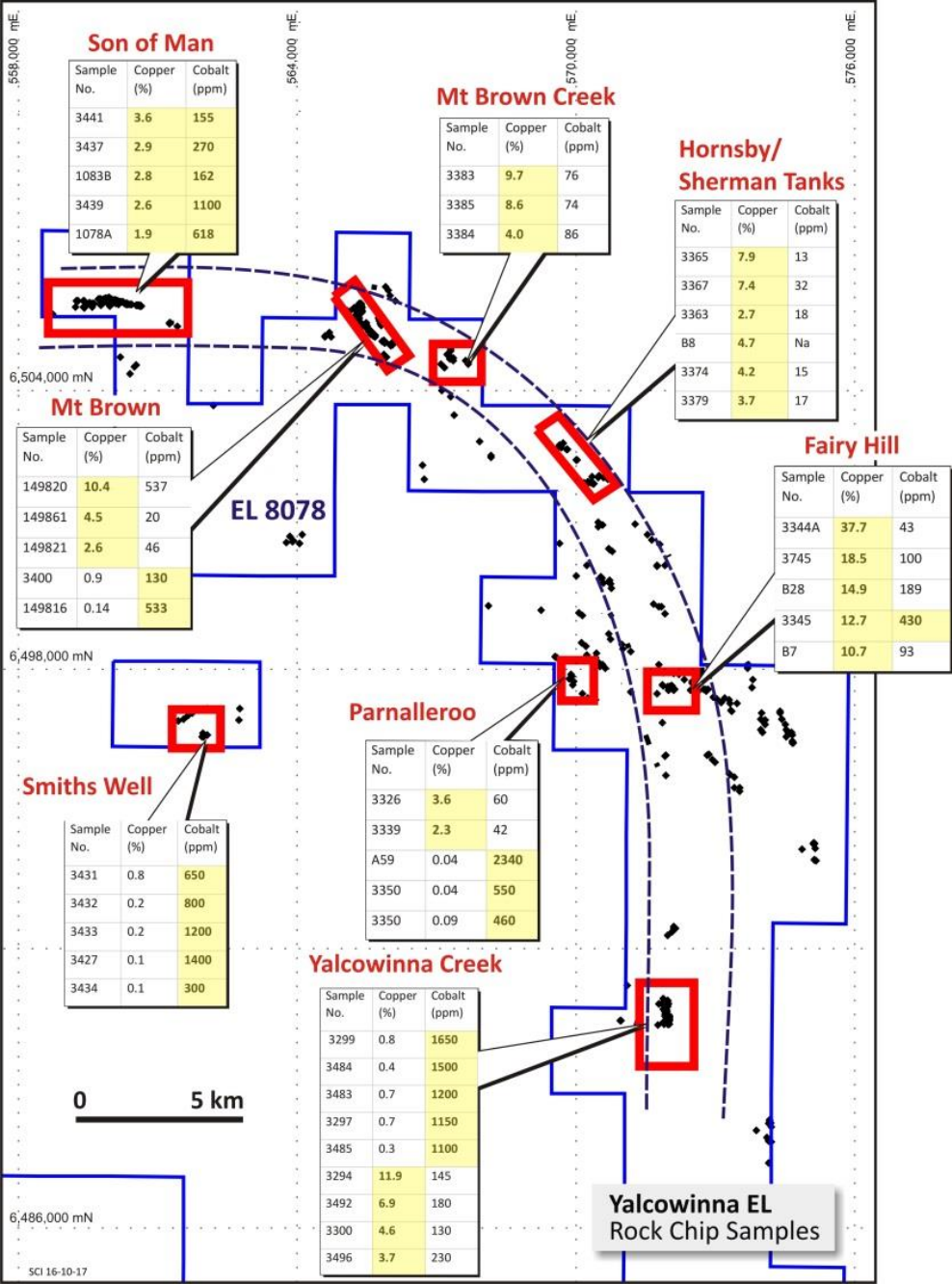

Global Zinc demand supply forecast (Mt)

Mt of Zinc

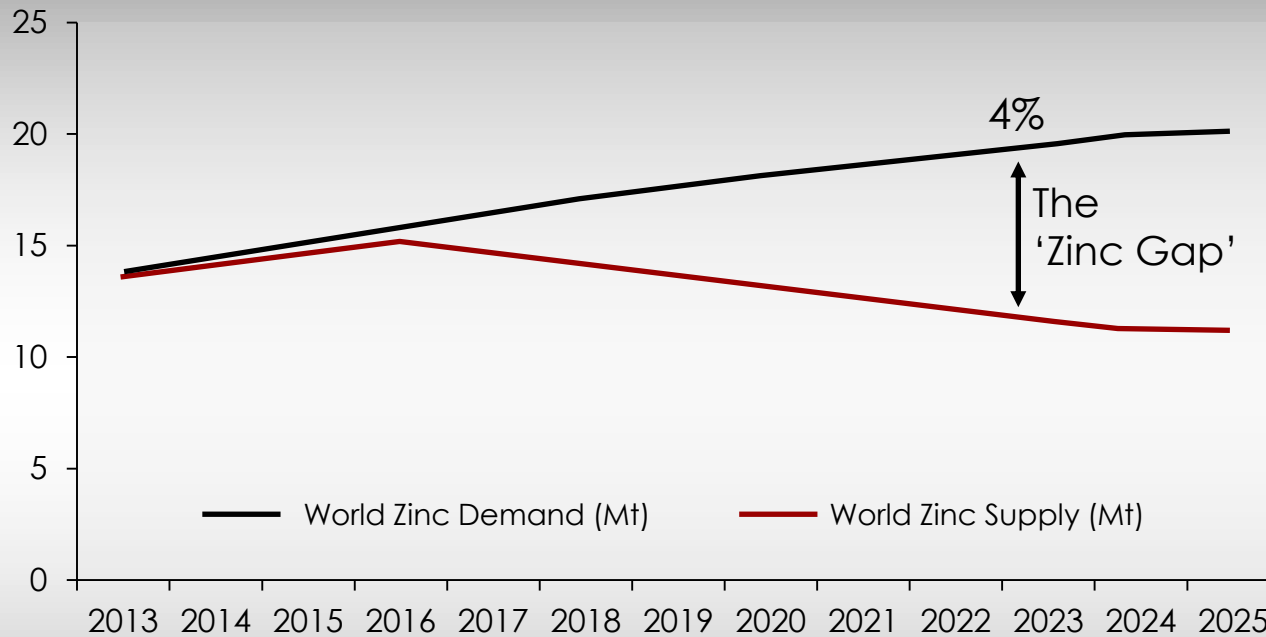

Source: HDR | Salva

Increasing demand-supply gap forecast for Zinc

- Demand increasing
- Mines closing
- Limited new mine capacity to fill the gap

A new zinc discovery of typical high grade Broken Hill ore (+15% Zn+Pb) will fill a significant part of the shortfall

Next steps

Work Program

Item	Comment
Copper Blow	<ul style="list-style-type: none">• Geophysics: Ground gravity, magnetics and electro magnetics(EM), downhole EM• RAB drilling• Follow-up RC and diamond drilling
Razorback West	<ul style="list-style-type: none">• Geophysics: Detailed ground gravity survey• Follow-up RC and diamond drilling
Yalcowinna	<ul style="list-style-type: none">• Prospect sampling and ranking• Ground EM surveys• First pass RC drilling

Milestones next 12-months

Copper Blow

- drill results (11 holes)
- Downhole EM results
- Ground geophysical surveys

Razorback West

- Ground geophysical surveys to assist drill target definition

Yalcowinna

- Field geology and sampling. Project ranking

- Follow-up RAB and RC drilling of geophysical targets

- RAB and RC drilling of geophysical targets

- Ground EM surveys
- RAB drilling

- Follow up drilling of RAB anomalies
- Detailed resource drilling

- Detailed resource drilling

- First pass RC drilling

Oct-Nov

Dec-March

April-Sept

Summary

- Company-making opportunity in both Zinc and Copper-Cobalt
- Two existing sulphide treatment plants within 20km
- Supportive JV partner
- Broken Hill Mining Centre: ready access to infrastructure and workforce
- SCI attractively priced with low market cap
- Multiple activities and milestones in next 12-months

SILVER CITY MINERALS LIMITED

ABN 68 130 933 309



ASX Code: SCI

Level 1, 80 Chandos Street
St Leonards
NSW 2065
Australia
+61 2 94371737

www.silvercityminerals.com.au