

Alpha HPA

ABN 79 106 879 690

The Manager Companies - ASX Limited  
20 Bridge Street  
Sydney NSW 2000

ASX: **A4N**  
ASX Announcement  
17 March 2020

(28 pages by email)

## HPA FIRST PROJECT DFS

### HIGH MARGIN, LARGE VOLUME HPA PRODUCTION CONFIRMED

#### HPA FIRST PROJECT SET TO DELIVER HPA FOR THE LOW CARBON EV AND LED INDUSTRIES

- **Definitive Feasibility Study delivered for the HPA First Project**
- **Comprehensive technical and financial validation of the Company's HPA First Project**
- **Compelling cashflow - A\$280M\* pa at 10,000tpa HPA**
- **Proven process capable of delivering >99.99% HPA purity**
- **Immediate focus to project financing and completion of permitting and offtakes**
- **Marketing confirms strong HPA pricing in a supply constrained 4N HPA Market**

The Board of Alpha HPA Limited ('Alpha HPA' or 'the Company') is pleased to announce the results of the HPA First Definitive Feasibility Study (DFS), based on the construction and operation of the Project within the Gladstone State Development Area (GDSA), QLD. The DFS is the result of an intensive 12-month program of project piloting and detailed engineering. The DFS has confirmed the HPA First Project as both technically robust and financially compelling.

The Alpha HPA Board has now committed to a full project financing process, in parallel with completion of project permitting in the expectation of a successful market outreach program and securing HPA offtake agreements.

#### DFS Highlights:

- **Production rate of 10,000tpa HPA**
- **Annual free cashflow increased to A\$280M\*\***
- **Unit cash costs of A\$8,730 (US\$5,940)/t HPA after by-product credits**
- **Project CapEx of A\$308M (US\$209M)**
- **Capital intensity of A\$30,800 (US\$20,900)/tpa HPA**
- **Financially robust project with high profitability at HPA prices as low as US\$10,000/t**

\*HPA price of US\$25/kg and USD/AUD = 0.68

\*\*Relative to March 2019 PFS = A\$265M

Managing Director, Rimantas Kairaitis, commented "The HPA First Project DFS is the result of a rigorous technical and financial process validating the Project as a compelling business case. The DFS outcomes, combined with the recent memorandum of understanding with Orica and finalisation of the project site in Gladstone QLD, have now laid a firm foundation for the next steps permitting, financing and construction of the Project."

## HPA FIRST PROJECT - DFS SUMMARY

### Technical

The DFS has validated the HPA process flow sheet through the construction and operation of the HPA First Pilot Plant facility in Brisbane, QLD. The Pilot Plant recorded over 600 hours of operating time and generated over 40kg of high purity alpha-phase alumina of >99.99% purity for end-user qualification and vendor testwork. The Pilot Plant was the first time the flowsheet has been operated on a fully integrated basis. Pilot Plant operation finalised the detailed mass and energy balance allowing for calculation of the material flowrates through equipment, reagent use, impurity department, by-product quantities and utilities demand. Equipment selection was based on detailed engineering design, and selection of construction materials based on detailed materials testwork.

The DFS process and outcomes has also been subject to technical review by Orica Australia Pty Ltd (Orica), as chemical counterparty to the project under the Alpha-Orica memorandum of understanding (MOU) (ASX announcement:10 February 2020).

### Financial

Consistent with outcomes of the Pre-Feasibility Study (PFS): (ASX announcement 7 March 2019) the HPA First Project presents a compelling financial business case, generating an estimated A\$280M\* pa in operating cashflows at full production. Headline financial metrics of the DFS are presented in the tables below:

HPA First Project		
Key Project Parameters	A\$	US\$
A\$/US\$ Exchange Rate	0.68	
HPA Production (t/y)	10,000	
Annual Average Cash Operating Cost	\$127million	\$86million
Unit Cash Cost (\$/t HPA)	\$12,750	\$8,670
Unit Cash Cost accounting for by-products (\$/t HPA)**	\$8,730	\$5,940
Aluminium Feedstock Processed (t/y)	18,592	
Pre-Production Capital Cost	\$308 million	\$209 million
Capital Intensity (CapEx\$/ per tpa HPA)	\$30,800	\$20,900

Key Project Parameters	HPA Pricing Scenarios					
	USD \$25/kg		USD \$20/kg		USD \$15/kg	
	AUD	USD	AUD	USD	AUD	USD
Annual Revenue @ 10,000tpa	\$368 million	\$250 million	\$294 million	\$200 million	\$221 million	\$150 million
Annual Pre-Tax Cashflow	\$280 million	\$191 million	\$207 million	\$141 million	\$133 million	\$91 million
Payback	< 2 years		<3 years		<4 years	

\*\*HPA Price of US\$25/kg and USD/AUD = 0.68

Alpha HPA engaged independent market research firm, the CRU group, to conduct a detailed analysis of the global HPA market, including a breakdown of the existing market supply, demand and cost structure, as well as a detailed forward projection of HPA supply demand and pricing. Based on this detailed analysis, CRU advise a realistic pricing of US\$25/kg for 4N HPA represents current pricing of 4N HPA, with forecast pricing of US\$25/kg over the first 5 years of the Project life (refer Section 11). In addition to the CRU analysis, the Company has also commenced an international market outreach program with a view to securing direct offtake relationships with end-users. Based on both CRU and the Company's own market outreach, and to accommodate scenarios of potential price discounting to penetrate supply chains, revenue metrics are presented below across a range of HPA price points in the Table below.

As the HPA First Project is not constrained by mine life, there is no fixed project life, and therefore a discounted cash flow (DCF) analysis was not performed. Rather, the financial analysis is presented on an EBITDA basis. Subject to the assumptions made, Alpha HPA expects the projected earnings to be maintained over the long term providing an extremely attractive investment proposition.

## Next Steps

With the successful delivery of a technically robust and financially compelling DFS for the HPA First Project, in combination with the recent MOU with Orica and securing of the Project site within the Gladstone State Development Area in Queensland, the Alpha HPA Board has committed to progressing the project through to a Final Investment Decision (FID) with the following steps.

- **Project Permitting and Approvals:** AECOM Consultants have been engaged to complete the project approvals on the HPA First Project.
- **Project Financing:** Alpha HPA will shortly engage project financing consultants to assist the Company compile financing proposals for the Project. This process will include assessment of the following funding sources:
  - Strategic funding connected to offtake counterparties
  - Government concessional lending, to include engagement with the Northern Australia Infrastructure Facility (NAIF) and the Clean Energy Finance Corporation (CEFC)
  - Export credit finance – domestic and international
  - Bank finance
- **Post DFS Engineering:** Commence detailed post-DFS engineering in preparation for EPCM tender packages
- **Extend Market Outreach:** Extend existing market outreach program to end-users in both the lithium-ion battery (LIB) supply chain and light emitting diode (LED) lighting sector with a view to securing offtake contracts to support project financing

## Opportunities

The Company is delighted with the DFS completion and current findings. In addition, some further significant technical and commercial opportunities for the project will be investigated in the coming months:

- The CapEx estimate includes \$25.3M (\$30.0M including Indirects) associated with the by-product concentration area (marked in a red box in Figure 9). The location and capital expenditure for this area remains subject to final engineering and evaluation with Orica, which may result in a CapEx adjustment and an attendant time-dated OpEx amortisation adjustment.
- The HPA Pilot Plant has recently successfully produced an alternative ceramic coating product, being high purity (4N) boehmite (Al-O-OH). The Company is in active discussions with end-users in the lithium-ion battery (LIB) supply chain regarding boehmite and will be shortly sending boehmite samples to these end-users for qualification testing. The addition of boehmite to the HPA First process provides excellent flexibility to produce alternative products based on end-user demand.

# HPA FIRST DEFINITIVE FEASIBILITY STUDY (DFS)

## 1. OVERVIEW

The HPA First Definitive Feasibility Study (DFS) was completed by Prudentia Process Consulting Pty Ltd (Prudentia PC) of Brisbane, Australia, with inputs from Alpha HPA and the proprietary solvent extraction (SX) and refining technology licensor, HPAlumina Pty Ltd.

The financial analysis and overall economics of the HPA First Project have been completed with an overall accuracy of -10% to +15%.

The capacity of the project is 10,000 dry tonnes per annum (dtpa) of HPA produced by the Project from an industrial aluminium chemical feedstock.

In addition to the primary HPA product, the HPA First Project produces a process by-product for sale.

The DFS process and methodology is summarised in Section 2 below.

## 2. DFS PROCESS AND METHODOLOGY

The DFS has been conducted as a fully integrated study, led by Prudentia PC with the following workflows and responsibilities.

Process	Description	Responsibility
<b>Pilot Plant</b>	Design, construction and operation of the full end-to-end process Flow Sheet from feedstock through to final HPA Product. Operated as 3 campaign with over 600 operating hours	Prudentia PC HPAlumina Pty Ltd Alpha HPA
<b>Engineering</b>	<ul style="list-style-type: none"> <li>• Equipment Sizing Basis using Mass Balance</li> <li>• Piping and instrumentation diagrams (P&amp;IDs)</li> <li>• Layout drawings</li> <li>• 3D model</li> <li>• Equipment register/enquiries/quote evaluation</li> <li>• Material take-offs (MTOs)</li> <li>• Electrical load list / single line diagrams (SLDs)</li> </ul>	Prudentia PC HPAlumina Pty Ltd
<b>Cost Estimation</b>	Operating Cost (OpEx) and Capital Cost (CapEx) estimation	Prudentia PC
<b>Permitting and Approvals</b>	Assessment of the key Government and Regulatory Approval steps through to Project Approval	AECOM Alpha HPA
<b>Marketing</b>	Detailed assessment of HPA market, supply-demand dynamics, interaction with HPA end-users and price discovery	CRU Alpha HPA

Figure 1: DFS Workflow and Responsibilities



### 3. CAPITAL EXPENDITURE (CAPEX)

#### 3.1 Estimation Process

Project Capital Expenditure (CapEx) was estimated by Prudentia PC based on the following key assumptions and process:

- The estimate is presented in Australian Dollars;
- The estimate is built up on the assumption of an engineering procurement and construction management (EPCM) execution;
- major mechanical equipment costing is based on the current equipment list with budget quotes sourced for major equipment;
- bulk materials estimate is based on detailed material take-off's (MTO's) with costs built up from first principles and checked with quotes from contractors to ensure alignment with current market pricing;
- construction labour has been based on market pricing and checked against contractor supplied information, contractor rates including profit, overheads and direct labour costs;
- labour is assumed to be sourced in the Gladstone region;
- Indirect Costs, including engineering, procurement and construction management (EPCM), spares, first fills and temporary construction facilities, have been included based on estimates aligned with the execution schedule and strategy;
- contingency has been included as a factor of the direct and indirect costs;
- all costs are exclusive of goods and services taxes, value added taxes, import duties and other taxes;
- process design flows have been updated during the study as results from the Pilot Plant were incorporated into the mass balance.

#### 3.2 CapEx Estimate

The HPA First Project CapEx estimate is set out in expanded form in Table 1 by area, and in summary form in Table 2.

Description	Net Estimate AUD	Growth and Wastage Allowance AUD	Total Cost AUD	Total Cost USD
<b>Directs</b>				
Earthworks	5,984,000	432,000	6,416,000	4,363,000
Civil	3,099,000	224,000	3,323,000	2,260,000
Concrete	13,908,000	1,003,000	14,911,000	10,140,000
Steelwork	16,313,000	1,176,000	17,489,000	11,893,000
Buildings & Architecture	4,934,000	356,000	5,289,000	3,597,000
Safety Equipment	2,441,000	191,000	2,632,000	1,790,000
Permanent Mobile Equipment	277,000	20,000	297,000	202,000
First Fills	7,355,000	221,000	7,576,000	5,151,000
Mechanical Bunks	28,612,000	2,063,000	30,676,000	20,859,000
Mechanical Equipment	85,830,000	6,189,000	92,019,000	62,573,000
Piping	23,341,000	1,683,000	25,024,000	17,017,000
Automation Computer Systems	914,000	66,000	980,000	667,000
Electrical Equipment	8,847,000	638,000	9,485,000	6,450,000
Raceway	2,618,000	189,000	2,806,000	1,908,000
Wire and Cable	9,852,000	710,000	10,563,000	7,183,000
Instrumentation and Control	5,320,000	384,000	5,704,000	3,879,000
<b>Total Directs</b>	<b>219,647,000</b>	<b>15,544,000</b>	<b>235,191,000</b>	<b>159,930,000</b>
<b>Indirects</b>				
Indirects (incl. EPCM)	44,423,000	1,610,000	46,034,000	31,303,000
Contingency (10.2% of Directs + Indirects)	26,907,000	-	26,907,000	18,297,000
<b>Total Indirects</b>	<b>71,330,000</b>	<b>1,610,000</b>	<b>72,941,000</b>	<b>49,600,000</b>
<b>Total</b>	<b>290,978,000</b>	<b>17,154,000</b>	<b>308,132,000</b>	<b>209,530,000</b>

Table 1: Expanded CapEx estimate by Totals (rounded to nearest \$1,000)

HPA First Project	
Area	AUD (million)
Processing Plant	\$173.10
Utilities	\$18.70
Infrastructure	\$39.20
Indirects	\$43.70
Owners Costs	\$6.50
Contingency	\$26.90
<b>TOTAL</b>	<b>\$308.10</b>

*Table 2: Summary CapEx estimate*

The CapEx estimate includes \$25.3M (\$30.0M including Indirects) associated with the by-product concentration area (marked in a red box in Figure 7). The location and capital expenditure for this area remains subject to final engineering and evaluation with Orica, which may result in a CapEx adjustment and an attendant time-dated OpEx amortisation adjustment.

## 4. OPERATING EXPENDITURE (OPEX)

### 4.1 Estimation Process

The operating cost estimate for the HPA First project was developed by Prudentia using the following key information;

- reagent consumption from the mass balance;
- reagent costs from suppliers or provided by Alpha HPA and Orica;
- labour costs from industry sourced data; and
- labour head count estimated based on the agreed organisation structure.

The estimate includes all costs associated with the nameplate production of high purity alumina including:

- feed & transport;
- residue disposal;
- labour;
- reagents and consumables;
- utilities;
- maintenance;
- contract services; and
- general and administration.

The operating cost estimate has been developed in accordance with the industry standards for a DFS. The ramp-up of the process plant to reach nameplate production has been estimated by Prudentia with assistance from the technology provider and Alpha HPA. The ramp-up takes into consideration that the unit operations are industry accepted standard practice and the plant is relatively small scale.

The ramp-up period has been set at 2 years with 52% of nameplate in year 1 and 92% in year 2.

Operating costs have been divided into fixed and variable costs as summarised below.

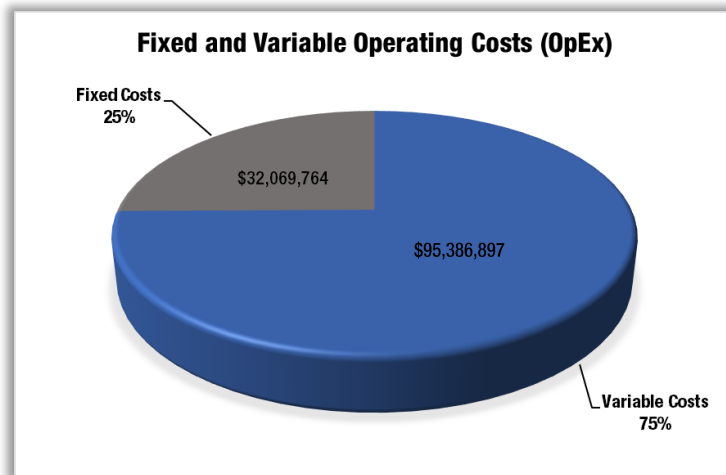

Figure 3: HPA First Project OPEX – Fixed vs Variable Costs

Description	Amount (AUD)	Amount (USD)
<b>VARIABLE COSTS</b>	<b>95,387,000</b>	<b>64,863,000</b>
Feed & Transport	7,908,000	5,377,000
Reagents	65,551,000	44,575,000
Utilities	18,036,000	12,264,000
Consumables	1,810,000	1,231,000
Product Transport	(incl in HPA sale price)	
Waste Disposal	2,082,000	1,416,000
<b>FIXED COSTS</b>	<b>32,070,000</b>	<b>21,807,000</b>
Labour	19,016,000	12,931,000
General Expenses	4,728,000	3,215,000
Maintenance	6,838,000	4,650,000
Contract Services	1,488,000	1,012,000
<b>TOTAL FIXED + VARIABLE COSTS</b>	<b>127,457,000</b>	<b>86,671,000</b>
By product Credits	40,114,000	27,278,000
<b>Total after By-Product Credits</b>	<b>87,343,000</b>	<b>59,393,000</b>
<b>Unit Production After By-Product Credits</b>		
OpEx per tonne of HPA (AUD)	8,730	
OpEX per per tonne of HPA (USD)	5,940	
<b>Unit Production Before By-Product Credits</b>		
OpEx per tonne of HPA (AUD)	12,750	
OpEX per per tonne of HPA (USD)	8,670	

Table 3: OpEx estimate, including unit production costs (rounded to nearest \$1,000)



## 5. REAGENT SUPPLY AND BY-PRODUCT OFFTAKE – ORICA AUSTRALIA

The HPA First Project requires the supply of two key chemical reagents, which are recycled inside the HPA production process as a by-product for sale back to the reagent supplier. The volume and nature of the reagents and by-product require the HPA First Project to be ideally located within 2 kilometres of a chemical counterparty, to allow for the reagents and by-product to be delivered by pipeline in liquid form.

In February 2020, Alpha HPA executed a MOU with Orica Australia (Orica) which sets out a pricing mechanism for both the key reagents as well as the by-product over an indicative 20-year term. The pricing mechanism compares favourably with the reagent and by-product pricing assumptions used in the updated PFS (ASX announcement: 7 March 2019). The MOU also sets out indicative quality specifications for the supply and delivery of the reagents and by-product. The terms of the MOU have been negotiated on the basis of pipeline supply and delivery from/to a Project site within the Gladstone State Development Area (See Section 6).

The reagent and by-product volumes in consideration (expressed at 100% concentrations) are set out below:

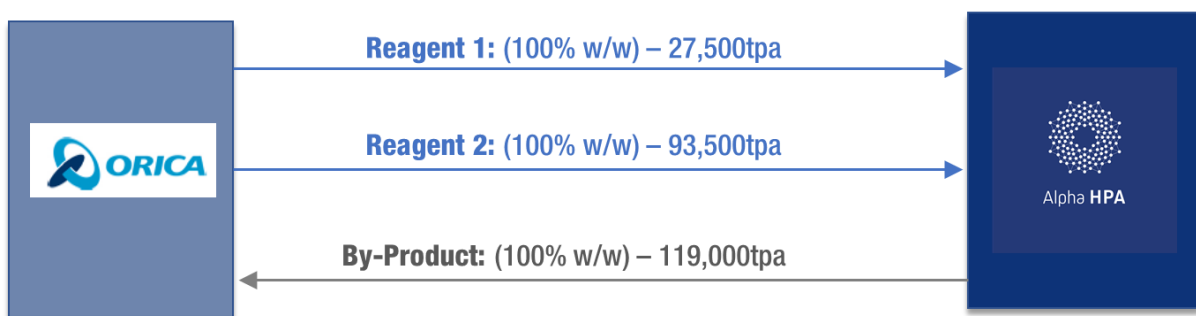

## 6. PROJECT LOCATION AND INFRASTRUCTURE

### 6.1 Gladstone State Development Area

The MOU with Orica was negotiated on the basis of reagents supply and by-product offtake delivered from/to Orica's facility in Gladstone, QLD, within the Gladstone State Development Area ('GDSA').

On this basis, Alpha HPA has secured an option with Economic Development Queensland ('EDQ') on a suitable 10ha land parcel within the GDSA, being Lot 12/SP239343 (see map below). Alpha HPA is now in final contract negotiation stage for land purchase with the EDQ.



Figure 4: HPA First Project Location – Gladstone QLD

The GDSA is located north-west of Gladstone and is a defined area of land dedicated for industrial development and materials transportation infrastructure. Comprising 27,194 hectares of land adjacent to the Port of Gladstone, with connections to major rail networks and Australia's national highway, the GDSA also provides suitable access to mains power, LNG and a diversely skilled local workforce. The GDSA already hosts a number of major industrial chemical projects, including:

- Rio Tinto alumina refinery;
- Orica chemical manufacturing complex;
- Transpacific Industries waste management and recycling facility;
- Australia Pacific LNG;
- Santos Gladstone LNG; and
- Queensland Curtis LNG.

## 6.2 Infrastructure and Utilities

The Project site within the GDSA is serviced by sealed roads, with access to 22kVa mains power, raw and potable water supply, natural gas mains, sewer and trade waste.

Power for the site is to be provided by Ergon Energy from an existing 22kV supply. The DFS electrical design includes three (3) motor control centre (MCC) substations, provided to distribute low voltage power to the individual equipment loads. Backup generators are provided for critical loads that need to keep running during power loss.

Water to be provided by the Gladstone Area Water Board. Two supplies are provided, process (raw) water and potable water. The largest user is process water for cooling tower make-up.

Natural Gas to be provided by Jemena through existing piping infrastructure.



*Figure 5: 3D Model – HPA first Project*

## 7. HPA FIRST PILOT PLANT

The HPA First Pilot Plant recorded over 600 hours of operating time and generated over 40kg of HPA for end-user qualification and vendor testwork.

The Pilot Plant represented the first time the flowsheet had been operated on a fully integrated basis and was able to:

- Demonstrate and validate the process steps of the aluminium extraction & refining process;
- finalise a detailed mass and energy balance for the HPA First process flow sheet;
- provide engineering data Design Criteria for the commercial facility;
- generate HPA product for evaluation by potential off-takers and project partners; and
- ensure impurities in recycle streams reach steady state



*Figure 6: HPA First Pilot Plant in Operation*

## 8. HPA QUALITY SPECIFICATIONS

The HPA First Pilot Plant was able to readily and reliably manufacture high purity alumina meeting the required quality specification for premium, high purity alumina for applications within either the sapphire glass/LED market, currently the dominant end-user market for HPA, or for use within lithium-ion batteries (LIB), the projected growth market driven substantially by the projected growth of e-mobility. The summary quality specifications for HPA are set out below:

### 8.1 Purity

The HPA First Project will produce >99.99% (>4N or 'four 9's') pure alumina. The ability of the process flow sheet deliver >4N purity alumina was well established during the Pilot Plant process, showing continuous purity improvement for the entire pilot operation, and achieving just short of 5N HPA. Purity was confirmed by the glow discharge mass spectroscopy analytical method on over 80 samples.



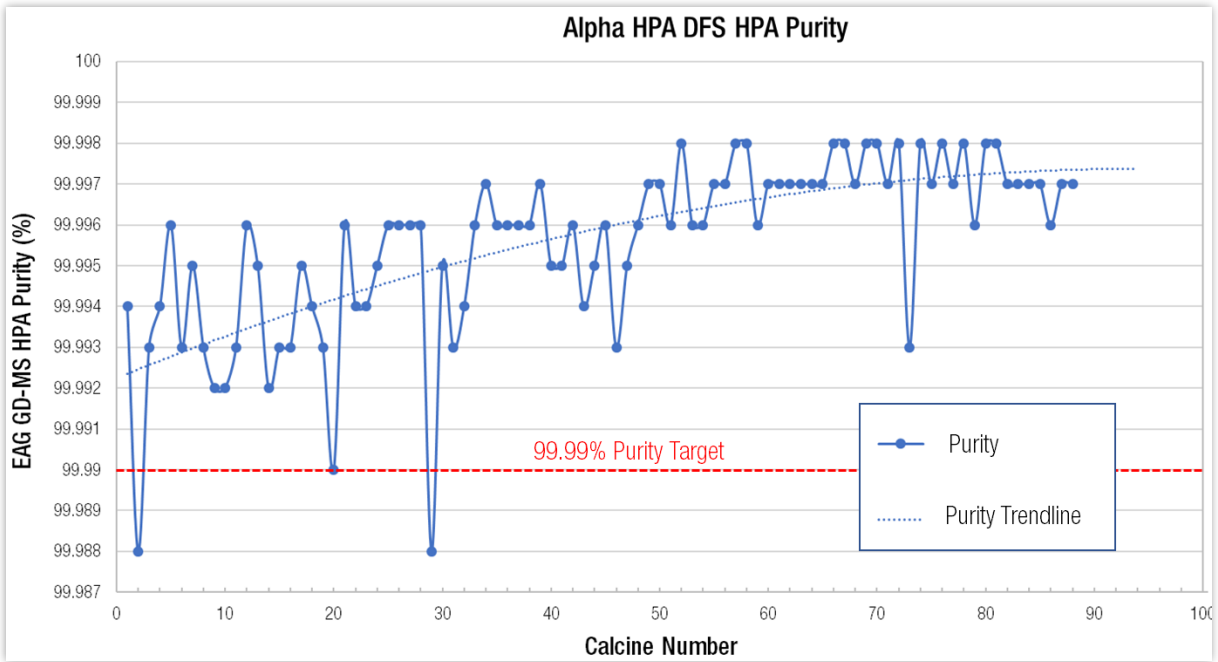

Figure 7: Progressive HPA purity performance on the HPA First Pilot Plant

## 8.2 Morphology and Crystal Form

To achieve the requisite density, specific surface area and inert electrical properties for application within LIB's, the HPA must be converted to alpha ( $\alpha$ ) crystal form. Alumina undergoes alpha crystal phase transition at approximately 1250°C, which represents the final calcination stage of the HPA First flow sheet. Calcination must achieve 100% phase transition to alpha alumina to achieve sale-able specifications. Under scanning electron microscopy (SEM) alpha form alumina manufactured in the Pilot Plant exhibits the desired 'dog bone' crystalline morphology (refer Figure 8)

## 8.3 Particle Size Distribution (PSD)

For HPA powder applications, principally coating applications on either separator films or LIB electrodes, a narrow, and specific PSD is required. The desired PSD is achieved in the jet milling stage (refer Section 10.7), where the HPA is autogenously milled to the required PSD.

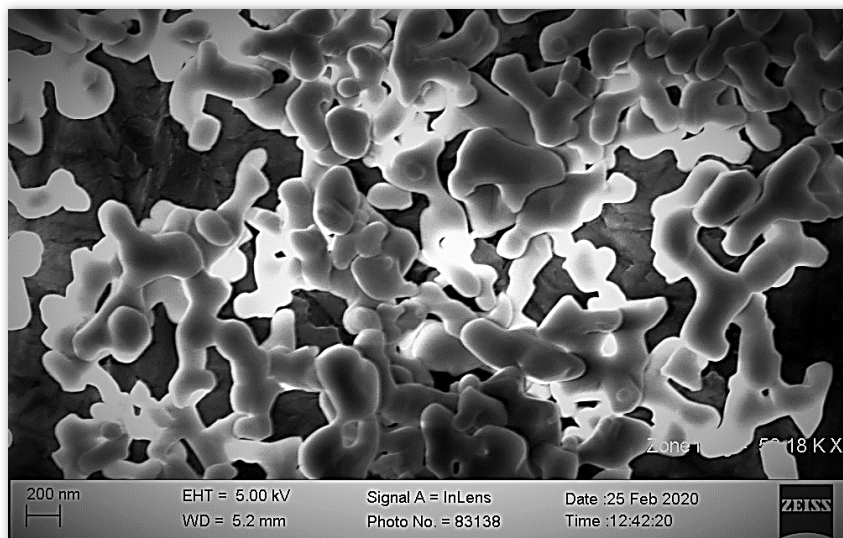

Figure 8: SEM Image – Alpha HPA alumina

## 9. PROCESS FLOW SHEET

The HPA First process flow sheet has been developed from a proprietary solvent extraction and refining technology licensed to a wholly owned subsidiary of Alpha HPA. The Company's licensor and technology partner has been closely engaged to direct all relevant process test work and process flow sheet development.

The key advantages of the Company's proprietary HPA process flow sheet over existing and proposed HPA process flow sheets are:

- the limited number of processing steps;
- process simplicity and the recycle of reagents as saleable by-products;
- wet chemical purification process at atmospheric temperature and pressures ahead of the drying and calcination stages; and
- the absence of chlorides or high temperature acid recovery.

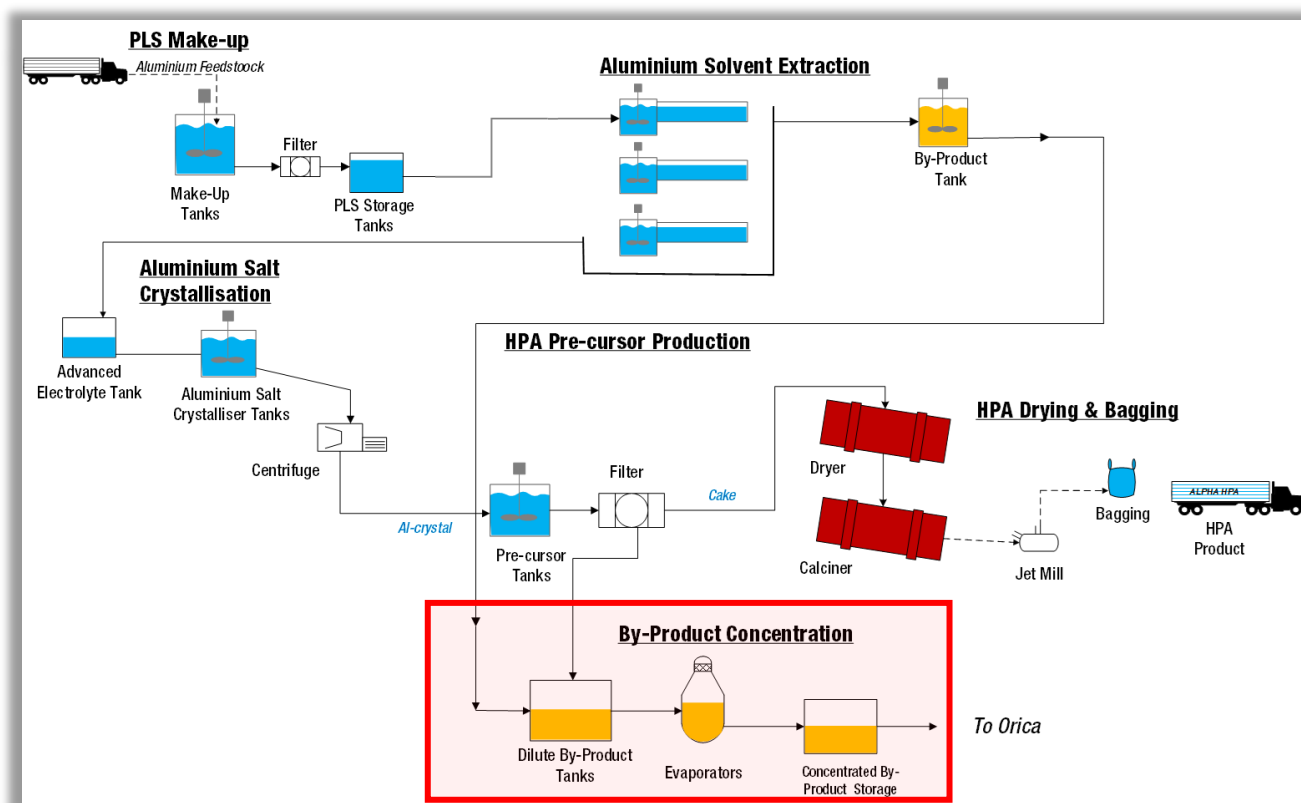

Figure 9: HPA First Process – Simplified Process Block Flow Diagram

## 10. KEY PROCESS STEPS

### 10.1 Feedstock and Feed Preparation (PLS Make-up)

The HPA First Project consumes approximately 18,600 tonnes of aluminium feedstock per annum. The feedstock is an internationally traded industrial commodity and Alpha HPA is currently in negotiation to purchase feedstock from a local Gladstone supplier with pricing referenced to published international indices.

The Pilot Plant was operated on two different bulk feedstocks, with no measurable impact on process stability or final HPA product quality.

The aluminium feedstock is prepared for the SX step as an aluminium bearing solution of approximately 5-6% Al, referred to as the pregnant liquor solution (PLS).

## 10.2 Aluminium Solvent Extraction (SX) and raffinate treatment

Aluminium is extracted from the PLS through a three stage counter-current SX process which delivers a high purity, aluminium loaded organic. The loaded organic is then washed, and the aluminium stripped into a high-purity aqueous aluminium solution, referred to as the advanced electrolyte. The stripped organic is recycled back to the aluminium extraction circuit.

## 10.3 Aluminium Salt Crystallisation

Advanced electrolyte from the SX circuit is stored in two quality assurance tanks prior to crystallisation. Each tank has eight hours residence time. Advanced electrolyte is cooled to precipitate very high-purity aluminium salt crystals as a batch process. The crystal slurry produced is centrifuged and sluiced with de-ionised water. The aluminium salt slurry is then sent to the HPA Pre-cursor production area.

The aluminium salt crystallisation stage represents a key purification step, with typically <10ppm impurities in the Al-salt crystals.



Figure 10: 21kg of high-purity aluminium salt, generated in the Pilot Plant over a 24 hour period

## 10.4 HPA Pre-Cursor Production

Aluminium salt is redissolved in a high purity aqueous solution and batch precipitated as HPA Pre-cursor. The HPA Pre-cursor is then filtered with the filtrate returned to the start of the HPA Pre-cursor circuit, and the Pre-cursor cake sent to the start of the drying circuit.



Figure 11: Pre-cursor Production in the HPA First Pilot Plant

## 10.5 By-Product Concentration

The two major process reagents are recycled to a by-product via the by-product concentration area. By-product is treated, concentrated and delivered back to the chemical counterparty (Orica) by pipeline.

## 10.6 Drying and Calcination

HPA Pre-cursor is indirectly dried to remove moisture and then calcined to alpha form HPA, prior to cooling and direction to the jet-milling circuit.

## 10.7 Jet Milling & Bagging

The jet mill circuit uses autogenous milling under compressed air to mill the material to the desired PSD ahead of bagging and shipping.

The DFS jet milling testwork was undertaken using a dedicated spiral type jet mill purchased and installed inside a specialist battery facility in Binghamton, NY USA.



Figure 12: Alpha HPA's Pilot jet Mill in Binghamton, USA

# 11. HPA MARKETING AND HPA PRICE ASSUMPTIONS

## 11.1 Introduction

Traditionally, HPA has been defined as  $\text{Al}_2\text{O}_3$  which is >99.99% ("4N") pure, although this distinction has been somewhat blurred due to the marketing practices of some Chinese producers and the inherent complexities in accurately measuring such low impurity levels. The generally understood terms in the market are now as follows:

- 99.9% = 3N HPA (equivalent to  $\leq 1000$ ppm impurities)
- 99.99% = 4N HPA (equivalent to  $\leq 100$ ppm impurities)
- 99.999% = 5N HPA (equivalent to  $\leq 10$ ppm impurities)

HPA is valued for its excellent properties in a number of areas, such as its chemical stability, very high melting point, high mechanical strength and hardness (especially as sapphire), good thermal conductivity and high electrical insulation.

HPA itself can be produced with several crystalline structures, known as alpha ( $\alpha$ ), theta ( $\theta$ ) and gamma ( $\gamma$ ), depending on the arrangement of their atoms.  $\gamma$ -crystals are produced during calcination at c.500°C, whereas  $\alpha$ -crystals are produced at c.1250°C. Alpha HPA's proprietary process is able to produce each of these various crystalline structures,



with a focus on the higher-value and more widely-sought alpha ( $\alpha$ ) crystal structure, which is most suited to light-emitting diode (“LED”) and lithium-ion battery (“LIB”) applications.

These represent the two broad consumer markets in which Alpha HPA is targeting to sell its product:

- The LED lighting market is the major incumbent consumer of sapphire, and has strong growth prospects – driven by ‘green’ factors such as energy efficiency and safe disposal, as well as the ongoing electrification of the planet that increases demand for lighting; and
- The LIB market has enormous growth potential, arising from the anticipated surge in electric vehicle (“EV”) production globally, alongside a push for higher energy density within these cells.

The growth outlook for both key markets is therefore robust, with increased environmental consciousness and governmental regulations underpinning an ongoing global transition to both EVs and more efficient, non-hazardous lighting. As demand from the two exceeds supply of high-quality HPA, an unexpected downturn in one of these industries would only make more HPA available to the other. In its study, CRU also identified a number of smaller markets, particularly for semiconductor crystal growth and the resulting circuitry’s thermal shielding, that have fairly strong prospects for future material consumption.

Each market also has its own demand dynamics that can result in various specifications of HPA, with differing physical characteristics and impurity levels greatly impacting the usability, value-in-use and the ultimate price for which the HPA is sold. The Alpha HPA product mix appears well-placed to service the distinct specifications of both the LIB and LED markets.

## 11.2 CRU

Alpha HPA has engaged an independent and global commodity market research firm, CRU Group, to conduct a thorough analysis of the global HPA market: including a breakdown of the existing market supply, demand, producer cost structure and achievable market prices, as well as a detailed forward projection of HPA supply, demand and pricing.

In addition to the CRU analysis, Alpha HPA has conducted its own market outreach program to connect directly with HPA end-users. While this program is currently ongoing, interactions to-date with potential end users is greatly assisting expectations on realisable HPA sales prices.

## 11.3 The LIB Market

LIBs are currently used in portable electronics such as mobile phones and laptops; however, their high energy density (energy contained vs weight) makes them ideal for use in the surging EV market. The total number of LIB cells is forecast to grow at a compound annual growth rate (“CAGR”) of 25.4% per year across the period from 2018 to 2028 (CRU).

Within these, HPA has established itself as one of the preferred ceramics for coating the polyolefin separator that sits between the anode and cathode. A ceramic coated separator, or “CCS”, is preferential to other forms of separator in a number of key areas:

- Improved heat distribution, meaning the separator has high thermal stability and remains intact during ‘hotspots’ that can occur in the cell;
- High puncture strength, which impedes the breakthrough of lithium metal whiskers or “dendrites” that would short-circuit the cell upon reaching the cathode;
- Excellent wettability, a key rate-determining (and therefore, cost) step in cell manufacturing;
- Comparative tests between CCS-bearing cells and those with standard separators showed a remarkable extension in cycle life; and



- Comparable or even improved permeability, thereby facilitating the safe ionic exchange between the anode and cathode, and so power output.

All of the above grow exceedingly important as cell manufacturers move to more energy-dense cell chemistries – a shift being brought about by the increasingly stringent specifications of EVs. More recently, HPA applications in the LIB cell have extended (albeit at an early stage) to direct coating of the anode and cathode, as well as more bespoke measures such as the pre-treatment of the electrode itself with nano-HPA particles.

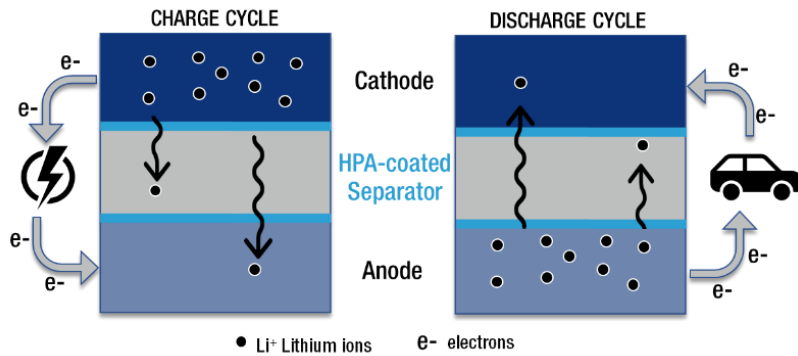

Figure 13: LIB Schematic – showing role of HPA as a separator coating

While the overall usage of HPA in LIB cells is expected to rapidly proliferate as more energy-dense batteries arrive to cater to the burgeoning EV market, purity requirements are also expected to increase, as reducing impurities within the cell is acknowledged to have a material, positive effect on cell performance – particularly, battery ageing (cycle life).

However, this requirement for purity is at odds with pressures on LIB cell manufacturers to reduce their costs, in order to improve the competitive offering of EVs over traditional engines. Therefore, the current LIB market for HPA remains *price elastic*: a number of LIB separator manufacturers and cell/electrode manufacturers are still opting for lower-price, lower-purity 3N HPA. As cycle life increases in importance for car purchasing habits (notionally, once a large number of users witness vehicle batteries reaching the end of their useful lives, CRU expects that it will rise significantly in manufacturer requirements, and so drive increased purchasing choices for 4N or even 5N HPA. The Company confirms that it is seeing rising interest in 4N purity from end-users currently using 3N HPA.

## 11.4 The LED Market

The LED market is the most established consumer of HPA (in the form of sapphire) today, and is continuing to exhibit its own favourable demand growth trajectory. This is underpinned by trends towards larger sapphire wafers which help to drive down LED production costs, and the creation of these larger wafers has led to ultra-low tolerances of impurities.

At a headline demand level, the continued global adoption of LED lighting – in particular, dynamic LED signs – is due to its greater energy efficiency, long lifespans, easier disposal and less complex production process than traditional incandescent and fluorescent lighting options.

Taking the headline demand and material choices trends together, CRU finds a 14% CAGR for LED units out to 2028, but a 20.7% CAGR for 4N HPA demand itself, adding more than 85,000 tonnes to demand over the course of a decade.

The CRU research also concludes that the sapphire glass market is far more price inelastic than most others. This is due to the relatively small cost of the sapphire wafer within the LED (especially when compared with competing substitute materials), as well as the value benefit from using higher quality HPA – lower material losses within the sapphire manufacturing process, which ultimately save the customers a considerable amount of cost.

## 11.5 HPA Demand

Based on its research into the HPA sector, CRU created a highly compelling unconstrained demand model profile, with an extraordinary CAGR of 31.6%, meaning that a market of just 35,000 tonnes in 2018 could top 500,000 tonnes in 2028. The vast majority of this material would be consumed in either the LED or LIB sectors.

However, given the high technical hurdles noted in the production of HPA, it is considered unreasonable for supply to scale up rapidly enough to meet this insatiable demand; moreover, the price warfare in such a scenario would clearly lead to demand destruction.

Therefore, CRU has prepared a more realistic 'supply-constrained' demand profile for 4N+ HPA, which instead shows a compound annual growth rate of 17.6%. Here, the market is in relative balance until 2020, after which deficits build through to a large, but more tolerable, projected supply deficit of nearly 30,000tpa by 2028. This is shown in the chart below:

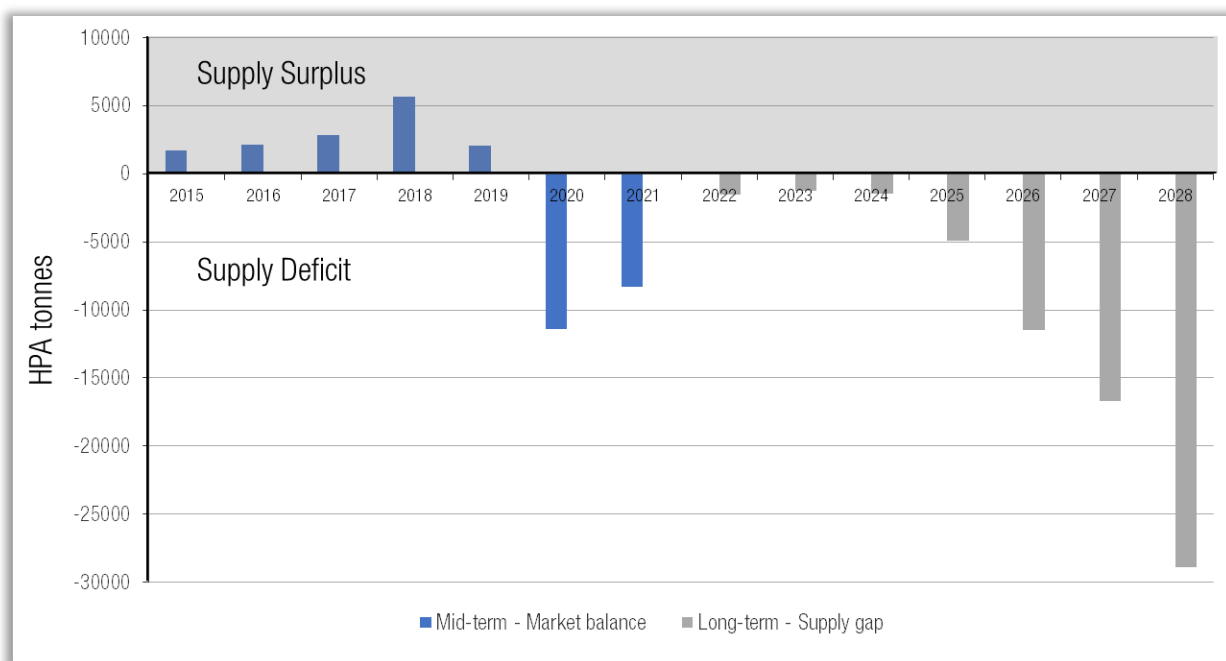

Figure 14: CRU – Market balance in a constrained scenario for 4N+ HPA

## 11.6 HPA Pricing

CRU completed a detailed analysis of historical and current 4N HPA market pricing, which included examination of international trade data, firm offers, and interviews with consumers, current producers, prospective producers and other market participants.

Based on this, CRU advised Alpha HPA that it could have reasonably expected to sell its intended product in 2018/19 for \$24/kg, assuming that the Company were in production and achieving its targeted specifications.

Combining this with its forecast view of supply, demand and costs, CRU estimated an average sales price for the Company's HPA over its first five years of production (2022-26) to be \$24.94/kg (nominal), or \$22.12/kg (real 2018). Looking out to 2028 in the constrained demand scenario, CRU forecast nominal 4N HPA prices to be in excess of \$30/kg.

In addition to the CRU analysis, Alpha HPA commenced its own market outreach program in 2019, which remains ongoing. Alpha's market outreach included an initial focus on end-users within the LIB supply chain – notably separator and electrode manufacturers. It also included engagement with battery research labs and electric vehicle

OEMs (original equipment manufacturers) to understand HPA's impact on cell performance, its quality tolerances, and the extent to which QA/QC tolerances are mandated within their supply chains.

The Company's outreach program to-date has included meetings with end-users in the USA, Germany, China, Japan and South Korea. Commercial samples of HPA generated from the Pilot Plant have been despatched to end-users in each of these jurisdictions, with a number of follow-up orders pending.

Alpha HPA has not yet engaged deeply with the sapphire glass / LED section of the market; however, the Company has commenced outreach to both Chinese and South Korean end-users in this market sector, with an initial order for commercial sample testwork from South Korea. Visits to a number of Chinese end users are pending. With the completion of this DFS and the availability of HPA material generated from the Pilot Plant, the Company plans a more aggressive market outreach campaign in the first half of 2020.

Direct price discussions between the Company and end-users has confirmed that a number of larger LIB separator manufacturers are buying higher-priced, 'high quality' (>4N) purity HPA for coating on their separators for 'premium' end-users, as well buying lower quality (3N) HPA material for separator coating for 'standard' separator products. End-users have described paying the 'premium price' for high-quality HPA, considered to be around the US\$24-25/kg referenced by CRU. LIB end-users quoted US\$5-US\$10/kg for 3N HPA, with most expressing interest in purchasing Alpha's 4N product if it could be discounted from the 'premium price'.

With the CRU detailed market report at hand, and the Company's own outreach programme ongoing and in its early stages with respect to the sapphire glass / LED market, this DFS takes the following position on pricing scenarios:

HPA Price Scenario	HPA Price	Rationale
Scenario 1	US\$25/kg	The current CRU pricing of US\$25/kg is accepted for Scenario 1 financial modelling
Scenario 2	US\$20/kg	An HPA price of US\$20/kg, based on the possibility that the Company may need to discount from the established premium 4N HPA pricing to penetrate supply chains in volume
Scenario 3	US\$15/kg	An HPA price of US\$15/kg, based on the possibility that the Company may need to further discount from the established premium 4N HPA pricing to penetrate supply chains in volume

Figure 15: HPA Pricing Scenarios

## 12. PROJECT PERMITTING AND APPROVALS

Alpha HPA has engaged AECOM consultants on all aspects of Project permitting and approvals. The summary project approvals to be obtained are set out on the table below:

Legislation	Approval	Trigger	Required	Next steps
<i>Environment Protection and Biodiversity Conservation Act 1999</i>	EPBC Referral / Approval	Significant impact on MNES	To be determined – further assessment required.	<ul style="list-style-type: none"> <li>Ecology survey to identify potential MNES values.</li> <li>Assessment of potential impacts to receiving environment associated with the World Heritage Area and the National Heritage Place.</li> </ul>
<i>State Development and Public Works Organisation Act 1971</i>	SDA Approval	Material Change of Use (Impact Industry)	Yes.	<ul style="list-style-type: none"> <li>Pre-lodgement meeting with Coordinator-General to discuss triggers.</li> </ul>
		Operational works (Vegetation Clearing)	To be determined – exemption may apply	
<i>Planning Act 2016</i>	Development Permit (Material Change of Use)	Concurrence ERA	To be determined - ERA types to be confirmed.	<ul style="list-style-type: none"> <li>Pre-lodgement meeting with Department of State Development, Manufacturing and Planning to discuss triggers.</li> </ul>
		Hazardous Chemical Facility	To be determined – chemical types and volumes to be confirmed.	
		Contaminated Land	To be determined – design dependant*.	
<i>Environmental Protection Act 1994</i>	Environmental Authority	Operating an ERA	To be determined - ERA types to be confirmed.	<ul style="list-style-type: none"> <li>Pre-lodgement with Department of Environment and Science</li> <li>Baseline assessments for environmental values and impact assessment of project on environmental values</li> </ul>
<i>Workplace Health and Safety Act 2011</i>	Major Hazard Facility Licence	Storing and / or using greater than 10% of Schedule 15 chemicals	To be determined – chemical types and volumes to be confirmed.	<ul style="list-style-type: none"> <li>Consultation with HICB</li> <li>Form 69 – Notification of a facility exceeding 10% of Schedule 15 threshold</li> </ul>

\* A contained land assessment would likely be required as due diligence (possibly in the lease stage) as the site is on the EMR/CLR.

Table 4: Matrix of Project Approvals

## 13. PROJECT SCHEDULE

A project implementation schedule has been updated and a summary schedule is shown in Figure 16. The critical path for the project is the delivery of the long lead equipment.

Key schedule basis and assumptions:

- EPCM delivery structure
- Regulatory approval in September 2020
- Financial approval shortly after regulatory approval
- A maximum delivery period of 15months for long lead equipment
- Civil and structural work commence prior to the delivery of long lead equipment

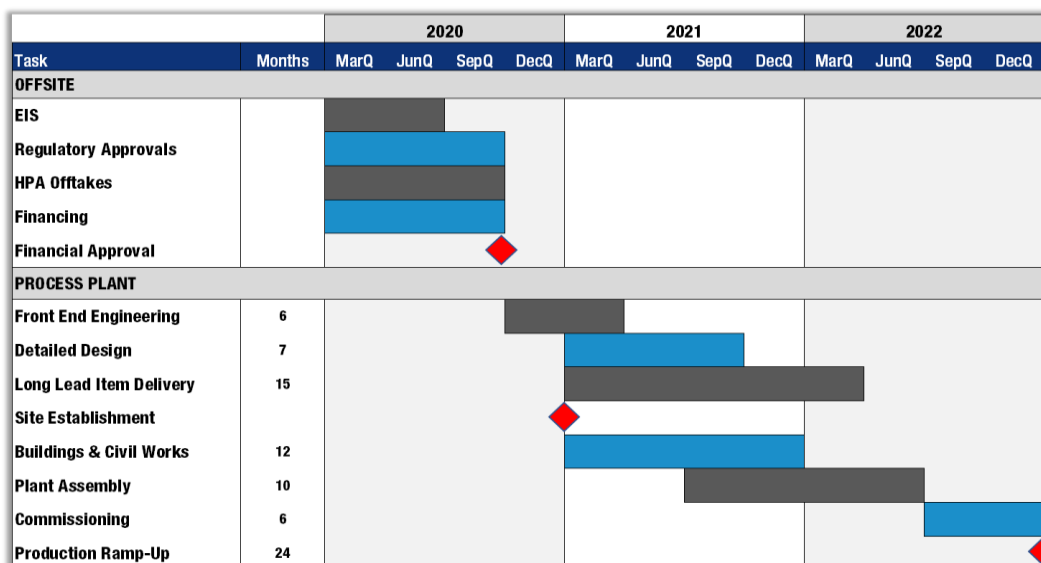

Figure 16: Project Implementation Schedule

## 14. PROJECT SENSITIVITIES

Project EBITDA sensitivities are presented below as Figure 17 and Figure 18, below.

The Project is most sensitive to HPA price received, and financially robust down to HPA prices as low as US\$10,000/tonne.

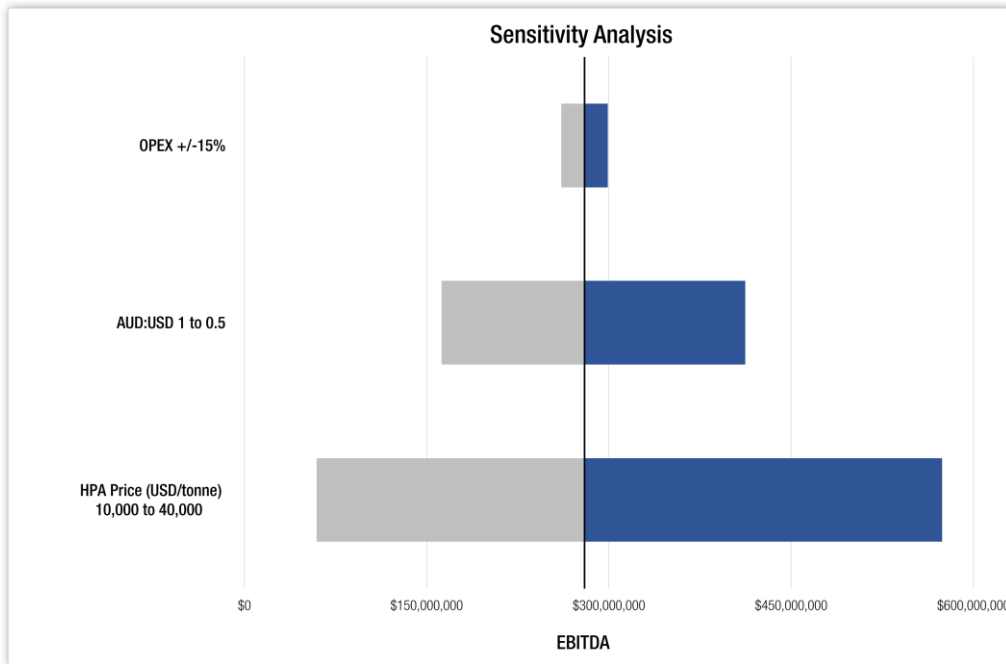

Figure 17: Tornado Diagram – EBITDA sensitivities

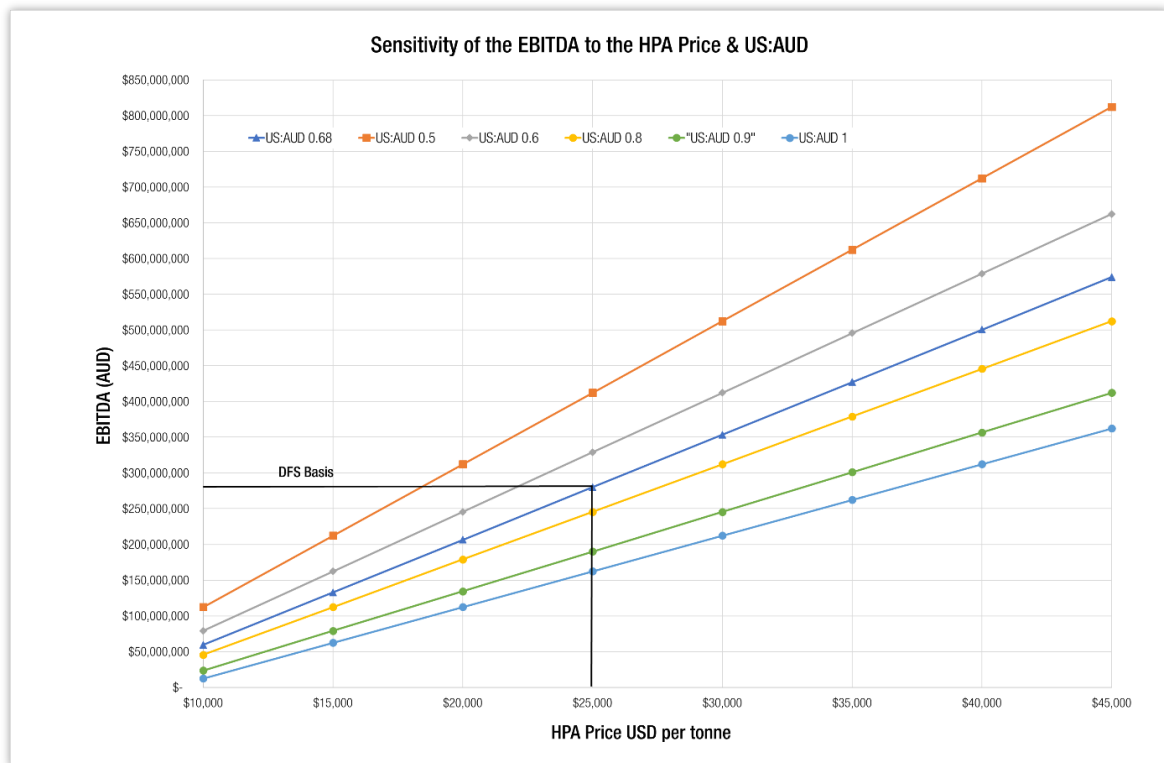

Figure 18: EBITDA sensitivities to HPA price and USD:AUD

## 15. PFS VS DFS

DFS estimates are compared below with revised with the Pre-Feasibility Study (PFS): (ASX announcement 7 March 2019)

### 15.1 OpEx

At full production rate, and before by-product credits, the DFS recognises a reduction in annual operating costs, of A\$15.1M per annum, from \$142.6Mpa (March '19 PFS) to \$127.5Mpa (DFS). The reduction is almost entirely recognised in a reduction in key reagent pricing assumptions, notwithstanding increased reagent volumes in the DFS.

The pricing mechanisms for key process reagents and the by-product have been negotiated with Orica as a combined commercial agreement. Favourable reagent pricing in the DFS are in part offset by reduced by-product pricing, and the impact of reducing US:AUD FX assumptions from 0.75 to 0.68.

In addition, the annual production rate has been reduced from 10,200 to 10,000tpa of HPA, with a corresponding minor increase in unit cost of production.

	PFS March 2019	DFS March 2020	Delta
<b>Annual Operating Costs (AUD)</b>			
Fixed + Variable Costs (AUD)	\$142.6 million	\$127.5 million	(\$15.1 million)
<b>Unit Costs (per tonne HPA)</b>			
Before By-Product Credits (AUD)	\$13,983	\$12,750	(\$1,233)
Before By-Product Credits (USD)	\$10,487	\$8,670	(\$1,877)
After By-Product Credits (AUD)	\$6,830	\$8,730	\$1,900
After By-Product Credits (USD)	\$5,123	\$5,936	\$813
USD:AUD	0.75	0.68	

Table 5: HPA First Project OpEx: DFS vs PFS

### 15.2 CapEx

Headline CapEx has increased from the PFS to DFS from A\$198M (US\$149M) to \$308M (US\$209M).

Dominant contributors to delta between DFS and PFS capex estimates are set out below:

- Negative FX adjustment, principally
  - USD:AUD which was adjusted from 0.75 to 0.68
  - EUR:AUD which was adjusted from 0.63 to 0.61
- Additional unit operations. Additional process steps have been included, principally the treatment of PLS and by-product treatment steps
- Tank storage has increased across the Project to allow for redundancy and surge capacity to manage supply or quality assurance in the process
- Increased electrical costs
- Switch to higher quality vendors for SX and drying circuits
- Higher infrastructure and connections costs to chemical counterparty
- Increased volume and costs for first fill reagents

## 16. OPPORTUNITIES

The Company is delighted with the DFS completion and current findings. However, and in addition, some further significant technical and commercial opportunities for the project will be investigated in the coming months:

- The CapEx estimate includes \$25.3M (\$30.0M including Indirects) associated with the by-product concentration area (marked in a red box in Figure 7). The location and capital expenditure for this area remains subject to final engineering and evaluation with Orica, which may result in a CapEx adjustment and an attendant time-dated OpEx amortisation adjustment.
- The HPA Pilot Plant has recently successfully produced an alternative ceramic coating product, being high purity (4N) boehmite (Al-O-OH). The Company is in active discussions with end-users in the lithium-ion battery (LIB) supply chain regarding boehmite and will be shortly sending boehmite samples to these end-users for qualification testing. The addition of boehmite to the HPA First process provides excellent flexibility to produce alternative products based on end-user demand.
- Post the completion of the DFS Pilot Plant campaign, the Company commenced testwork on the integration of a spray drying step following the HPA Pre-cursor production. Early results infer the potential to modify the drying configuration incorporated in the DFS design, with potential for CapEx reductions and reduced jet milling duty.

For further information, please contact:

Rimas Kairaitis  
Managing Director  
[rkairaitis@alphaHPA.com.au](mailto:rkairaitis@alphaHPA.com.au)  
+61 (0) 408 414 474

Cameron Peacock  
Investor Relations & Business Development  
[cpeacock@alphaHPA.com.au](mailto:cpeacock@alphaHPA.com.au)  
+61 (0) 439 908 732

pjn10287

### About the HPA First Project

The Company's HPA First Project represents the evaluation and intended commercialisation of the production of ~10,000tpa of high purity alumina (HPA) using the Company's proprietary licenced solvent extraction and HPA refining technology. The technology provides for the extraction and purification of aluminium from an industrial feedstock to produce 4N (>99.99% purity) alumina for the intended use within the lithium ion battery and LED lighting industry. Following a successful testwork program and completion of a Pre-Feasibility Study (PFS), updated in March 2019, Alpha HPA has now completed the DFS based on successful completion of its Pilot Plant program at its dedicated laboratory facility in Brisbane.

The Company has commenced full permitting, market outreach and project financing processes, with the expectation of positioning the HPA First Project to Final investment Decision.



## **Competent Person Statement (Process Development Testwork)**

Information in this announcement that relates to metallurgical results is based on information compiled by or under the supervision of Dr Stuart Leary, an Independent Consultant trading as Delta Consulting Group. Dr Leary is a Member of The Australasian Institute of Mining and Metallurgy. Dr Leary has sufficient experience to the activity which he is undertaking to qualify as a Competent Persons under the 2012 Edition of the 'Australasian Code for reporting of Exploration Results, Mineral Resources and Ore Reserves'. Dr Leary consents to the inclusion of the technical data in the form and context in which it appears.

For further information on testwork results and processes see ASX announcements dated 23 December 2019, 10 December 2019, 10 October 2019, 23 September 2019, 28 August 2019, 5 August 2019, 25 July 2019, 2 July 2019, 1 July 2019, 3 June 2019, 17 April 2019, 7 March 2019, 4 December 2018, 20 November 2018, 6 September 2018, 31 August 2018, 9 July 2018, 30 April 2018, 26 April 2018, 21 March 2018, 6 March 2018, 21 February 2018, 8 December 2017, 30 November 2017, 29 November 2017, 24 November 2017 and 13 November 2017.

## **Cautionary Statement**

The Definitive Feasibility Study (DFS) referred to in this announcement has been undertaken to assess the technical and financial viability of the HPA First project. The DFS is based on the material assumptions about the availability of funding and the pricing received for HPA. While the Company considers all of the material assumptions to be based on reasonable grounds, there is no certainty that they will prove to be correct or that the outcomes indicated by this DFS will be achieved. To achieve the range of outcomes indicated in the DFS, additional funding will be required. Investors should note that there is no certainty that the Company will be able to raise the amount of funding when needed. It is also possible that such funding may only be available on terms that may be dilutive to or otherwise affect the value of the Company's existing shares. It is also possible that the Company could pursue other 'value realisation' strategies such as a sale, partial sale or joint venture of the HPA First project. If it does, this could materially reduce the Company's proportionate ownership of the HPA First project. Given the uncertainties involved, investors should not make any investment decisions based solely on the results of the DFS.

## **Forward Looking Statements**

This DFS contains certain forward-looking statements with respect to the financial condition, results of operations, and business of the Company and certain plans and objectives of the management of the Company. These forward-looking statements involve known and unknown risks, uncertainties and other factors which are subject to change without notice and may involve significant elements of subjective judgement and assumptions as to future events which may or may not occur. Forward-looking statements are provided as a general guide only and there can be no assurance that actual outcomes will not differ materially from these statements. Neither the Company, nor any other person, give any representation, warranty, assurance or guarantee that the occurrence of the events expressed or implied in any forward-looking statement will actually occur. In particular, those forward-looking statements are subject to significant uncertainties and contingencies, many of which are outside the control of the Company. A number of important factors could cause actual results or performance to differ materially from the forward looking statements. Investors should consider the forward looking statements contained in this DFS in light of those disclosures.

The announcement is for information purposes only. Neither this announcement nor the information contained in it constitutes an offer, invitation, solicitation or recommendation in relation to the purchase or sales of shares in any jurisdiction. The announcement may not be distributed in any jurisdiction except in accordance with the legal requirements applicable in such jurisdiction. Recipients should inform themselves of the restrictions that apply to their own jurisdiction as a failure to do so may result in a violation of securities laws in such jurisdiction. This announcement does not constitute investment advice and has been prepared without considering the recipients investment objectives, financial circumstances or particular needs and the opinions and recommendations in this announcement are not intended to represent recommendations of particular investments to particular persons. Recipients should seek professional advice when deciding if an investment is appropriate. All securities' transactions



involve risks, which include (among others) the risk of adverse or unanticipated market, financial or political developments. To the fullest extent of the law, Alpha HPA Limited, its officers, employees, agents and advisors do not make any representation or warranty, express or implied, as to the currency, accuracy, reliability or completeness of any information, statements, opinion, estimates, forecasts or other representations contained in this announcement. No responsibility for any errors or omissions from the announcement arising out of negligence or otherwise is accepted.

## Appendix 1:

### SUMMARY OF MATERIAL ASSUMPTIONS

The key assumptions relevant to the financial analysis are;

Item	Assumption	Commentary
A\$/US\$ Exchange Rate	A\$1.00 = US\$0.68	Based on 12-month average and market consensus analysis
HPA sales price	US\$25/kg US\$20/kg US\$15/kg	Alpha HPA has modelled 3 pricing scenarios for HPA, based on detailed marketing research by CRU and the Company's own market outreach program.
Reagent & by-product pricing	<Confidential>	Reagent and by-product pricing are based off pricing and volume formulas set out in a MOU with Orica Australia (ASX Announcement: 10 Feb 2020).
Construction Commencement	CY2021	Based on reasonable assumptions for completion of financing and project permitting and delivery of long-lead items
Initial Production	Late CY2022	Initial Production from commissioning activities. Based on conservative estimates for construction completion
Production Ramp-Up	2 years 52% nameplate: Year 1 92% nameplate: Year 2	Based on Prudentia experience of hydrometallurgical process plant ramp-up and McNulty curves
Sustaining Capital Requirements	1% of CapEx: Years 2-7 2% of CapEx: Years 7-14 2.5% of CapEx: >14 years	Typical for similar process plants
Pre-Production Operating Expenses	Construction Year 1: 2% of Capital Construction Year 2: 3% of Capital	Typical for similar process plants

### SUMMARY OF MODIFYING FACTORS

Criteria	Commentary
Study Status	<p>The HPA First Project DFS indicates the project is technically and financially viable. The Study was completed by Prudentia Process Consulting, with input from the Company and other specialist consultants.</p> <p>The activities and findings of all other disciplines are summarised in the DFS document, and detail derivation of other modifying factors such as processing recoveries, costs, revenues, government and permitting.</p> <p>Overall the results of the DFS demonstrate that the HPA First Project is technically and financially robust.</p>
Mining factors or assumptions	The HPA First Project DFS does not assume any material sourced from a mining operation
Processing (including Metallurgical factors or assumptions)	<p>The production of HPA using a Solvent Extraction (SX) based process is a novel process flow sheet.</p> <p>The process plant design can be summarised by the following sequential activities:</p> <ul style="list-style-type: none"> <li>The preparation of the industrial feedstock and PLS</li> </ul>

Criteria	Commentary
	<ul style="list-style-type: none"> <li>• Solvent extraction of the feedstock solution to produce an aluminium strip liquor and aqueous solution of dilute by-product (raffinate).</li> <li>• Crystallisation of the aluminium salt from aluminium loaded strip liquor.</li> <li>• Production of HPA pre-cursor and additional generation of by-product</li> <li>• Calcining of HPA pre-cursor to HPA, micronizing (jet milling) and packaging.</li> <li>• Evaporation circuit to concentrate by-product for sale</li> </ul> <p>The process flow sheet has been validated for the purposes of the DFS through the following testwork:</p> <ul style="list-style-type: none"> <li>• Over 600 hours of Pilot Plant operation</li> <li>• Demonstrated process stability over a range of operating conditions, including the trialling of alternative feedstocks</li> <li>• Production of over 40kg of HPA meeting &gt;99.99% purity</li> </ul>
<b>Environmental and Permitting</b>	<p>Alpha HPA has engaged AECOM to assist with the environmental and regulatory approvals.</p> <p>At the time of this report, AECOM are preparing Pre-Lodgement Documentation as the first step in a full-scale permitting process.</p>
<b>Financial</b>	<p>Project costs have been estimated by Prudentia PC on the basis below.</p> <p><b>CapEx:</b> The capital cost estimate is provided at an accuracy level of -10% to +15%. The capital cost estimate has been based on the implementation of an EPCM contracting strategy.</p> <ul style="list-style-type: none"> <li>• Pricing for mechanical equipment and packages are based on budget quotes sourced from reputable vendors or recent internal database information and scaled accordingly</li> <li>• Contingency of <b>10% of the direct and indirect costs</b> has been added to the total reflecting the status of engineering, maturity of the process technology and data contained within this DFS</li> <li>• No allowance for taxes, import duties, value added tax (VAT), goods and services tax (GST) and the like was made</li> </ul> <p>The Project Capital Cost is estimated based on: multiple vendor quotes for equipment, material take-offs for piping, electrical and instrumentation, civil works &amp; structural steel, contractor labour quotes for on-site construction activities, and first principles build-ups for indirect costs such as EPCM, first fills &amp; owners costs. Over 84% of mechanical pricing is based on vendor budget quotes with the remainder a mix of Prudentia database, internal estimates, factored estimates, sourced data and allowances.</p> <p><b>OpEx:</b> The operating cost estimate has been calculated based on a first principle build-up including reagents, utilities, consumables, labour, general expenses, maintenance and contract services to operate the plant. The operating costs were apportioned into fixed costs and variable costs with adjustments made to variable costs in the financial model for annual tonnage with ramp-up. Labour costs have been built up from an organisational chart typical of a processing facility of this scale and type.</p> <p>The annual operating costs at year 3 (full ramp-up) are summarised in Table 3, above, and are considered accurate to -10% to +15%.</p> <p><b>Sensitivities:</b> Sensitivity cases were considered by flexing key model inputs including sale price, operating costs and foreign exchange. The sensitivity analysis has been reported in EBITDA as there is no mine limiting the HPA First Project</p>

Criteria	Commentary
	<p>life. As expected with the operating margin the project is most sensitive to changes in the HPA product price in comparison to the other sensitivity factors modelled. Foreign exchange has the next biggest impact on the Project's EBITDA because the HPA price is traded in USD. The Project is fairly resilient to changes in operating cost.</p>
<b>Marketing</b>	<p>Alpha HPA commissioned the independent research group CRU to complete an HPA market study. The key conclusions of the study included:</p> <ul style="list-style-type: none"> <li>• the market is in relative balance until 2020, after which deficits build through to a large, but more tolerable, projected supply deficit of nearly 30,000tpa by 2028.</li> <li>• CRU estimated an average sales price for the Company's HPA over its first five years of production (2022-26) to be \$24.94/kg (nominal), or \$22.12/kg (real 2018). Looking out to 2028 in the constrained demand scenario, CRU forecast nominal 4N HPA prices to be in excess of \$30/kg.</li> </ul>
<b>Social, legal and Governmental</b>	<p>The Company is advised by AECOM consultants with respect to government permitting and environmental studies.</p>