



**Factor Therapeutics Limited 2021 Annual General Meeting  
Chairman's Address and Presentation from PowerLime, Inc.**

**Brisbane (Australia) 28 May 2021:** Factor Therapeutics Limited (ASX:FTT) ("Factor" or "the Company") is pleased to provide the Chairman's Address to the Annual General Meeting of Shareholders being held today from 1.00pm (AEST) (AGM). In addition, the Company provides a presentation from PowerLime, Inc., which will also be presented to the AGM.

Due to the developments in relation to the COVID-19 situation, this year the AGM is being held as a virtual meeting. The virtual AGM can be accessed at <https://agmlive.link/FTT21>.

**CHAIRMAN'S ADDRESS**

Good morning, Shareholders and colleagues. Welcome to the 2021 Annual General Meeting of Factor Therapeutics Limited.

I would like to start this address by saying that the Board is very pleased to be bringing the PowerLime opportunity to Shareholders. Although this transaction would present a shift in activities from life sciences to resources, the Board believes this is the right business opportunity to bring to Shareholders.

We have continuously updated the market on the Board's strategy and efforts to bring to Factor a suitable and compelling opportunity with the potential to bring Shareholder value and return.

The Board set a high bar in terms of determining the scope and suitability of an opportunity, and the time taken in these efforts is reflective of a number of factors including the time required to diligence potential new business opportunities, working with the Company's many stakeholders, and working through complexities associated with seeking to have Factor relisted.

Between thirty and forty possible opportunities have been reviewed in these efforts, and some promising candidates progressed to deep due diligence and term sheet stage, as has been documented.

We fully hope that the opportunity we will be presenting today, the PowerLime opportunity, will come to Shareholders for vote in the near future through an EGM, with an associated re-listing application process with the ASX aiming to bring the Company out of suspension and trading again as soon as possible.

As Shareholders know, the Board has been judicious in the deployment of the Company's financial resources demonstrated by our strong cash position as recorded at 31 March 2021.

We have kept costs to a minimum and have leveraged the expertise of the Board to conduct diligence activities. Our goal has been to keep our capital as intact as possible to maximise the possibility that your Company has the financial resources to kick-start a new commercial opportunity.



As we have previously discussed with Shareholders, the Board had considered whether the best course of action would be to return capital to Shareholders. The feedback from Shareholders was appreciated in support of finding a new opportunity for the Company, and although the Board primarily considered opportunities in the life sciences, biotech and medtech areas, we have also always considered proposals outside of our immediate field of expertise.

This review outside of life sciences came with the understanding that such a transaction could lead to a Board transition and the appointment of directors with the requisite skills and experience needed to drive the new business to maximise value for Shareholders.

On 20 April 2021, Factor signed a non-binding term sheet with PowerLime, Inc., a company which holds an option to acquire land located in Early County, South Georgia, USA, to explore and develop an advanced high calcium limestone project.

The term sheet is non-binding and remains subject to necessary regulatory approvals and receipt by Factor of in-principle advice from ASX which has been sought and at today's date remains pending.

I will shortly ask Mr Dominic Allen as a director of PowerLime Inc, and a member of the Apollo Group, to provide a presentation on the opportunity.

In conjunction with the transaction announcement of 20<sup>th</sup> April, we announced that Dr Christian Behrenbruch would not seek re-election and hence retires from the Factor Board at the close of this Meeting. Chris's decision to retire is reflective of the potential change in proposed commercial direction for the Company.

I will take this opportunity to repeat my comments from the April ASX announcement that Chris's contribution to the Company during his tenure cannot be overstated, and his fellow directors will always be grateful for the expertise and work ethic that Chris brought to the Board, driven by a deep commitment to deliver value to shareholders. On behalf of the Board, I thank Chris again for his contribution and we wish him the very best in all respects.

I am now going to ask Dominic Allen to take you through the presentation on the PowerLime opportunity.

After this presentation, we will take general questions about the transaction, to the extent we can answer these at this point in time, and then move to the formal agenda of the meeting.

-ENDS-

For further information:  
Dr David Brookes  
Chairman, Factor Therapeutics Limited  
via [m.farris@factor-therapeutics.com](mailto:m.farris@factor-therapeutics.com)

**POWERLIME**

FACTOR THERAPEUTICS AGM  
PRESENTATION

MAY 2021



### **Forward Looking Statements**

Information included in this release constitutes forward-looking statements. Often, but not always, forward looking statements can generally be identified by the use of forward looking words such as “may”, “will”, “expect”, “intend”, “plan”, “estimate”, “anticipate”, “continue”, and “guidance”, or other similar words and may include, without limitation, statements regarding plans, strategies and objectives of management, anticipated production or construction commencement dates and expected costs or production outputs.

Forward looking statements inherently involve known and unknown risks, uncertainties and other factors that may cause the Company’s actual results, performance, and achievements to differ materially from any future results, performance or achievements. Relevant factors may include, but are not limited to, changes in commodity prices, foreign exchange fluctuations and general economic conditions, increased costs and demand for production inputs, the speculative nature of exploration and project development, including the risks of obtaining necessary licenses and permits and diminishing quantities or grades of reserves, political and social risks, changes to the regulatory framework within which the company operates or may in the future operate, environmental conditions including extreme weather conditions, recruitment and retention of personnel, industrial relations issues and litigation.

Forward looking statements are based on the Company and its management’s good faith assumptions relating to the financial, market, regulatory and other relevant environments that will exist and affect the Company’s business and operations in the future. The Company does not give any assurance that the assumptions on which forward looking statements are based will prove to be correct, or that the Company’s business or operations will not be affected in any material manner by these or other factors not foreseen or foreseeable by the Company or management or beyond the Company’s control.

Although the Company attempts and has attempted to identify factors that would cause actual actions, events or results to differ materially from those disclosed in forward looking statements, there may be other factors that could cause actual results, performance, achievements or events not to be as anticipated, estimated or intended, and many events are beyond the reasonable control of the Company. Accordingly, readers are cautioned not to place undue reliance on forward looking statements. Forward looking statements in these materials speak only at the date of issue. Subject to any continuing obligations under applicable law or any relevant stock exchange listing rules, in providing this information the company does not undertake any obligation to publicly update or revise any of the forward looking statements or to advise of any change in events, conditions or circumstances on which any such statement is based.

### **Cautionary Statements and Important Information**

This presentation has been prepared by the Company as a summary only and does not contain all information about assets and liabilities, financial position and performance, profits and losses, prospects, and the rights and liabilities attaching to securities. Any investment in the Company should be considered speculative and there is no guarantee that they will make a return on capital invested, that dividends would be paid, or that there will be an increase in the value of the investment in the future.

The Company does not purport to give financial or investment advice. No account has been taken of the objectives, financial situation or needs of any recipient of this presentation. Recipients of this presentation should carefully consider whether the securities issued by the Company are an appropriate investment for them in light of their personal circumstances, including their financial and taxation position.

### **Competent Persons Statement**

The information in this presentation that relates to Exploration Results is based on, and fairly represents, information compiled or reviewed by Mr Lamont Leatherman, a Competent Person who is a Registered Member of the ‘Society for Mining, Metallurgy and Exploration’, a ‘Recognised Professional Organisation’ (RPO). Mr Leatherman is a consultant to the Company. Mr Leatherman has sufficient experience that is relevant to the style of mineralization and type of deposit under consideration and to the activity being undertaken to qualify as a Competent Person as defined in the 2012 Edition of the ‘Australasian Code for Reporting of Exploration Results, Mineral Resources and Ore Reserves’. Mr Leatherman consents to the inclusion in the presentation of the matters based on his information in the form and context in which it appears.



### ADVANCED PROJECT

Advanced high calcium limestone project in the heart of the Georgia agricultural belt



### END MARKETS

Close proximity to local end markets, replacing lime imported from other US states



### INFRASTRUCTURE & COST ADVANTAGE

World class access to infrastructure including rail, road and power in a low-cost operating jurisdiction



### DOWNSTREAM VALUE

Potential downstream value through production of quick or hydrated lime



### LOW-COST DEVELOPMENT

Potential for very low capital costs, operating costs due to the simple nature of the deposit

## Opportunity for a high calcium limestone development and exploration project in the Southern USA

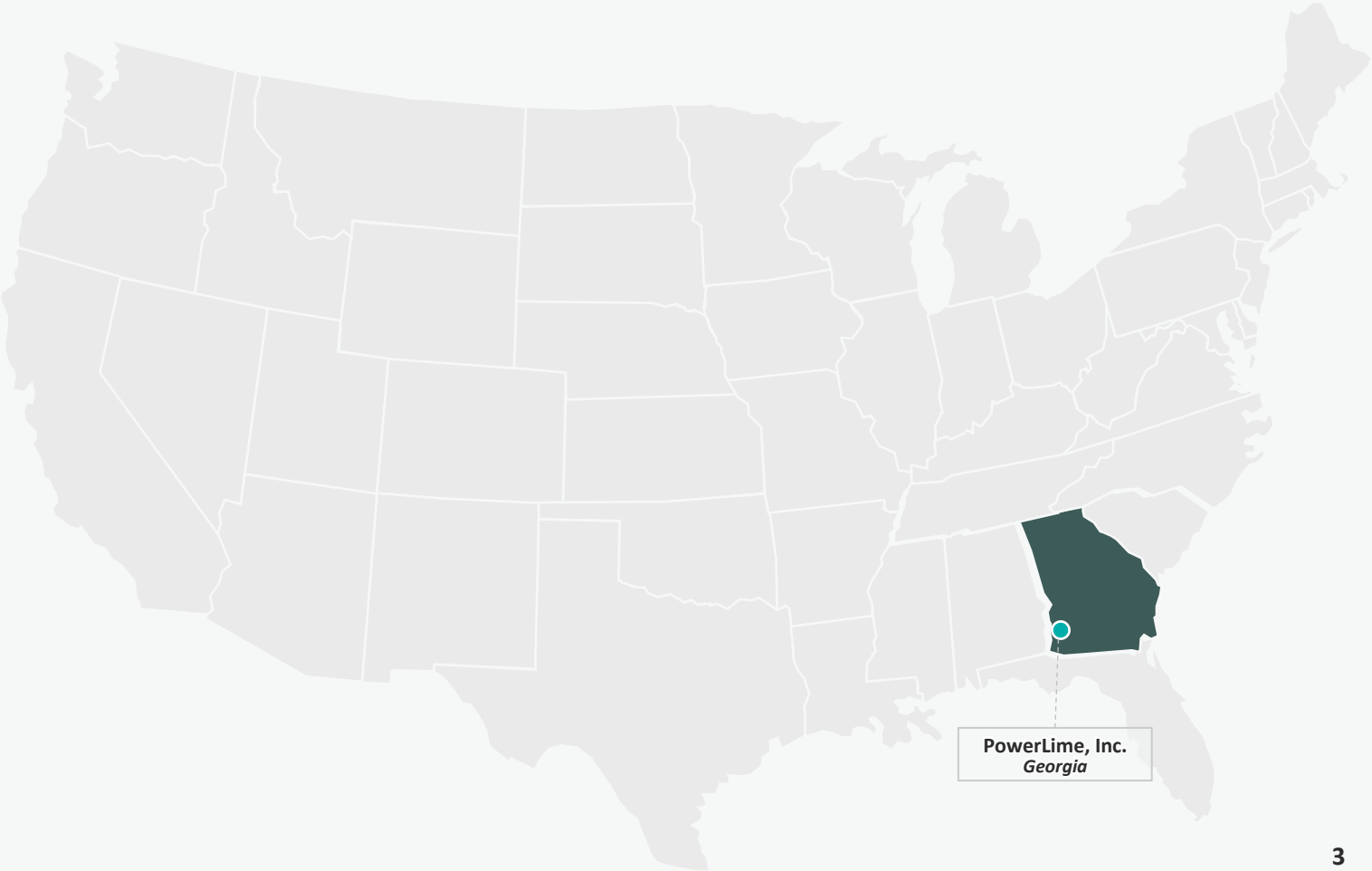



# Project Overview

- Option to acquire 361-acre property outside of Blakely in southern Georgia
- Potential for high quality limestone which is anomalous to the area
- Excellent access to rail, natural gas, power and low-cost labour – major rail running through property
- Significant work undertaken by PowerLime since incorporation in 2019
- Field work complete to submit a jurisdictional determination request to the US Army Corps of Engineers (commence permitting)



# End Markets & Product Sales

- The company is investigating sales to major end users within 250 miles of the project.
- Applicable industries include the Ag Lime market, Scrubber market and Glass market.
- Initial discussions underway with major U.S. commodity traders.

AG LIME	SCRUBBER	GLASS
<div data-bbox="186 882 435 943" style="border: 1px dashed black; padding: 2px;">MAJOR END USER</div> <div data-bbox="504 868 835 943" style="margin-left: 100px;">  </div> <ul style="list-style-type: none"> <li>▪ Used to increase soil pH, which can increase crop yields.</li> <li>▪ Often used to improve the physical structure of the soil.</li> </ul>	<div data-bbox="924 882 1174 943" style="border: 1px dashed black; padding: 2px;">MAJOR END USER</div> <div data-bbox="1217 882 1592 943" style="margin-left: 100px;">  </div> <ul style="list-style-type: none"> <li>▪ Removal of undesirable pollutants bypassing gases through a sorbent.</li> <li>▪ The most common sorbents are lime and limestone.</li> </ul>	<div data-bbox="1676 882 1944 943" style="border: 1px dashed black; padding: 2px;">MAJOR END USERS</div> <div data-bbox="1982 868 2390 968" style="margin-left: 100px;">  </div> <ul style="list-style-type: none"> <li>▪ A key component in glass manufacturing.</li> <li>▪ Main function is to introduce Calcium Oxide into glass to improve chemical resistance and durability.</li> </ul>

# Georgia Ag Lime Market

- In the heart of prime farmland, primarily used for production of peanuts and cotton for the domestic US market.
- These farms require significant volumes of agricultural lime additives to remain productive.
- The majority of this market is supplied by Florida based limestone and dolomite operations.

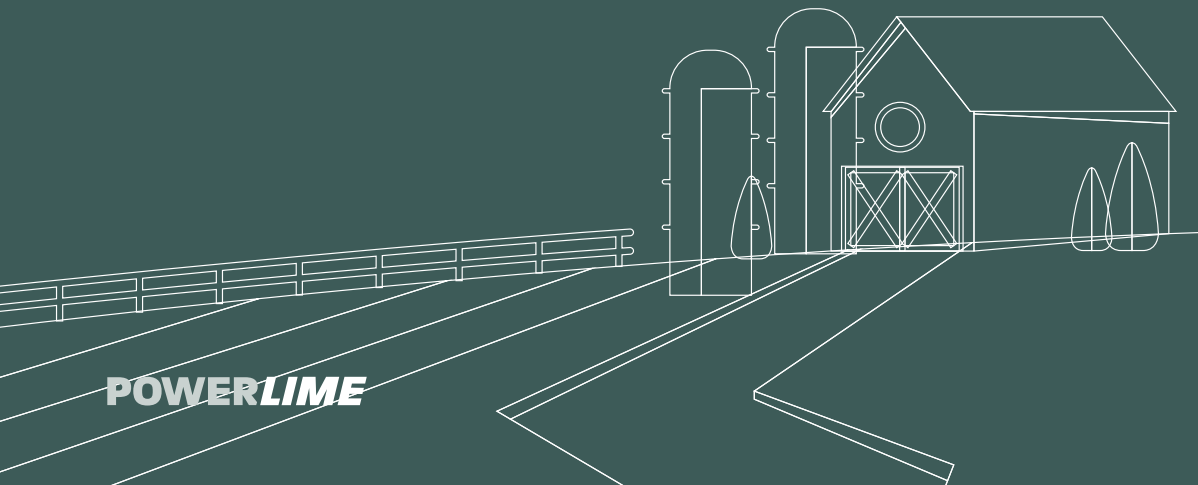

**POWERLIME**

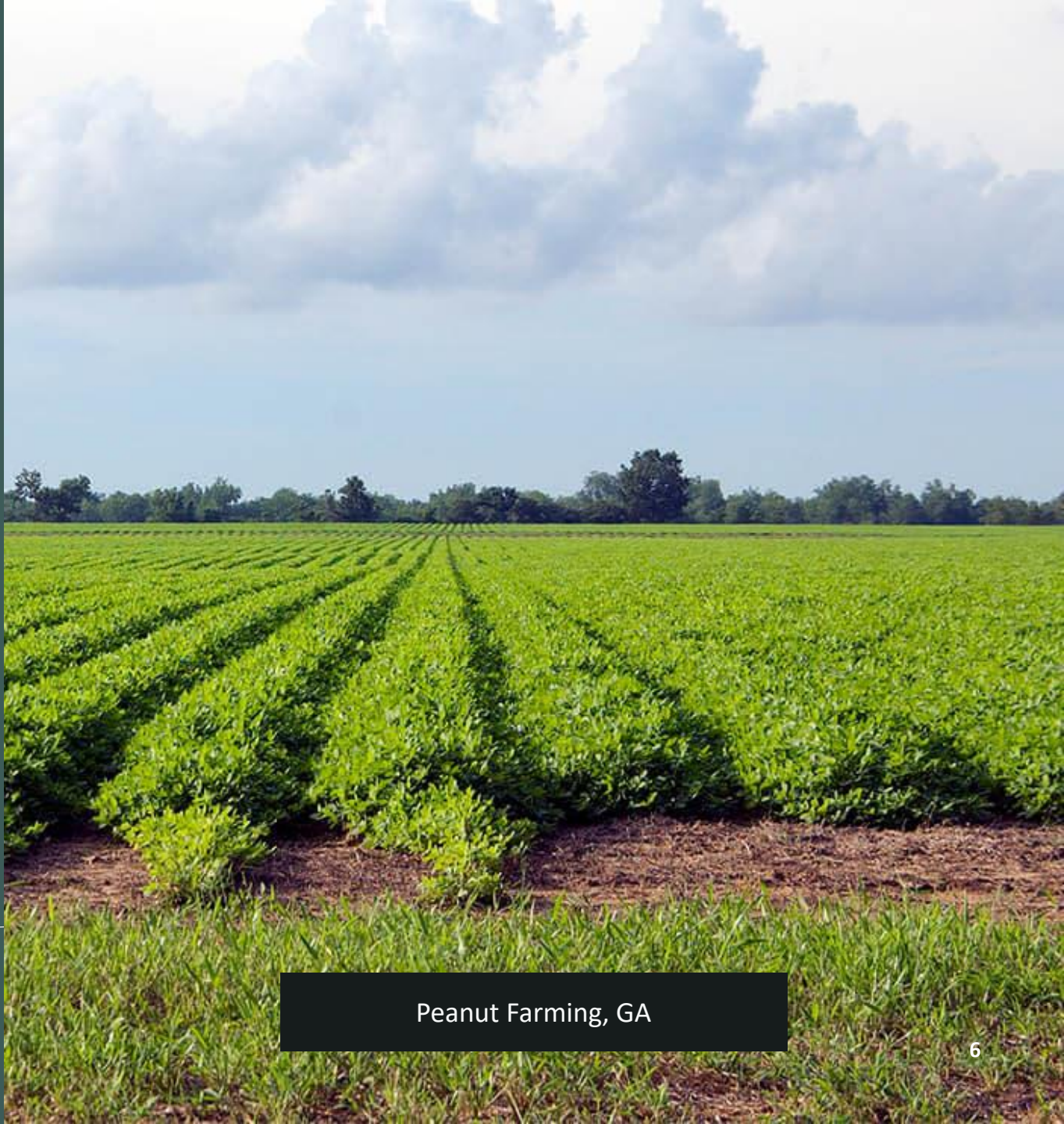

Peanut Farming, GA



# Geological Work

- 8 sonic holes drilled and 8 test pits dug in 2019 and 2020.
- Limestone intersections of up to 10m from near surface.
- Consistent, high calcium limestone in all samples, generally ~96% - 97% CaCO<sub>3</sub>.
- Potential to rapidly define a large high calcium limestone mineral resource on the property.
- Growth potential through future acquisition of mineral rights on adjacent properties.

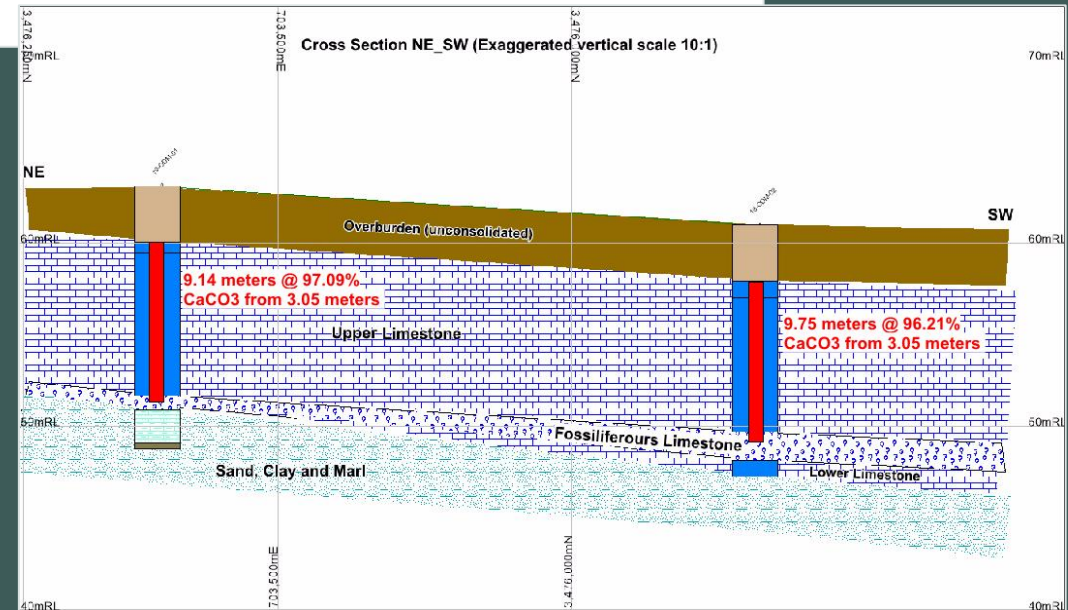
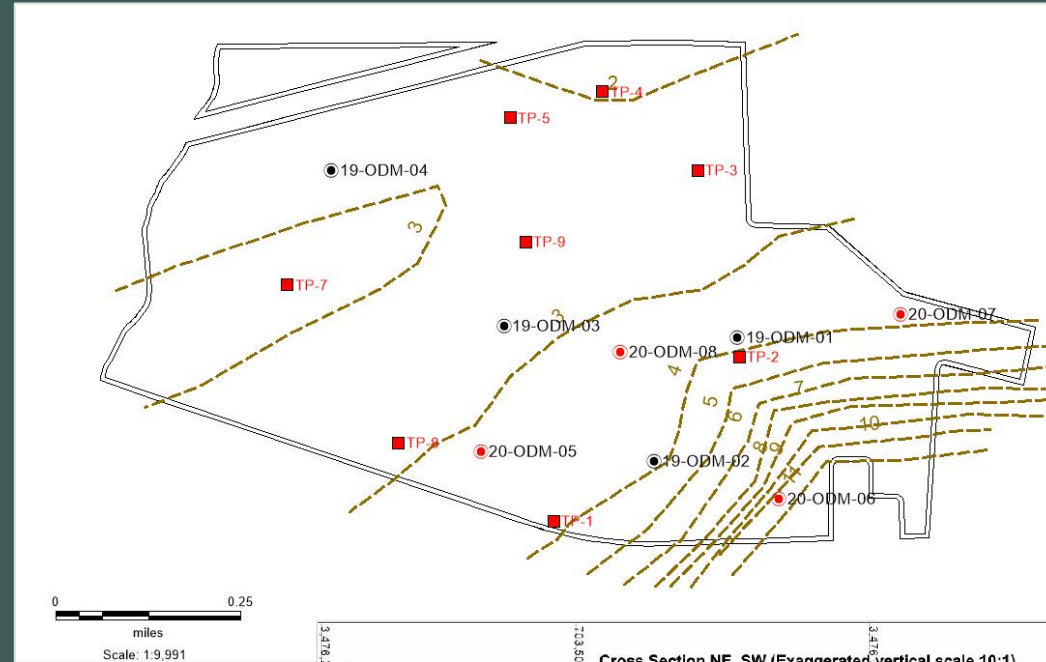

# Metallurgy & Chemical Test Work

- Geochemical analysis, abrasion testing and specific gravity analysis undertaken for the limestone
- Initial geochemical analysis suggest that the product may be suitable for all applicable markets
  - Ag Lime, Scrubber and Glass

	Hole ID	Limestone Thickness (m)	Ca	CaO	CaCO3	Mg	MgO	MgCO3	Fe2O3	Al2O3	Si	SiO2	S	K2O	Na2O	Mn	LOI	P2O5	MnO	Cr2O3
			%	%	%	%	%	%	%	%	%	%	%	%	%	%	%	%	%	%
2019 Drilling	20-ODM-01*	9.14	38.88	54.40	97.09	0.16	0.26	0.54	0.27	0.22	0.40	0.86	nd	0.03	<0.01	0.04	43.75	NA	NA	NA
	20-ODM-02*	9.75	38.53	53.91	96.21	0.16	0.27	0.56	0.44	0.25	0.79	1.70	nd	0.04	<0.01	0.04	43.33	NA	NA	NA
	20-ODM-03*	7.01	38.51	53.88	96.29	0.18	0.30	0.63	0.45	0.28	0.73	1.56	nd	0.06	<0.01	0.03	43.03	NA	NA	NA
	20-ODM-04*	3.51	38.37	53.69	96.10	0.19	0.31	0.65	0.41	0.39	0.72	1.54	nd	0.04	0.01	0.03	43.29	NA	NA	NA
2020 Drilling	20-ODM-05*	9.75	37.56	52.59	93.76	0.21	0.35	0.73	1.00	0.57	2.23	4.78	0.02	0.04	<0.005	0.01	40.38	NA	NA	NA
	20-ODM-06	9.75	39.36	55.08	98.30	0.16	0.26	0.55	0.34	0.30	0.52	1.11	0.02	nd	nd	nd	43.13	NA	NA	NA
	20-ODM-07	8.23	39.05	54.64	97.52	0.16	0.27	0.56	0.34	0.52	0.72	1.55	0.02	nd	nd	nd	42.67	NA	NA	NA
	20-ODM-08*	11.28	38.72	54.19	96.73	0.20	0.33	0.68	0.64	0.43	0.93	2.00	0.02	0.06	<0.005	0.02	42.38	NA	NA	NA
2020 Test Pits	TP-1	NA	39.02	54.60	97.45	0.13	0.22	NA	0.23	0.22	0.30	0.64	<0.01	0.02	<0.01	0.02	44	0.03	0.02	<0.01
	Blank	NA	27.23	38.10	68.00	6.69	11.10	NA	0.97	0.68	3.31	7.08	0.1	0.17	<0.01	0.05	41.5	0.07	0.06	<0.01
	TP-2	NA	38.95	54.50	97.27	0.15	0.25	NA	0.22	0.27	0.40	0.86	<0.01	0.02	<0.01	0.02	43.7	0.03	0.03	<0.01
	TP-3	NA	39.17	54.80	97.81	0.11	0.19	NA	0.20	0.20	0.26	0.56	<0.01	0.02	<0.01	0.02	43.8	0.03	0.03	<0.01
	TP-4	NA	38.38	53.70	95.84	0.12	0.20	NA	0.41	0.21	0.29	0.62	<0.01	0.02	<0.01	0.03	43.8	0.09	0.04	<0.01
	TP-5	NA	39.02	54.60	97.45	0.15	0.25	NA	0.20	0.15	0.22	0.48	<0.01	0.02	<0.01	0.03	43.9	0.03	0.04	<0.01
	TP-7	NA	39.17	54.80	97.81	0.13	0.22	NA	0.18	0.17	0.28	0.60	<0.01	0.02	<0.01	0.03	44	0.03	0.04	<0.01
	TP-8	NA	39.09	54.70	97.63	0.16	0.26	NA	0.17	0.25	0.36	0.77	<0.01	0.02	<0.01	0.03	43.9	0.04	0.04	<0.01
	TP-9	NA	38.88	54.40	97.09	0.14	0.23	NA	0.20	0.23	0.34	0.73	<0.01	0.02	<0.01	0.02	43.9	0.04	0.03	<0.01

# Process Design & Cost Estimate

- Marshall Miller & Associates were engaged to perform a high level cost analysis for a starter operation.
- The analysis was focused upon investigating the development of an initial small scale, positive cashflow operation.
- The analysis highlighted the potential for a low cost lime operation in the region.

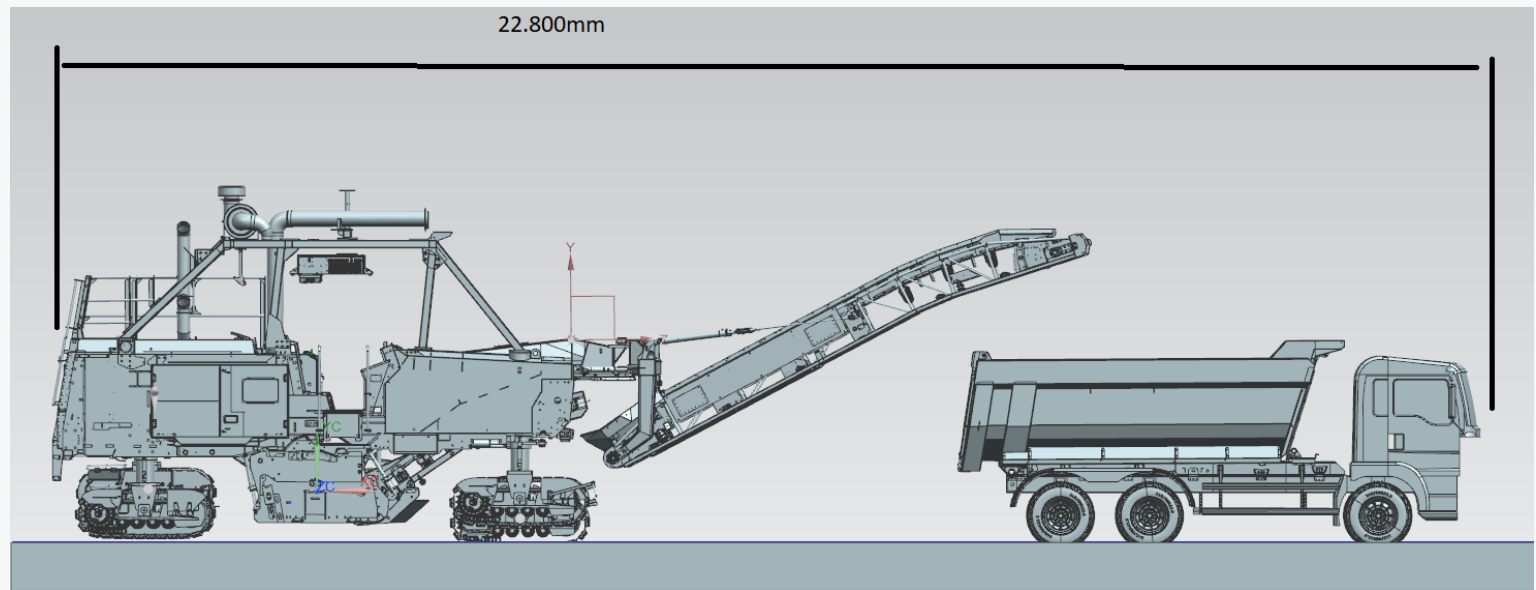

# Downstream Potential

- The property is located close to rail, power, natural gas and labour.
- Given the pro-development stance of the government, there is the potential to permit and operate a new, large, SE US based lime kiln for production of quick and/or hydrated lime.
- The development of a lime operation in this location would become the closest lime kiln to the large markets of Florida and southern Georgia.

## THE LIME CYCLE

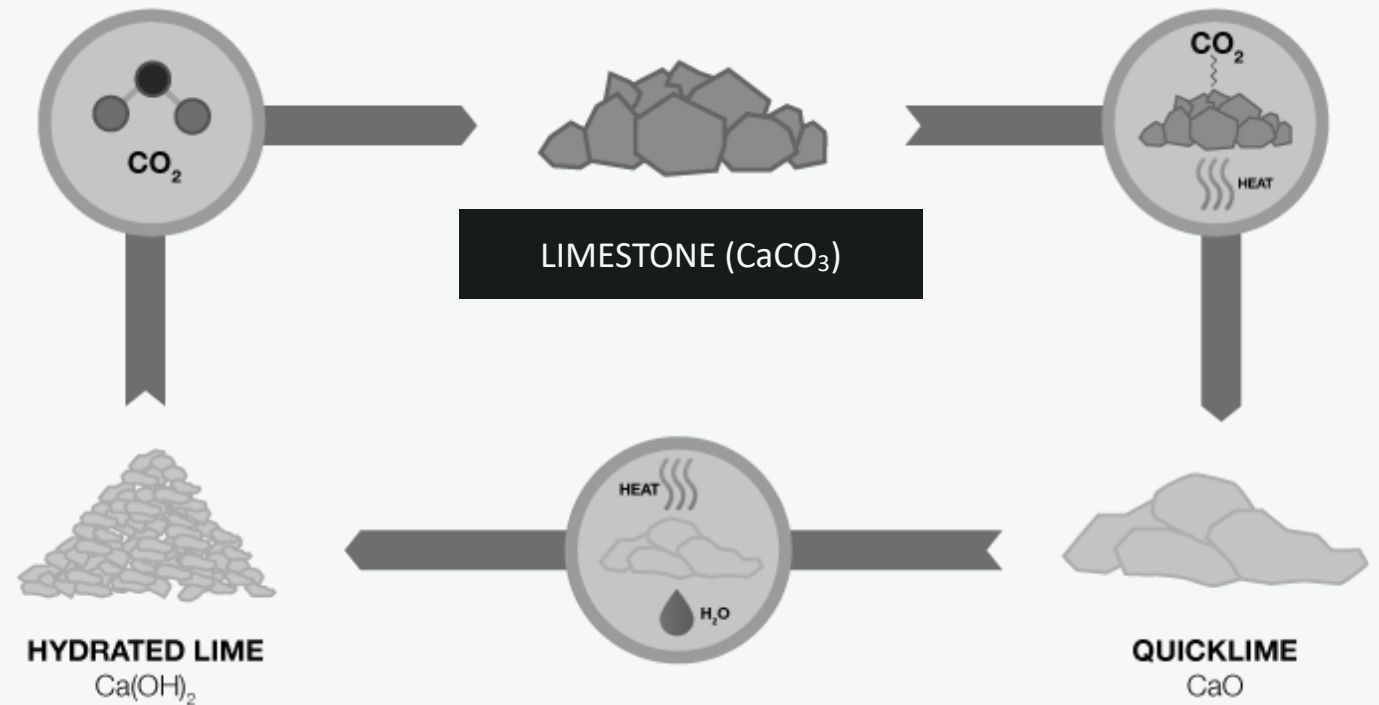

HYDRATED LIME	QUICKLIME
<ul style="list-style-type: none"> <li>▪ Used in a variety of industrial applications including water treatment, as an anti-stripping agent in asphalt, and in soil stabilization.</li> </ul>	<ul style="list-style-type: none"> <li>▪ Used in various metallurgical, industrial, chemical and agricultural applications.</li> </ul>

# Founders & Track Record

## **Anastasios Arima**

Founder & Director of ASX / Nasdaq-listed Piedmont lithium Ltd and Managing Director of ASX-listed Hyperion Metals.

## **Lamont Leatherman**

Founder and Chief Geologist of ASX / Nasdaq-listed Piedmont Lithium Ltd. 25+ years experience in U.S. exploration, including senior positions with BHP.

## **Patrick Brindle**

Civil engineer with over 20 years of experience in the development of U.S. and global mining operations and industrial projects. Vice President – Project Management for ASX / Nasdaq-listed Piedmont Lithium.

## **Dominic Allen**

15 years experience in the financing, development and operations of natural resource organizations, including with Rio Tinto Limited and Oyu Tolgoi LLC. Head of Corporate Development for ASX-listed Hyperion Metals.

## **Landon Woodall**

Geologist with deep experience in U.S. mineral exploration and operations, particularly in Georgia, performing advanced field methodology and report development activities.

