

Magnetic separation increases TREE grade by 216% and Scandium by 90% with ore mass reduced by 76% for Surface Samples at La Paz

La Paz Rare Earths Project Ore Effectively Concentrated Using Magnetic Separation and Direct Flotation

Highlights

- **Magnetic separation produced a concentrate with 1744 ppm for Total Rare Earth Elements (TREEs) and 30 ppm for Scandium (Sc) with 74.7% and 43.8% recovery respectively, rejecting 76% of the ore mass**
- **Increasing Grade and Reducing ore mass is a very promising economic outcome**
- **TREE concentrated from 552ppm to 1744ppm (+216%) recovering 74.7% of available TREE**
- **Scandium concentrated from 16ppm to 30.4ppm (+90%) recovering 43.8% of available Scandium**
- **Concentrating and reducing the ore mass significantly reduces downstream metallurgy costs**
- **Rejected ore mass may be returned to the open pit, simplifying ESG and reclamation**
- **Advanced metallurgy work program commenced at Nagrom Ltd in Western Australia**
 - **Utilising core selected from the 2021 diamond core drilling program**
 - **Goal of significantly improving on these preliminary results and**
 - **Developing an advanced mineral processing and metallurgy flow sheet**

American Rare Earths Limited (ASX:ARR) ("the Company") is pleased to announce the results of TREE concentration testing of surface samples from the La Paz Rare Earths project (La Paz REE) in Arizona. This preliminary test work demonstrates that ore from La Paz can be effectively concentrated using magnetic separation, selective grinding and direct RE flotation. The results show that plant feed material (pulverised ore) could be reduced by 76.3% while recovering 74.7% of the available TREE and 43.8% of the available Scandium. TREE grades were concentrated from 552ppm to 1744ppm an increase of 216%. Scandium grades were concentrated from 16 ppm to 30.4 ppm an increase of 90%.

This announcement supports the development of the US domestic rare earths supply chain, highlights the strategic value of our assets to the US Government, and potentially shortens the US supply chain for critical minerals including rare earth elements. (Executive Order on America's supply chains February 24, 2021, Presidential Actions). Rare earths are critical metals to the US and are essential to manufacturing strategic products including electric motors, airplanes, and defence equipment

Mr. Keith Middleton, Managing Director of ARR adds, "ARR is extremely pleased with the preliminary test results at La Paz. These results demonstrate that ore material from La Paz can be effectively concentrated using proven technologies. Reducing ore material by 76% while recovering nearly 75% of TREE, with a 216% increase in TREE grade, is an important step in the technical evaluation of La Paz, where we plan to deliver, low-cost rare earth elements, for the US domestic and military supply chain."

American Rare Earths Limited (ASX:ARR)

Capital Structure: Ordinary Shares on Issue 344,308,326

American Rare Earths Limited ARBN 003 453 503

Head Office: Suite 706 Level 7, 89 York St, Sydney NSW 2000 Tel +61 2 8054 9779

GPO BOX 1546, Sydney NSW 2001

Email info@americanrareearths.com.au

Web: <https://americanrareearths.com.au/>

Surface Sample Concentration Project Summary

Saskatchewan Research Council (SRC) performed a series of magnetic separation tests and liquid flotation tests on surface rock samples collected in the La Paz resource area. The objective of the test work was to determine if REE elements can be concentrated from ore rock using magnetic and/or liquid flotation as a means of pre-processing material used for later refining. ARR provided approximately 72 kilograms of material from 32 rock samples collected in early 2021 across the La Paz resource area, see Figure 1, Location of Test Work Samples below.

SRC prepared a 5kg composite sample from the 32 rock samples and crushed to 100% passing No. 100 mesh (<150 microns). SRC analysed a head sample for TREE and Sc. The TREE content of the sub-sample is 552 ppm (TREEO 662ppm), the Sc grade is 15 ppm (Sc₂O₃ 25ppm). SRC performed X-Ray Diffraction (XRD) to determine the mineral components of the source rocks, see Table 1.

Table 1 - Mineral Results of XRD Analysis

	Analysis Mineral Phases	Source	Wt. %
Albite	(AlSi ₃)NaO ₈	PDF#98-090-0656	32.5
Quartz	SiO ₂	PDF#98-091-4776	27.0
Biotite	FeMg ₂ K (AlSi ₃) O ₁₂ H ₂	PDF#98-090-2555	13.8
Anorthite	CaSi AlO ₄	PDF#98-090-0971	10.8
Clinozoisite	Ca ₂ Si ₃ Al _{2.79} Fe _{0.21} O ₁₃ H	PDF#98-090-4272	9.0
Chamosite	(Mg _{2.518} Fe _{2.482}) Al _{1.2} Si _{3.8} O ₁₈ H ₁₀	PDF#98-090-3835	7.0

Reducing mass of feed material (pulverised ore), concentrating the mineralised material (ore), could significantly reduce operational expenses during processing. Such cost savings would be a function of having less material (processed ore) to be leached. Less material to be leached could reduce cost of leaching chemicals and reduce the volume of tailings. The gangue material removed by magnetic separation would be void of any chemical treatment. This clean, pulverised gangue material would likely be safe to return to the void of an open pit mine during mine reclamation. The Company believes that a project with less volume of chemically treated tailings and a more simple, cost-effective reclamation process has a better opportunity for permit approvals compared to not having these advantages. This responsible mining approach is consistent with the Company's Environmental, Social and Governance (ESG) values.

The success of this preliminary work led to the Company following the recommendations of its technical team and the experts at AMEC Foster Wheeler Pty Ltd (trading as Wood). Thus, an advanced metallurgy and mineral processing work program has commenced at Nagrom Ltd in Western Australia. The company believes this "teamed experts" approach will maximise the opportunity to successfully advance this important work.

The advance work program began in August 2021 and will utilise core selected from the resource area of the 2021 diamond core drilling program at the La Paz project.

This program has the key goals of

- 1) Significantly improving on the preliminary results (described in this report),
- 2) Developing an advanced mineral processing and metallurgy flow sheet that ultimately produces
- 3) A pre-leaching concentrate of 5,000 ppm (or greater), Total Rare Earth Elements (TREE) along with a concomitant upgrade of the Scandium (Sc).

Technical Summary

The results of this test work have been compiled in accordance with the 2012 edition of The Australian Code for Reporting of Exploration Results, Mineral Resources and Ore Reserves (JORC Code 2012). An updated JORC Table 1 referencing these results for La Paz resides in **Appendix A** below.

ARR employed Wood to review a report prepared by SRC and to summarize the results. The Wood report, entitled "Review of 2021 SRC Testwork Program Results", resides in **Appendix B** below. SRC prepared a detailed summary report, entitled "Concentration of TREE from Surface Chip Samples", June 2021 (SRC Report). The SRC report is included in the Wood report.

Stage 1 of the project consisted of performing sighter magnetic separation testing on composite samples. Stage 2 consisted of sighter flotation testing on WHIMS concentrate prepared from composite samples.

SRC prepared a 5kg composite sample from the 32 rock samples and crushed to 100% passing No. 100 mesh (<150 microns). SRC analysed a head sample for TREE and Sc. The TREE content of the sub-sample is 552 ppm (TREEO 662ppm), the Sc grade is 15 ppm (Sc_2O_3 25ppm). SRC performed X-Ray Diffraction (XRD) to determine the mineral components of the source rocks, see Table 1.

Figure 1 - Location of Test Work Samples

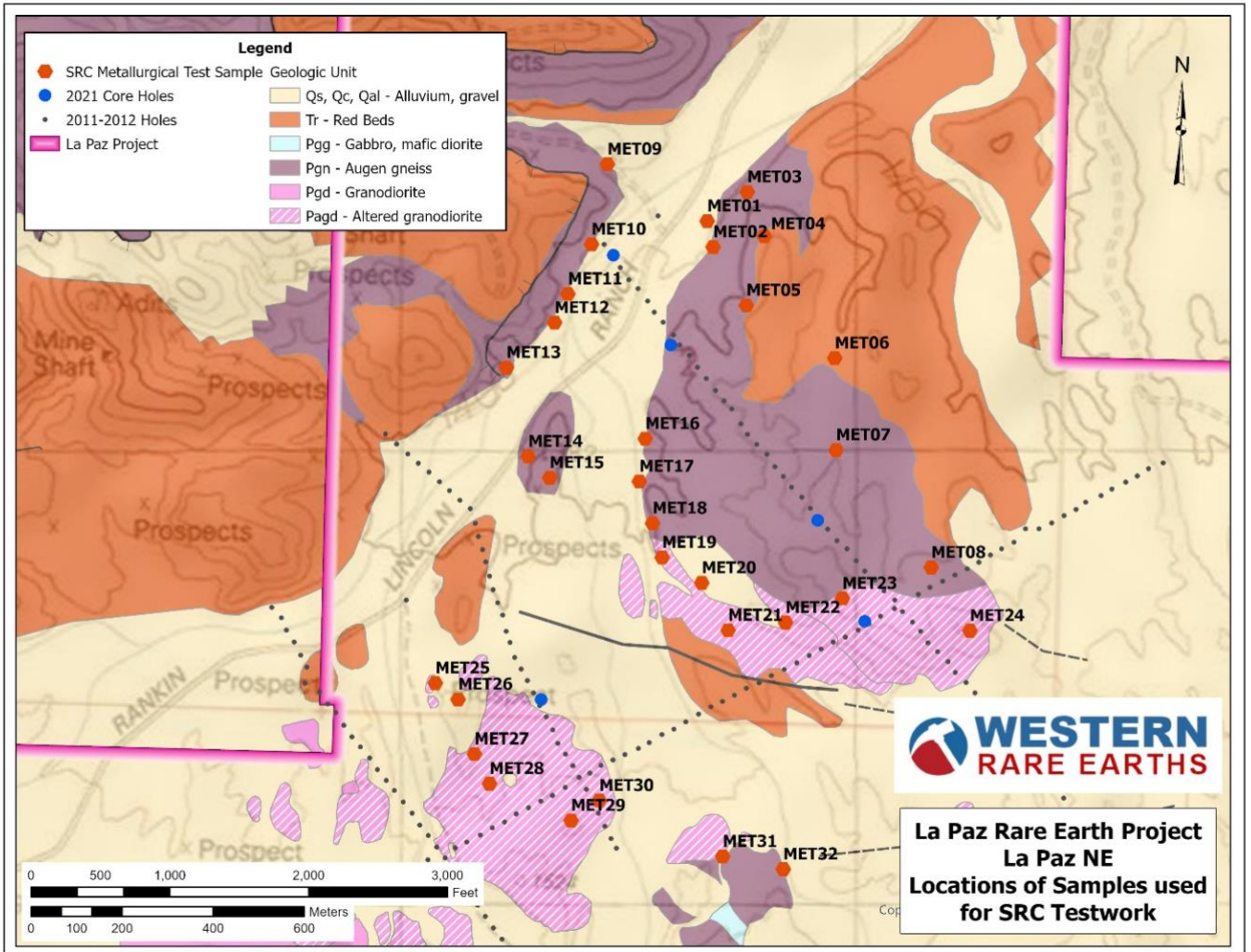

Stage 1 Sighter Test Work

Dry Magnetic Separation

SRC performed dry magnetic separation using a Frantz Separator for four (4) different size fractions, see Table 2. TREE recovery is relatively stable across the sizes tested, dropping for the finest size fraction. The dry separation demonstrates that TREE grade increases with finer size fractions indicating the ore benefits from finer grinding to liberate rare earth minerals, primarily allanite.

Table 1 - Dry Separation by Size Fraction

Size Fraction microns	Yield			Grade			
	Mass %	Fe2O3 %	TREE %	LREE ppm	HREE ppm	TREE ppm	Fe2O3 wt%
106-150	35.4	90.6	82.4	367	74	441	7.1
75-106	17.0	94.6	87.2	688	72	760	8.2
38-75	30.0	88.8	83.0	1020	182	1202	10.5
25-38	17.6	84.5	79.6	1065	192	1257	11.3
Cumulative Total	100.0	89.7	82.9	740	127	867	9.0

Sighter Wet Magnetic Separation

SRC performed wet low intensity magnetic separation (LIMS) on a 1.8kg composite sample, from Stage 1, milled to 80% passing 75 microns at 1000 gauss to remove magnetite and other diamagnetic minerals. The sample was then processed by wet high intensity magnetic separation (WHIMS) at 10,000 gauss (1 Tesla) for a rougher magnetic separation. The concentrate was then reground to 80% passing 38 microns and subjected to cleaner WHIMS processing. Table 3 summarises the results of the wet separation processing tests.

Table 2 - Wet Separation Results

Separation Process	Yield	TREE		Scandium	
	Mass %	ppm	%Recovered	ppm	%Recovered
Feed	100	552	100.0	16	100.0
LIMS mags	4.0	912	6.6	22	5.5
Rougher WHIMS mags	19.6	1914	68.1	31	38.3
Cleaner WHIMS mags	6.3	2560	29.3	42	16.6
LIMS+Cleaner WHIMS mags	10.3	1921	36.0	34	22.1
LIMS+Rougher WHIMS mags	23.7	1744	74.7	30	43.8

LIMS+Rougher WHIMS processing returned the highest mass yield of 23.7% with an increase in TREE grade to 1744ppm (TREO 2094ppm) while capturing 74.7% of all TREE. An increase in Scandium grade from 16ppm to 30ppm (Sc₂O₃ 47ppm) while capturing 43.8% of Scandium.

Wood stated of these results “Preliminary work conducted in this study produced a concentrate with 1744 ppm TREEs and 30 ppm Sc for 74.7% and 43.8% recovery respectively, rejecting 76% of feed mass, a very promising outcome”

Rougher WHIMS processing returned good grade increases of TREE to 1914ppm (TREO 2298ppm) and an increase in Scandium grade to 31ppm (Sc₂O₃ 48ppm) with a mass yield of 19.6%.

Scavenger processing of WHIMS tails material undertaken to determine if additional TREE and Sc could be recovered from the tails. Scavenging of cleaner WHIMS tailings material saw an increase in lost TREE grade from 1547ppm to 1789ppm (TREO 2148ppm) while capturing an additional 31.2% TREE at a mass yield of 27%. Scavenging of cleaner WHIMS tailings material saw an increase in lost Scandium grade 23ppm to 38ppm (Sc₂O₃ 58ppm) while capturing an additional 43.8% Scandium, see Table 4.

Table 3 - Cleaner-Scavenger WHIMS Results

Stage Performance	Yield	TREE		Scandium	
	Mass %	ppm	%Recovered	ppm	%Recovered
Cleaner scavenger mags	27	1789	31.2	38.0	43.8
Clean scavenger non-mags	73	1457	68.8	18.0	56.2
Feed (Cleaner WHIMS non-mag)	100	1547	100.0	23.4	100.0

Stage 2 Flotation Test Work

SRC performed flotation for eight different liquid media using a specially prepared concentrate sample of the La Paz rock samples. The composite sample was crushed to -2mm and milled to 80% passing through 75-micron mesh followed by rougher WHIMS processing at 10,000 gauss (1 Tesla). The resulting feed grade for the flotation test work was TREE 1279ppm (TREEO 1535 ppm).

Table 5 summarises the results of the eight flotation tests. **The collector agents Oleic Acid and Aero 845 showed significant increase in grade with high TREE recoveries. Oleic acid shows an effective grade increase of 571 ppm (57%) with a TREE recovery of 70.6%. Aero 845 shows an effective grade increase of 229 ppm (21%) with a TREE recovery of 86.8%.**

Table 4 - Summary of Flotation Test Results

Test	Collector	Product	Cum. Float Time (min)	Product Mass Yield (%)	Calc Feed TREE Grade (ppm)	Product TREE Grade (ppm)	Product TREE Recovery (%)
F1	Armac T	Sinks	7	81.2	1413	1490	85.6
F2	Flotigam EDA	Sinks	5	42.2	1260	1398	46.8
F3	Flotigam 4343	Sinks	5	78.6	1209	1208	78.5
F4	Aero 3030	Sinks	4	48.1	1098	1163	49.1
F5	Flotigam EDA	Sinks	9	40.3	1070	1580	34.0
F6	Oleic acid	Floats	7	54.9	1005	1576	70.6
F7	Aero 845	Floats	6	71.5	1066	1295	86.8
F8	Aero 6493	Floats	6	47.4	1039	1491	68.1

This market announcement has been authorised for release to the market by the Board of American Rare Earths Limited.

Keith Middleton
Managing Director

This ASX announcement refers to information extracted from market announcements available on ARR's website <https://americanrareearths.com.au>. ARR confirms it is not aware of any new information or data that materially affects the information included in the original market announcements. In the case of Mineral Resources estimates, all material assumptions and technical parameters underpinning the estimates in the relevant market announcements continue to apply and have not materially changed. ARR confirms that the form and context in which the Person's findings presented have not been materially modified from the original market announcements.

Competent Persons Statement: The information in this document that relates to Concentration of TREE in surface samples is based on information compiled by Mr. Greg Henderson. Mr. Henderson is Process Consultant at Wood plc. Mr. Henderson is a Fellow of the Australian Institute of Mining and Metallurgy (AUSIMM), number 109007, and has sufficient experience which is relevant to the style of mineralisation and type of deposit under consideration and to the activity which he is undertaking to qualify as a Competent Person as defined in the 2012 JORC Code. Mr. Henderson consents to the inclusion in the report of the matters based upon the information in the form and context in which it appears.

Competent Persons Statement: The information in this Report related to Exploration Results is based on the information compiled by Mr Jim Guilinger. Mr Guilinger is a Member of a Recognised Overseas Professional Organisation included in a list promulgated by the ASX (SME Registered Member of the Society of Mining, Metallurgy and Exploration Inc). Mr Guilinger is Principal of independent consultants World Industrial Minerals LLC. Mr Guilinger has sufficient experience relevant to the style of mineralisation and type of deposit under consideration. The activity they are undertaking as a Competent Person as defined in the 2012 Edition of the 'Australasian Code for Reporting of Exploration Results, Mineral Resources and Ore Reserves'. Mr Guilinger consents the matters in the Report are based on the information in the form and context in which it appears.

About American Rare Earths

American Rare Earths Limited (ASX: ARR) is the only Australian company listed on the ASX with assets in the growing rare earth metals sector of the United States of America, itself emerging as an alternative international supply chain to China's market dominance of a global rare earth market expected to balloon to US\$20 billion by the mid-2020s. ARR owns 100% of the world-class La Paz rare earth project, located 170km northwest of Phoenix, Arizona. As a large tonnage, bulk deposit, La Paz is also potentially the largest, rare-earth deposit in the USA and benefits from containing exceptionally low penalty elements such as radioactive thorium and uranium. ARR plans to deliver its first Preliminary Economic Assessment for La Paz by 2022 and is working with leading USA research institutions La Paz's mineral profile incorporated into emerging US advanced rare earth processing technologies. ARR acquired a second USA REE asset in the Searchlight Rare Earths project in the first half of 2021. ARR has also acquired a third USA REE asset, the Halleck Creek project in Wyoming, in June 2021.

Appendix A

JORC Code, 2012 Edition – Table 1 La Paz Rare Earth Project		
Section 1 Sampling Techniques and Data		
(Criteria in this section apply to all succeeding sections.)		
Criteria	JORC Code explanation	Commentary
<i>Sampling techniques</i>	<i>Nature and quality of sampling (e.g. cut channels, random chips, or specific specialised industry standard measurement tools appropriate to the minerals under investigation, such as downhole gamma sondes, handheld XRF instruments, etc.). These examples should not be taken as limiting the broad meaning of sampling.</i>	Historical drilling: In 2011, the prospect was drill tested by 195 percussion drill holes ranging from 40' (13m) to 100' (30m depth) for a total of 18,805' (5,731)m. Drilling was completed on three parallel section lines across strike and 1 section line along strike, with holes spaced 100' along section lines.
		March 2021 Core Drilling: WRE drilled nine diamond core holes of HQ size ranging from 168 feet to 403 feet in depth with a total length of 2,238 feet (682 meters), 6 Holes core were twins of select percussion holes drilled in 2011.
	<i>Include reference to measures taken to ensure sample representivity and the appropriate calibration of any measurement tools or systems used.</i>	Representative 1kg samples were collected from each 5' (1.52m) interval of drilling
	<i>Aspects of the determination of mineralisation that are Material to the Public Report.</i>	
	<i>In cases where 'industry standard' work has been done, this would be relatively simple (e.g. 'reverse circulation drilling was used to obtain 1 m samples from which 3 kg was pulverised to produce a 30 g charge for fire assay'). In other cases, more explanation may be required, such as where there is coarse gold that has inherent sampling problems. Unusual commodities or mineralisation types (e.g., submarine nodules) may warrant disclosure of detailed information.</i>	A 250g sub-sample was pulverised to -75 microns and a 0.5g charge was assayed for REEO by ICP-MS using standard industry procedures at ALS Chemex, Reno, Nevada.

Drilling techniques	<i>Drill type (e.g. core, reverse circulation, open-hole hammer, rotary air blast, auger, Bangka, sonic, etc.) and details (e.g. core diameter, triple or standard tube, depth of diamond tails, face-sampling bit or another type, whether the core is oriented and if so, by what method, etc.).</i>	Historical drilling: A track-mounted percussion rig supplied by Dynamic Rock Solutions LLC, Salome, Arizona, was used to drill 195 3.5" diameter percussion holes. Drilling began on April 20th, 2011 and was completed on May 31st 2011. Hole depths varied from 40-100', with 142 out of 195 holes drilled to 100' depth. A total of 18,805' (5,731m) was drilled.
		March 2021 Core Drilling: Timberline Drilling, Inc. from Elko, Nevada, used a track-mounted core rig to drill HQ diameter core holes. Six holes were in the La Paz Resource area and three additional holes were drilled on the remainder of the property. See the Drill Hole Location Map. Drilling commenced on 11 March 2021 and concluded on 31 March 2021. Drill hole depths varied between 168 feet and 403 feet for a total length of 2,238 feet (682 meters).
Drill sample recovery	<i>Method of recording and assessing core and chip sample recoveries and results assessed.</i>	A sampling of ~200g per foot drilled to produce a composite~1kg sample for every 5' drill interval which is considered representative of each interval.
		March 2021 Core Drilling: Core recovery was 98% ±. The core material was sent to America Assay Labs in Spark, Nevada for assay.
		All drilling was carried out above the water table to minimize possible contamination
	<i>Measures are taken to maximise sample recovery and ensure the representative nature of the samples.</i>	
	<i>Whether a relationship exists between sample recovery and grade and whether sample bias may have occurred due to preferential loss/gain of fine/coarse material.</i>	
Logging	<i>Whether core and chip samples have been geologically and geotechnically logged to a level of detail to support appropriate Mineral Resource estimation, mining studies and metallurgical studies.</i>	A representative sample of each 5' interval was retained in chip trays for logging. Geological logging is considered to have been logged to a level of detail appropriate to support Mineral Resource Estimates.
		Chip sample logging is qualitative in nature
	<i>Whether logging is qualitative or quantitative in nature. Core (or costean, channel, etc.) photography.</i>	
	<i>The total length and percentage of the relevant intersections logged.</i>	Drill holes were logged in full based on representative samples from every 5' interval.
		March 2021 Core Drilling: All Core was logged and photographed on-site by qualified geologists.

<p><i>Sub-sampling techniques and sample preparation</i></p>	<p><i>If core, whether cut or sawn and whether quarter, half or all core taken.</i></p>	<p>No core samples were collected in the 2011 drilling.</p>
		<p>March 2021 Core Drilling: All Core was shipped to American Assay Labs for further logging and testing. Additional samples were selected for metallurgical testing.</p>
	<p><i>If non-core, whether riffled, tube sampled, rotary split, etc. and whether sampled wet or dry.</i></p>	<p>Percussion chips were collected in a bucket for every 5' interval. The site geologist prepared a representative 1kg sample from each 5' interval.</p>
	<p><i>For all sample types, the nature, quality and appropriateness of the sample preparation technique.</i></p>	<p>All samples were dry. Sample preparation: 1kg samples split to 250g for pulverising to -75 microns. Sample analysis: 0.5g charge assayed by ICP-MS technique</p>
	<p><i>Quality control procedures adopted for all sub-sampling stages to maximise the representivity of samples.</i></p>	<p>The 1kg samples were delivered to an accredited laboratory for sample preparation and analysis</p>
	<p><i>Measures are taken to ensure that the sampling is representative of the in-situ material collected, including, for instance, results for field duplicate/second-half sampling.</i></p>	<p>Sample preparation techniques are considered industry practice and are conducted at the accredited external laboratory; all deemed appropriate to the style of mineralization and suitable for determining Mineral Resource Estimates</p> <p>March 2021 Core Drilling: After logging, photographing, samples were boxed and securely banded for shipping to American Assay Labs. The lab performed assays, additional photography and cutting in preparation for studies and mineral processing and metallurgy. Chans of custody were always maintained.</p>
<p><i>Whether sample sizes are appropriate to the grain size of the material being sampled.</i></p>		
<p><i>Quality of assay data and laboratory tests</i></p>	<p><i>The nature, quality and appropriateness of the assaying and laboratory procedures used and whether the technique is considered partial or total.</i></p>	<p>Sample analysis: A 250g split from each sample was pulverised to - 75 micron and a 0.5g subsample fused with lithium borate, then subjected to a 4-acid digest and then assayed by ICP-MS for 38 elements.</p>

	<i>For geophysical tools, spectrometers, handheld XRF instruments, etc., the parameters used in determining the analysis including instrument make and model, reading times, calibrations factors applied and their derivation, etc.</i>	No geophysical tools, spectrometers, handheld XRF instruments, etc were used.
	<i>Nature of quality control procedures adopted (e.g., standards, blanks, duplicates, external laboratory checks) and whether acceptable levels of accuracy (i.e. lack of bias) and precision have been established.</i>	The laboratory used standard quality control procedures incorporating duplicate samples, standards, and blanks.
<i>Verification of sampling and assaying</i>	<i>The verification of significant intersections by either independent or alternative company personnel.</i>	An independent consultant geologist verified significant intercepts as part of the resource estimation.
	<i>The use of twinned holes.</i>	No twinned holes were used.
	<i>Documentation of primary data, data entry procedures, data verification, data storage (physical and electronic) protocols.</i>	Initially, all chip trays for each hole interval were stored in a secure facility in Bouse, Arizona. All drill hole logs, associated interval assay results were stored electronically within the company. All geologic data was entered onto log sheets manually then subsequently entered into the computer. Data always was secure WRE collected QAQC samples during sample preparation. WRE is in the process of statistically analysing the sample QAQC sample results.
	<i>Discuss any adjustment to assay data.</i>	None
<i>Location of data points</i>	<i>Accuracy and quality of surveys used to locate drill holes (collar and down-hole surveys), trenches, mine workings and other locations used in Mineral Resource estimation.</i>	Downhole surveyed were not used due to the short length (max 30m depth). Hole collars were surveyed using a handheld GPS.
		March 2021 Core Drilling: Locations were determined using Handheld GPS units. Downhole surveys were not performed due to relatively shallow depths.
	<i>Specification of the grid system used.</i>	Historic 2011 Drilling: UTM grid system NAD 1927 Zone 12 March 2021 Core Drilling: UTM grid system NAD 1983 Zone 12. (The entire project was updated to use NAD 1983 UTM Zone 12 projections.
	<i>Quality and adequacy of topographic control.</i>	Drill hole elevations were estimated using existing USGS topographic base maps as control.

<i>Data spacing and distribution</i>	<i>Data spacing for reporting of Exploration Results.</i>	
	<i>Whether the data spacing, and distribution is sufficient to establish the degree of geological and grade continuity appropriate for the Mineral Resource and Ore Reserve estimation procedure(s) and classifications applied.</i>	The data spacing and distribution are considered sufficient for the current level of early exploration of the areas of interest
	<i>Whether sample compositing has been applied.</i>	Samples have not been composited as all sample intervals were equal (5').
<i>Orientation of data in relation to geological structure</i>	<i>Whether the orientation of sampling achieves unbiased sampling of possible structures and the extent to which this is known, considering the deposit type.</i>	Close-spaced vertical drill holes were used to overcome any structural bias of the fine-grained disseminated REEO mineralisation.
		March 2021 Core Drilling: New diamond core from 6 twinned holes completed in the resource area to confirm the reserve and acquire a detailed geological understanding of the mineralized zones. See Drill Hole Location Map.
		March 2021 Core Drilling: Three exploration core holes were drilled in the southwest portion of the claim area to follow up on surface samples and to explore additional mineralized zones at depth. See Drill Hole Location Map.
	<i>If the relationship between the drilling orientation and the orientation of key mineralised structures is considered to have introduced a sampling bias, this should be assessed and reported if material.</i>	
<i>Sample security</i>	<i>The measures are taken to ensure sample security.</i>	Drill samples were kept in a secure storage locker before dispatch by bonded courier to the laboratory.
		March 2021 Core Drilling: All Core was collected from the drill rig daily and stored in a secure, locked facility until bonded courier dispatched the core to America Assay Labs. Chains of custody were always maintained.

<i>Audits or reviews</i>	<i>The results of any audits or reviews of sampling techniques and data.</i>	No audits or reviews have been conducted. An extensive review of the data has been undertaken to update the historical and current planned exploration activity.
Section 2 Reporting of Exploration Results		
(Criteria listed in the preceding section also apply to this section.)		
Criteria	JORC Code explanation	Commentary
<i>Mineral tenement and land tenure status</i>	<i>Type, reference name/number, location and ownership, including agreements or material issues with third parties such as joint ventures, partnerships, overriding royalties, native title interests, historical sites, wilderness or national park and environmental settings.</i>	<p>The tenement schedule is included in the appendix of this report. The tenements are in the form of 20-acre United States Bureau of Land Management lode mining claims. The total land package controlled by the Company in the La Paz Project Area consists of 261 unpatented lode mining claims totalling 5392.26 acres (2178.47 has). The State Exploration Permit totals 640 acres (259 has). The mining claims are 100% owned by the Company with no royalties. All claims are outside of any wilderness or national park and environmental settings. A historic railroad line crosses a portion of the claims outside of any historical or planned exploration programs. The State leased land is subject to a State royalty (yet undetermined) once the exploration activity has advanced to the exploitation level. At this point, the State engineers and geologists will evaluation any defined mineral deposit and determine an appropriate royalty.</p> <p>The QP is unaware of any environmental liabilities attached to the La Paz claims and is not a Qualified Person to environmental issues. An archaeological survey of the La Paz claims conducted by Professional Archaeological Services of Tucson, Arizona, dated March 20, 2011, was submitted to the Arizona State Land Department. The survey found no substantial areas of archaeological significance (P.A.S.T., 2011). The author is not a Qualified Person to archaeological issues.</p>
	<i>The security of the tenure held at the time of reporting and any known impediments to obtaining a licence to operate in the area.</i>	As long as annual Arizona State lease holding fees and annual claim holding fees are paid to both the BLM and the County (La Paz) in which the claims reside, tenure is secure.

<p><i>Exploration done by other parties</i></p>	<p><i>Acknowledgment and appraisal of exploration by other parties.</i></p>	<p>REEs were first recognised in June 2010 by John Petersen, a geologist. He submitted for analysis a reconnaissance sample from the Swansea and Bill Williams River areas that analysed 459.98 ppm Total Rare Earth Elements (TREE). A further 119 samples returned TREE values of 20.6 to 674.21 ppm. Scandium varied from 1.1 to 30.2 ppm. AusAmerican then conducted a confirmation sampling exercise of 22 samples that returned values of 6 to 588 ppm TREE, followed in February 2011 by a sample grid of 199 samples that returned 49 to 714 ppm TREE. 195 percussion drill holes were drilled in early 2011, with additional sampling was conducted in 2019 and 2020.</p> <p>AusAmerican Mining Corporation carried out all drilling, and the company was listed on the ASX.</p>
<p><i>Geology</i></p>	<p><i>Deposit type, geological setting and style of mineralisation.</i></p>	<p>The project lies within the Harcuvar metamorphic core complex within the Basin and Range Province of Arizona. Mineralisation is hosted in alkali granitic gneiss and, to a lesser extent, a structurally superimposed suite of continental red beds. REEOs occur in Allanite (epidote), which appears as fine-grained disseminations and micro-fracture fillings.</p>
<p><i>Drill hole Information</i></p>	<p><i>A summary of all information material to the understanding of the exploration results including a tabulation of the following information for all Material drill holes:</i></p>	<p>AusAmerican in 2011 contracted Dynamic Rock Solutions LLC of Salome, Arizona, to conduct exploratory drilling using a track-mounted percussion drill. Drilling began on April 20, 2011 and was completed on May 31, 2011. One hundred and ninety-five 3.5" diameter holes were complete to obtain samples of the rock types present. Holes varied in depth from 40 to 100 feet: most holes (142 of 195) were drilled to 100 feet, and total drilling totalled 18,805 feet. Distances between holes were 100 feet, and holes were situated along four lines: Lines A, B, and C were oriented NW-SE, and one, Line D, was oriented in the NE direction and crossed the other lines. The map below illustrates the La Paz percussion drill hole locations and the sample lines.</p>

		March 2021 Core Drilling: Timberline Drilling, Inc. from Elko, Nevada, used a track-mounted core rig to drill HQ diameter Core six holes were in the La Paz resource area and three additional holes were drilled on the remainder of the property. See the Drill Hole Location Map. Drilling commenced on 11 March 2021 and concluded on 31 March 2021. Drill hole depths varied between 168 feet and 403 feet for a total depth of 2,238 feet (682 meters).
	<i>easting and northing of the drill hole collar</i>	March 2021 Core Drilling: Locations of the March 2021 Core Hole data are in Appendix B of the ASX Release Technical Report 29 June 2021.
	<i>elevation or RL (Reduced Level – elevation above sea level in metres) of the drill hole collar</i>	
	<i>dip and azimuth of the hole</i>	
	<i>downhole length and interception depth</i>	
	<i>Hole length.</i>	
	<i>If the exclusion of this information is justified on the basis that the information is not Material and this exclusion does not detract from the understanding of the report, the Competent Person should clearly explain why this is the case.</i>	
<i>Data aggregation methods</i>	<i>In reporting Exploration Results, weighting averaging techniques, maximum and/or minimum grade truncations (eg cutting of high grades) and cut-off grades are usually Material and should be stated.</i>	Drill holes cuttings were collected at five-foot intervals. An approximate 2 lb. (1.36 kg) sample was submitted to ALS Chemex laboratory in Reno, Nevada, for geochemical analysis. A total of 3269 samples were submitted: all were analysed for 60 elements, including REE, Y and Sc. REE assay results from the percussion drilling program are summarised in an Appendix at the back of the report
	<i>Where aggregate intercepts incorporate short lengths of high-grade results and longer lengths of low-grade results, the procedure used for such aggregation should be stated and some typical examples of such aggregations should be shown in detail.</i>	March 2021 Core Drilling: All core was packaged in 10-foot long sections in core boxes. No aggregations of the Core were performed.
	<i>The assumptions used for any reporting of metal equivalent values should be clearly stated.</i>	
<i>Relationship between mineralisation widths and</i>	<i>These relationships are particularly important in the reporting of Exploration Results.</i>	
	<i>If the geometry of the mineralisation with respect to the drill hole angle is known, its nature should be reported.</i>	The vertical drill hole orientations, 5' sample lengths are considered appropriate to the style of flat-lying bulk tonnage mineralisation

<i>intercept lengths</i>	<i>If it is unknown and only the downhole lengths are reported, there should be a clear statement to this effect (eg 'down hole length, true width not known').</i>	
<i>Diagrams</i>	<i>Appropriate maps and sections (with scales) and tabulations of intercepts should be included for any significant discovery being reported. These should include, but not be limited to, a plan view of drill hole collar locations and appropriate sectional views.</i>	Drill hole Locations reside in the ARR report “2021 core hole analysis summary La Paz rare earth deposit La Paz county, Arizona, Appendix B” released in June 2021.
<i>Balanced reporting</i>	<i>Where comprehensive reporting of all Exploration Results is not practicable, representative reporting of both low and high grades and/or widths should be practised to avoid misleading reporting of Exploration Results.</i>	Drill hole Locations reside in the ARR report “2021 core hole analysis summary La Paz rare earth deposit La Paz county, Arizona, Appendix C and Appendix D” released in June 2021.
<i>Other substantive exploration data</i>	<i>Other exploration data, if meaningful and material, should be reported, including (but not limited to): geological observations; geophysical survey results; geochemical survey results; bulk samples – size and method of treatment; metallurgical test results; bulk density, groundwater, geotechnical and rock characteristics; potential deleterious or contaminating substances.</i>	Metallurgical test work was completed following the 2011 drilling program. Drillhole LP-B7 was twinned, and 16 samples were submitted to Saskatchewan Research Council, Saskatoon, Saskatchewan, Canada for pre-concentration and preliminary leaching tests.
		Representative rock specimens were submitted to SGS Canadian Laboratories, Vancouver, Canada, from within the resource areas to determine overall mineral assemblages and liberations/associations of REEs carriers.
		March 2021 Core Drilling: Approximately 500 kg of Core has been shipped to Nagrom Labs, in Perth Australia, for additional mineral processing and metallurgical testing.
<i>Further work</i>	<i>The nature and scale of planned further work (eg tests for lateral extensions or depth extensions or large-scale step-out drilling).</i>	March 2021 Core Drilling: Approximately 500 kg of Core has been shipped to Nagrom Labs, in Perth Australia, for additional mineral processing and metallurgical testing.
	<i>Diagrams clearly highlighting the areas of possible extensions, including the main geological interpretations and future drilling areas, provided this information is not commercially sensitive.</i>	

Section 3 Estimation and Reporting of Mineral Resources

(Criteria listed in section 1, and where relevant in section 2, also apply to this section.)

Criteria	JORC Code explanation	
Database integrity	<i>Measures taken to ensure that data has not been corrupted by, for example, transcription or keying errors, between its initial collection and its use for Mineral Resource estimation purposes.</i>	Drill hole logs are captured in the DHDB database with built-in validation for imports. Drill Hole Data was exported from DHDB and imported into Leapfrog Geo/Edge v2021.1/
	<i>Data validation procedures used.</i>	
Site visits	<i>Comment on any site visits undertaken by the Competent Person and the outcome of those visits.</i>	Competent Person visited the La Paz project site in 2011 to review drill chips, verify drill hole collar locations and critical geological observations. An additional CP (author of this current updated report visited the field in 2020 to review geology and drill sites for the upcoming core drilling program
		March 2021 Core Drilling: The Competent Person visited the site during the drilling campaign.
	<i>If no site visits have been undertaken indicate why this is the case.</i>	
Geological interpretation	<i>Confidence in (or conversely, the uncertainty of) the geological interpretation of the mineral deposit.</i>	The La Paz project area lies within the Reid Valley Basin, adjacent to the Buckskin Mountains, in the west central part of the Basin and Range Physiographic and Structural province of southwestern United States. The Buckskin Mountains are part of the Harcuvar metamorphic core complex that features exposures of a detachment fault and its mylonitic footwall. Hanging wall rocks, collectively referred to as the Upper Plate, consist of a variety of complexly normal-faulted and tilted rocks that include syntectonic, mid-Tertiary sedimentary and volcanic rocks. The footwall block, commonly referred to as the Lower Plate, is composed of variably mylonitic crystalline and meta-sedimentary rocks
		The geology at the La Paz project is not well understood at the project level and has not been mapped in detail, however principal rock units identified in chips included Tertiary red beds, gneiss and felsic intrusives
	<i>Nature of the data used and of any assumptions made.</i>	

	<i>The effect, if any, of alternative interpretations on Mineral Resource estimation.</i>	
	<i>The use of geology in guiding and controlling Mineral Resource estimation.</i>	Modelling of geological units was completed by delineating two domains conforming to the unconformable character of regional geology: Upper Plate, comprising Quaternary alluvium (Qal) and Tertiary-aged red bed conglomerate (Tc), and Lower Plate, comprising Proterozoic gneiss and Tertiary-Cretaceous felsic intrusive sills.
	<i>The factors affecting continuity both of grade and geology.</i>	Geological continuity between drill holes has been assumed and no detailed structural complexity has been incorporated.
<i>Dimensions</i>	<i>The extent and variability of the Mineral Resource expressed as length (along strike or otherwise), plan width, and depth below surface to the upper and lower limits of the Mineral Resource.</i>	The REE mineralized zones extend 900m N-S and 1200m E-W along strike and to a depth of 60m
<i>Estimation and modelling techniques</i>	<i>The nature and appropriateness of the estimation technique(s) applied and key assumptions, including treatment of extreme grade values, domaining, interpolation parameters and maximum distance of extrapolation from data points. If a computer assisted estimation method was chosen include a description of computer software and parameters used.</i>	Four (4) mineralized domains were determined using a cutoff grade of 300ppm TREE. Up to 2m of dilution material, below 300ppm TREE was included in a mineralized domain.
	<i>The availability of check estimates, previous estimates and/or mine production records and whether the Mineral Resource estimate takes appropriate account of such data.</i>	The resource estimate was checked against previous resource estimates. However, the previous resource estimate was an unconfined model with large lithological units.
	<i>The assumptions made regarding recovery of by-products.</i>	n/a
	<i>Estimation of deleterious elements or other non-grade variables of economic significance (eg sulphur for acid mine drainage characterisation).</i>	No such elements are known at this time. The La Paz project has very low levels of Thorium and Uranium that will probably not need special handling or mitigation
	<i>In the case of block model interpolation, the block size in relation to the average sample spacing and the search employed.</i>	Block model size: 20m x 20m x 2.5m; no rotation; total 2,260,000 blocks. Blocks could be sub-celled up to 5-times in each direction based on modeling domain. Resource estimate was based on an isotropic Inverse Distance Weighting (IDW) interpolation based on TREE >300ppm the minimum number of samples used to populate each block was three. A maximum

search radius of 20m and 400m was used to populate blocks for indicated and inferred resources respectively.

Search Parameters:

Purpose	General			Ellipsoid Ranges			Ellipsoid Directions			Number of Samples		Drillhole Limit
	Interpolant Name	Domain	Numeric Values	Maximum	Intermediate	Minimum	Dip	Dip Azimuth	Pitch	Minimum	Maximum	Max Samples per Hole
Estimation	ID, TREE	T01	TREE	500	500	20	0	0	0	4	20	4
Estimation	ID, TREE	T02	TREE	530	320	110	1	325	88	4	20	4
Estimation	ID, TREE	T03	TREE	500	500	10	1	106	37	4	20	4
Estimation	ID, TREE	T04	TREE	200	200	30	1	106	37	4	20	4
Validation	ID, TREE raw	T01	TREE	10	10	10	0	0	90	4	5	
Validation	Kr, TREE	T01	TREE	50	28	28	0	0	90	4	20	
Validation	NN, TREE	T01	TREE	50	28	28	0	0	90			

Any assumptions behind modelling of selective mining units.

Variogram Parameters:

General Variogram Name	Direction			Nugget	Sill	Normalised sill	Structure1			
	Dip	Dip Azimuth	Pitch				Structure	Major	Semi-major	Minor
T01: Variogram Model	2	0	0	517	3,877		1 Spherical	50	50	30
T02: Variogram Model	2	0	0	382	2,870		1 Spherical	70	100	110
T03: Variogram Model	1	0	0	0	1,905		1 Spherical	275	450	10
T04: Variogram Model	1	1	106	0	15,894		1 Spherical	8	5	2
TREE raw dataT01: Variogram Model	0	0	90	0	6,558		1 Spherical	5	5	5
TREE: Variogram Model	0	0	90	0	4,257		1 Spherical	50	28	28

Any assumptions about correlation between variables.

Description of how the geological interpretation was used to control the resource estimates.

Resource estimation was constrained by modelled mineralised domains and each domain was reported independently.

Discussion of basis for using or not using grade cutting or capping.

The grade was cut using a minimum value of 300ppm TREE. The data was not capped because of the good distribution of data. Large spikes in grade are not observed.

The process of validation, the checking process used, the comparison of model data to drill hole data, and use of reconciliation data if available.

Moisture	<i>Whether the tonnages are estimated on a dry basis or with natural moisture, and the method of determination of the moisture content.</i>	Tonnage was estimated on a dry basis
Cut-off parameters	<i>The basis of the adopted cut-off grade(s) or quality parameters applied.</i>	A cut-off grade of 300ppm TREE was used for reporting mineral resources.
Mining factors or assumptions	<i>Assumptions made regarding possible mining methods, minimum mining dimensions and internal (or, if applicable, external) mining dilution. It is always necessary as part of the process of determining reasonable prospects for eventual economic extraction to consider potential mining methods, but the assumptions made regarding mining methods and parameters when estimating Mineral Resources may not always be rigorous. Where this is the case, this should be reported with an explanation of the basis of the mining assumptions made.</i>	No mine plan or design has been prepared at this stage however the shallow nature of the deposit assumes extraction by open pit mining methods.
Metallurgical factors or assumptions	<i>The basis for assumptions or predictions regarding metallurgical amenability. It is always necessary as part of the process of determining reasonable prospects for eventual economic extraction to consider potential metallurgical methods, but the assumptions regarding metallurgical treatment processes and parameters made when reporting Mineral Resources may not always be rigorous. Where this is the case, this should be reported with an explanation of the basis of the metallurgical assumptions made.</i>	Preliminary testing of surface rock samples show that using LIMS+Rougher WHIMS mag can produce TREO recovery yields of 74.7% with a total mass yield of 23.7%. LIMS+Rougher WHIMS mag separation for Sc ₂ O ₃ can produce a recovery yield of 43.8% with a total mass yield of 23.7%.
		Direct flotation using Oleic Acid yielded 54.9% concentrate mass for 70.6% TREE, an increase of 571ppm TREE between feed grade and recovered grade.
		Direct flotation using Aero 845 yielded 71.5% concentrate mass for 86.8% TREE, an increase of 229ppm TREE between feed grade and recovered grade.
Environmental factors or assumptions	<i>Assumptions made regarding possible waste and process residue disposal options. It is always necessary as part of the process of determining reasonable prospects for eventual economic extraction to consider the potential environmental impacts of the mining and processing operation. While at this stage the determination of potential environmental impacts, particularly for a greenfields project, may not always be well advanced, the status of early consideration of these potential environmental impacts should be reported. Where these aspects have not been considered this should be reported with an explanation of the environmental assumptions made.</i>	No baseline environmental studies have been completed at this stage; however no environmental liabilities are known

Bulk density	<p><i>Whether assumed or determined. If assumed, the basis for the assumptions. If determined, the method used, whether wet or dry, the frequency of the measurements, the nature, size and representativeness of the samples.</i></p>	<p>42 core samples were collected and analysed for specific gravity using displacement. An average density of 2.68 was applied to the resource.</p> <table border="1"> <thead> <tr> <th colspan="2"></th> <th colspan="2">Density Data</th> </tr> <tr> <th rowspan="2">Lith Type Code</th> <th rowspan="2">Lithology Type</th> <th>Average of</th> <th>Count</th> </tr> <tr> <th>g/cm3</th> <th>of g/cm3</th> </tr> </thead> <tbody> <tr> <td>go</td> <td>Granodiorite</td> <td>2.59</td> <td>3</td> </tr> <tr> <td>gn</td> <td>Gneiss</td> <td>2.63</td> <td>5</td> </tr> <tr> <td>pd</td> <td>porphyry dike</td> <td>2.65</td> <td>1</td> </tr> <tr> <td>ct</td> <td>cataclasite</td> <td>2.66</td> <td>5</td> </tr> <tr> <td>gm</td> <td>mylonite gneiss</td> <td>2.70</td> <td>26</td> </tr> <tr> <td>dk</td> <td>dike</td> <td>2.72</td> <td>1</td> </tr> <tr> <td>ga</td> <td>gabbro/ultramafic</td> <td>2.85</td> <td>1</td> </tr> <tr> <td colspan="2">Total</td> <td>2.68</td> <td>42</td> </tr> </tbody> </table>			Density Data		Lith Type Code	Lithology Type	Average of	Count	g/cm3	of g/cm3	go	Granodiorite	2.59	3	gn	Gneiss	2.63	5	pd	porphyry dike	2.65	1	ct	cataclasite	2.66	5	gm	mylonite gneiss	2.70	26	dk	dike	2.72	1	ga	gabbro/ultramafic	2.85	1	Total		2.68	42
			Density Data																																									
	Lith Type Code	Lithology Type	Average of	Count																																								
g/cm3			of g/cm3																																									
go	Granodiorite	2.59	3																																									
gn	Gneiss	2.63	5																																									
pd	porphyry dike	2.65	1																																									
ct	cataclasite	2.66	5																																									
gm	mylonite gneiss	2.70	26																																									
dk	dike	2.72	1																																									
ga	gabbro/ultramafic	2.85	1																																									
Total		2.68	42																																									
<p><i>The bulk density for bulk material must have been measured by methods that adequately account for void spaces (vugs, porosity, etc.), moisture and differences between rock and alteration zones within the deposit.</i></p>	<p>The deposit contains few voids, is relatively dry and alteration is generally not extensive enough to affect density. The samples tested for density are representative and the resource material.</p>																																											
<p><i>Discuss assumptions for bulk density estimates used in the evaluation process of the different materials.</i></p>																																												
Classification	<p><i>The basis for the classification of the Mineral Resources into varying confidence categories.</i></p>	<p>Drilling data from 2011 and 2021 was separated into four mineralised domains using 300ppm TREE as the defining parameter. In the block model, the indicated class is limited to a distance of 50m from a drill hole. Inferred resources extent from 50m to the boundaries of the model.</p>																																										
	<p><i>Whether appropriate account has been taken of all relevant factors (i.e. relative confidence in tonnage/grade estimations, reliability of input data, confidence in continuity of geology and metal values, quality, quantity and distribution of the data).</i></p>	<p>This arbitrarily assigned classification is considered to be fair and reasonable. Proportionally, the indicated resource amounts to 21% of the total resource.</p>																																										
	<p><i>Whether the result appropriately reflects the Competent Person's view of the deposit.</i></p>	<p>The results represent the Competent Person's view of the deposit.</p>																																										

<i>Audits or reviews</i>	<i>The results of any audits or reviews of Mineral Resource estimates.</i>	The resource estimate was developed Odessa Resources Pty Ltd in July 2021. No audits or reviews, outside of Westen Rare Earths personnel have been performed.
<i>Discussion of relative accuracy/ confidence</i>	<i>Where appropriate a statement of the relative accuracy and confidence level in the Mineral Resource estimate using an approach or procedure deemed appropriate by the Competent Person. For example, the application of statistical or geostatistical procedures to quantify the relative accuracy of the resource within stated confidence limits, or, if such an approach is not deemed appropriate, a qualitative discussion of the factors that could affect the relative accuracy and confidence of the estimate.</i>	Odessa Resources Pty performed classical and geostatistical analysis of the data. The results of these examinations reside in the text of the attached report.
	<i>The statement should specify whether it relates to global or local estimates, and, if local, state the relevant tonnages, which should be relevant to technical and economic evaluation. Documentation should include assumptions made and the procedures used.</i>	At this time the resource model has not been used for any economic assessment.
	<i>These statements of relative accuracy and confidence of the estimate should be compared with production data, where available.</i>	

Appendix B

Review of 2021 SRC Testwork Program Results

Document No. 607630-0000-DC00-RPT-0001

Amec Foster Wheeler Australia Pty Ltd (trading as Wood)

August 2021



American Rare Earths Limited

La Paz Rare Earths Project

Review of 2021 SRC Testwork Program Results

Disclaimer

This Review of 2021 SRC Testwork Program Results (Report) has been prepared for American Rare Earths Limited (AREL) by Amec Foster Wheeler Australia Pty Ltd (trading as Wood), based on assumptions as identified throughout the text and rely upon information and data supplied by others.

The Report is to be read in the context of the methodology, procedures and techniques used, Wood's assumptions, and the circumstances and constraints under which the Report was written. The Report is to be read as a whole, and sections or parts thereof should therefore not be read or relied upon out of context.

Wood has, in preparing the Report, followed methodology and procedures, and exercised due care consistent with the intended level of accuracy, using its professional judgment and reasonable care. All estimates and other values are only valid as at the date of the Report and will vary thereafter.

Information reviewed in the Report has been prepared or arranged by third-party contributors appointed by American Rare Earths Limited, as detailed in the document. While the contents of those parts have been generally reviewed by Wood for inclusion into the Report, they have not been fully audited or sought to be verified by Wood. Wood is not in a position to, and does not, verify the correctness, accuracy or completeness of, or adopt as its own, the information and data supplied by others and disclaims all liability, damages or loss with respect to such information and data.

In respect of all parts of the Report, whether or not prepared by Wood no express or implied representation or warranty is made by Wood or by any person acting for and/or on behalf of Wood to any third-party that the contents of the Report are verified, accurate, suitably qualified, reasonable or free from errors, omissions or other defects of any kind or nature. Third parties who rely upon the Report do so at their own risk and Wood disclaims all liability, damages or loss with respect to such reliance.

Wood disclaims any liability, damage and loss to American Rare Earths Limited and to third-parties in respect of the publication, reference, quoting or distribution of the Report or any of its contents to and reliance thereon by any third party.

This disclaimer must accompany every copy of this Report, which is an integral document and must be read in its entirety.

CERTIFICATE OF QUALIFICATIONS
GREG HENDERSON
PROCESS CONSULTANT
WOOD plc

I, Gregory K. Henderson, hereby certify that:

- I am currently a Process Consultant working for Wood (ACN 118514444) and have been engaged by American Rare Earths to undertake process development investigations for the La Paz Project.
- I am a graduate of Curtin University (1983) and hold a Bachelor of Applied Science in Metallurgy. I have been practicing in my profession since 1984.
- I am a Fellow of The Australasian Institute of Mining and Metallurgy (AusIMM), number 109007.
- From 1984 to present I have been actively employed in various capacities in the mining industry, with assignments in numerous locations around the world.
- I have read and understood the requirements of the 2012 Edition of the Australasian Code for Reporting of Exploration Results, Mineral Resources and Ore Reserves (JORC Code, 2012 Edition).
- I am a Competent Person as defined by the JORC Code 2012 Edition, having sufficient experience that is relevant to investigating treatment routes for the style of mineralisation and type of deposit described in the Report, and to the activity for which I am accepting responsibility.
- I verify that the Report is based on, and fairly and accurately reflects in the form and context in which it appears, the information in my supporting documentation relating to exploitation of this resource.
- As of the effective date of the report, to the best of my knowledge, information and belief, the technical report contains all scientific and technical information that is required to be disclosed to make the report not misleading.
- I consent to the filing of this report with any stock exchange and other regulatory authority and publication by them, including publication of the report in the public company files on their websites accessible by the public.

Dated in Perth, Western Australia this 11th day of August 2021

Gregory K. Henderson
B.App.Sc (Metallurgy), FAusIMM 109007

Table of Contents

Disclaimer	3
1 Executive Summary	7
1.1 Overview	7
1.2 Key Results	7
1.2.1 Magnetic Separation.....	7
1.2.2 Flotation.....	8
1.2.3 Other Strategies.....	8
1.3 Drill Core Testing Program.....	8
2 Introduction	10
3 Discussion of Results.....	11
3.1 Sample Selection and Ore Characterisation.....	11
3.2 Stage 1 Sighter Testwork	12
3.2.1 Dry Magnetic Separation	12
3.2.2 Sighter Wet Magnetic Separation	12
3.3 Stage 2 Testwork	14
3.3.1 WHIMS Concentrate Production.....	14
3.3.2 Sighter Flotation Testing.....	15
4 Conclusions and Recommendations for Further Work.....	20
4.1 Key Conclusions	20
4.1.1 Magnetic Separation.....	20
4.1.2 Flotation.....	20
4.1.3 Other Strategies.....	21
4.2 Drill Core Testing Program.....	21

List of Tables

Table 3.1 : Comparison of Key Head Sample Analyses	11
Table 3.2 : Preliminary Dry Separation by Size Class	12
Table 3.3 : Preliminary Wet Magnetic Separation Results.....	13
Table 3.4 : Rougher-Scavenger WHIMS Results.....	14
Table 3.5 : Cleaner-Scavenger WHIMS Results.....	14
Table 3.6 : Preliminary Literature Search Findings (Allanite Specific)	15
Table 3.7 : Flotation Testing Regime.....	17



Table 3.8 : Summary of Flotation Test Results17

List of Figures

Figure 3.1 : Cumulative TREE Product Recovery-Grade Curves.....19

List of Attachments

Attachment 1 SRC Testwork Report

1 Executive Summary

1.1 Overview

American Rare Earths Limited (AREL) commissioned Amec Foster Wheeler Australia Pty Ltd (trading as Wood), to manage and interpret a testwork program on supplied surface rock chips collected from the La Paz Rare Earths Project in Arizona USA. This work follows on from a review undertaken of historical work conducted by Wood on La Paz ore in 2011/12, which identified that combinations of magnetic separation and flotation have potential to beneficiate the ore prior to downstream acid baking and metal extraction.

A diamond drilling program was completed in Q1 2021 and cores have since been assayed and a metallurgical composite prepared for further process development at Nagrom Ltd in Perth Australia. This program is just commencing at the time of preparation of this report.

In order to progress development whilst waiting for the drill cores to become available, AREL provided bags of rock chips obtained from surface outcrops of the deposit. It was acknowledged that these samples may not be typical of the orebody at depth, but the intent was to progress from earlier SRC testwork to explore enrichment options.

The initial program comprised the following components:

- Preliminary dry high intensity magnetic separation of separate size fractions using a Frantz separator
- Sighter wet high intensity magnetic separation (WHIMS) with stage grinding.

Magnetic concentrate was later produced to undertake sighter flotation testwork for the purpose of collector screening ahead of the main drill core testing program at Nagrom in Perth, Australia.

1.2 Key Results

1.2.1 Magnetic Separation

- A combination of low and high intensity magnetic separation is an expedient means of pre-concentrating La Paz ore. A combined LIMS and two stage WHIMS concentrate yielded 10.3% mass at 1921 ppm TREEs from a feed of 552 ppm but recovery is low at 36%.
- Using rougher WHIMS only in combination with LIMS, preliminary work conducted in this study produced a concentrate with 1744 ppm TREEs and 30 ppm Sc for 74.7% and 43.8% recovery respectively, rejecting 76% of feed mass, a very promising outcome.
- Applying scavenging to cleaner magnetic separation boosts recovery at a similar grade to LIMS/rougher WHIMS concentrate grade.
- WHIMS may be limited in effectiveness at fine sizes (below 20 microns), which impacts on recovery and selectivity against gangue minerals. However, incomplete liberation of RE minerals may also be a factor in limiting upgrade without excessive losses.
- Further work is needed to optimise primary and secondary grind sizes, which will be guided by mineralogical locking analysis data from planned QEMSCAN work.

1.2.2 Flotation

- Flotation of magnetic concentrate yielded some promising results for further consideration, although the concentrate produced for this work was of much lower grade and recovery than the initial sighter work.
- Of the reverse silica flotation tests, Wood recommends giving further consideration to Flotigam EDA and other diamine ether collectors for reverse flotation, such as Flotigam 2835-2 and the Lilafлот range, based on experience with other reverse flotation projects Wood is involved with.
- For direct RE flotation, Wood recommends continuing investigation into oleic acid and Aero 845, given their relatively lower costs compared with Aero 6493.
- Whilst Aero 6493 did achieve good upgrade and recovery, it is an expensive reagent, typically US\$12/kg, compared with Aero 845 at US\$2.80/kg and oleic acid at US\$2.10/kg. Supply security is also a concern as it is only made in one factory in Mexico on a twice yearly basis. It needs to be maintained at 15 deg C temperature with heaters to avoid its components separating out in cold weather, an issue for Arizona in winter months, adding to operating costs.
- Other collectors, depressants and modifiers will also be investigated in the next program. Reagents tested were limited to what SRC could access in the time available but there are other new generation fatty acid reagents that could also be effective with La Paz ore for direct flotation.
- As feldspars are the major gangue component, investigation into reverse flotation should also be evaluated. Traditionally, feldspar is floated under acidic conditions with fluorosilicic acid as collector, which is a toxic reagent, but new developments may offer safer and less onerous alternatives.

1.2.3 Other Strategies

- Work in this program has focussed on magnetic separation as a primary beneficiation method, as well as a pre-concentration step ahead of flotation
- Further work to improve grade and recovery of the magnetic concentrate is needed ahead of upgrading with flotation in order to reduce unit reagent consumptions
- No work has been undertaken on flotation as a primary separation method so far and is worth investigating to simplify the flowsheet
- The locking of allanite at fine particle sizes, indicated in historical work, will remain the largest challenge for achieving high levels of upgrading
- To provide a clear path forward for future work, comprehensive mineralogical analysis is required to understand the deportment of RE minerals within the La Paz ore in order to determine how the fineness of grind necessary to achieve liberation. From historical work, much of the value is locked below 25 microns, but the extent of fine grinding needs to be understood to determine how feasible it is to achieve significant upgrading, i.e. to 0.5 to 1% TREEs ahead of downstream processing.

1.3 Drill Core Testing Program

A testwork program has been developed and approved for execution by AREL, which commenced in early August, and is expecting to run for 3 to 4 months depending on outcomes and side investigations. 500 kg of

diamond core selected by AREL from the 2021 drilling program has been delivered to Nagrom for testing. The key modules of work planned are as follows:

1. Feed characterisation and mineralogy, including QEMSCAN, SEM and EMPA.
2. Magnetic separation – Davis Tube Recovery, LIMS and WHIMS.
3. Flotation - Further sighter reverse and direct flotation on un-beneficiated feed and magnetic concentrate and bulk concentrate production with optimised beneficiation conditions.
4. Concentrate treatment - preliminary acid bake testing of bulk concentrate followed by water leaching. Testing of the proprietary Watts and Fisher process which employs atmospheric leaching of RE elements without the need for acid baking or autoclaves will be undertaken.

The outcomes of this program should provide the necessary information to enable a preliminary economic evaluation (PEA) for the project to be undertaken.

2 Introduction

The La Paz Rare Earth Project, located in La Paz County, Arizona USA, is a large low grade silicate-hosted rare earth deposit owned by American Rare Earths Limited (AREL) with average total rare earth elements (TREEs) content of 398 ppm with a cut-off grade of 300 pm. "Magnet metals" (primarily neodymium with praseodymium, dysprosium and terbium) make up around 27% of the TREE content¹. Scandium content averages 16 ppm and is also of interest to AREL.

Work undertaken at the Saskatchewan Research Council (SRC) going back to 2011 determined that the REEs contained within rare earth minerals respond to wet high intensity magnetic separation (WHIMS). Direct allanite flotation was also given preliminary assessment, treating screened minus 45 microns material, with plus 45 microns material being processed with WHIMS. Through mineralogical analysis, it was reported that not all of the allanite contains rare earths. However, targeting allanite and monazite in beneficiation strategies should ensure the best opportunity of recovering rare earth values. Scandium deportment is not currently known, and will be discussed in this report, and its recovery does not necessarily follow rare earths in the same proportion.

A diamond drilling program was planned for 2020 but suffered delays in permitting and execution due to COVID-19 constraints. The program was completed in Q1 2021 and cores have since been assayed and a metallurgical composite prepared for further process development at Nagrom Ltd in Perth Australia. This program is just commencing at the time of preparation of this report.

In order to progress development whilst waiting for the drill cores to become available, AREL provided bags of rock chips obtained from surface outcrops of the deposit. It was acknowledged that these samples may not be typical of the orebody at depth, but the intent was to progress from earlier SRC testwork to explore enrichment options. Wood undertook a review of historical testwork in a report² issued in 2020, the finding of which were used as the basis for an interim program using the rock chip samples.

Given their earlier involvement and familiarity with the resource, as well as having recognised expertise in allanite beneficiation through several scientific publications, the SRC was commissioned to undertake exploratory testwork of mineralised rock chips in the interim period while the diamond drilling program is conducted.

The initial program comprised the following components:

- Preliminary dry high intensity magnetic separation of separate size fractions using a Frantz separator
- Sighter wet high intensity magnetic separation (WHIMS) with stage grinding.

Subsequent to Stage 1, a bulk magnetic concentrate was produced for the purposes of screening of flotation collectors ahead of the main drill core program, designated Stage 2. This work was undertaken on an additional composite of rock chips derived from the same provided bags to ensure internal consistency in the program.

¹ D. Kinnes, 2021 "Core Hole Analysis Summary", June 2021.

² Wood, "La Paz Project - Review of Metallurgical Testwork Data and Program", Feb 2020.

SRC has produced a testwork report which encompasses both testwork stages, appended to this report (see Attachment 1). Key findings from SRC's work are summarised in this report, along with an outline of the program currently being undertaken at Nagrom.

3 Discussion of Results

3.1 Sample Selection and Ore Characterisation

Rock chip samples were selected from the surface of the main zone of the La Paz orebody, designated MET-01 to MET-32, for a total mass of 72 kg. For Stage 1 work, a 5 kg composite from all samples was prepared, whilst for Stage 2 bulk composite preparation, 35 kg was composited. Table 3.1 summarises key analyses of the composited samples.

Component	Unit	Stage 1
LREE	ppm	448
HREE	ppm	103
TREE	ppm	552
Magnetic REEs [^]	ppm	140
Sc	ppm	15
Fe ₂ O ₃	%	7.1
SiO ₂	%	59.9
Al ₂ O ₃	16.6	16.6
Ba	ppm	1410
ThO ₂	ppm	19.8
U ₃ O ₈	ppm	7.2

[^] Note: magnetic REEs are Nd, Pr, Tb and Dy.

The ore is very low in thorium and uranium which is beneficial from an environmental and handling perspective, though upgrading along with REE content is inevitable as these elements tend to be associated with monazite. Association with allanite warrants further investigation in planned QEMSCAN work in the current Nagrom program.

TREEs at 552 ppm can be considered above average for the delineated resource. Scandium is present at a low level of 15 ppm. Primary scandium grades of orebodies being developed currently range from 300 to 400 ppm but recovery may be viable as a by-product of REE production, which will be the subject of future work once mineral associations are better understood. Due to the low levels of REEs in the raw ore form, allanite could not be detected by XRD, but has been previously identified as the main carrier mineral for REEs.

Silica is the largest component of the ore at nearly 60% of total mass, followed by Al₂O₃ at 16.6% and Fe₂O₃ at 7.1%. Aluminium and silicon are intimately associated with a range of feldspar minerals, including albite,

anorthite, clinozoisite (a sorosilicate in the epidote group), chamosite (a chlorite mineral) and biotite (a member of the mica family). Silicon as silica makes up only 27% of total mass.

Assay by size of the Stage 1 sample was milled to minus 150 microns and subjected to assay by size analysis. No significant enrichment or deletion by size fraction was noted, with all TREEs well in excess of the resource cutoff grade of 300 ppm.

3.2 Stage 1 Sighter Testwork

Preliminary work was carried out on a 5 kg composite to evaluate magnetic susceptibility responses ahead of cleaner separation work.

3.2.1 Dry Magnetic Separation

A Frantz Separator was used for the preliminary evaluation, which operates in dry mode with very small sample sizes, so is useful for initial characterisation work. Unfortunately, it does not correlate directly with WHIMS units in terms of field strength measured in gauss but provides a relative measure of performance.

Minus 25 microns material was screened out of a 1 kg split of the Stage 1 ore composite that had been milled to minus 150 microns. The screened material was then separated into four size classes and tested separately. Table 3.2 summarises these preliminary findings.

Size Class µm	Mass %	Preliminary MS Recovery		Combined Magnetics			
		Fe ₂ O ₃ , %	TREE, %	LREE, ppm	HREE, ppm	TREE, ppm	Fe ₂ O ₃ , wt%
106-150	35.4	90.6	82.4	367	74	441	7.1
75-106	17.0	94.6	87.2	688	72	760	8.2
38-75	30.0	88.8	83.0	1020	182	1202	10.5
25-38	17.6	84.5	79.6	1065	192	1257	11.3

Key observations are:

- TREE recovery was relatively stable across the range of sizes tested, from 80 to 87%, dropping off in the finest fraction of 25 to 38 microns
- REE grade increased with finer size fractions, indicating the ore benefits from finer grinding to liberate rare earth minerals, primarily allanite
- Iron oxide grades in magnetic concentrate also increase with finer grind sizes, which is expected with the use of high intensity magnetic separation.

3.2.2 Sighter Wet Magnetic Separation

3.2.2.1 Rougher-Cleaner Magnetic Separation

A 1.8 kg sub-sample of the stage 1 ore composite was milled to 80% passing 75 microns and subjected to wet LIMS processing at 1000 gauss to remove magnetite and other diamagnetic minerals, followed by WHIMS

processing at 10000 gauss field strength (1 Tesla). The concentrate was then reground to 80% passing 38 microns and subjected to cleaner WHIMS processing. Table 3.3 summarises the results of the various separation stages, arranged with different combinations of magnetic products.

Table 3.3 : Preliminary Wet Magnetic Separation Results					
	Mass, %	TREEs, ppm	TREEs Distn, %	Sc, ppm	Sc Distn, %
Feed	100.0	552	100.0	16.0	100.0
LIMS mags	4.0	912	6.6	22.0	5.5
Rougher WHIMS mags	19.6	1914	68.1	31.2	38.3
Cleaner WHIMS mags	6.3	2560	29.3	42.0	16.6
LIMS+Cleaner WHIMS mags	10.3	1921	36.0	34.2	22.1
LIMS+Rougher WHIMS mags	23.7	1744	74.7	30.4	43.8

Key findings were as follows:

- LIMS processing produced a small concentrate mass with 6.6% of total REEs
- Rougher WHIMS produced a good upgrade to 1914 ppm TREEs, containing 68.1% of total feed TREEs
- Regrinding and cleaner WHIMS saw the concentrate grade increase to 2560 ppm TREEs but at the expense of recovery, reducing to 29.3% of total feed TREEs
- Scandium recovery was lower than REEs which suggests association with unrecoverable rare earth minerals or with non-magnetic minerals. Mineralogical work is required to explore these associations, which is planned in the current Nagrom program
- Although not included in the above table, only 13% of feed iron was recovered to wet LIMS concentrate at 1000 gauss, indicating low magnetite content. 35% was recovered to WHIMS rougher concentrate, which was then reduced to only 14.9% in cleaner WHIMS concentrate. XRD analysis indicates iron is primarily present in biotite, which is paramagnetic, as well as chlorite and clinzoisite, which are non-magnetic, with little evidence of the commercial minerals magnetite and hematite being present
- Scavenger tests on rougher and cleaner WHIMS tailings were commissioned to determine if recovery can be increased at similar grades.

3.2.2.2 Sighter Scavenger Magnetic Separation

Rougher and Cleaner WHIMS tailings were subjected to three passes of scavenger WHIMS processing at a field strength of 10000 gauss, the results being presented in Table 3.4. Recovery of REEs and Sc with the introduction of rougher scavenging increased marginally, with a reduction of weighted combined grades noted. On the basis of this result, scavenger WHIMS is not warranted.

Table 3.4 : Rougher-Scavenger WHIMS Results					
	Mass, %	TREEs, ppm	TREEs Distn, %	Sc, ppm	Sc Distn, %
Stage Performance					
Ro Sc mags	8.0	710	7.9	26.0	22.0
Ro Sc WHIMS mags	92.0	308	83.3	8.0	78.0
Feed (Ro WHIMS non-mags)	100.0	340	100.0	9.4	100.0

Scavenging of cleaner WHIMS tailings was undertaken to determine if REEs and Sc recovery could be increased further as 34% of feed REEs reported to this stream. Table 3.5 presents the results of this test.

Table 3.5 : Cleaner-Scavenger WHIMS Results					
	Mass, %	TREEs, ppm	TREEs Distn, %	Sc, ppm	Sc Distn, %
Stage Performance					
Cleaner scavenger mags	27.0	1789	31.2	38.0	43.8
Cleaner scavenger non-mags	73.0	1457	68.8	18.0	56.2
Feed (Cleaner WHIMS non-mags)	100.0	1547	100.0	23.4	100.0

Scavenging of cleaner non-magnetics recovered 31.2% of lost TREEs at a grade of 1789 ppm, increased from 1547 ppm in stage feed. This stage improves the overall recovery whilst diluting grade only slightly.

43.8% of contained scandium was also recovered at a grade of 38 ppm. Scavenging of cleaner WHIMS tailings appears to have merit and should be incorporated in future testing flowsheets.

The reason for high losses of REEs to non-magnetics needs to be understood, which will require mineralogical investigations. Higher field strengths may be required to achieve this, particularly for finer sizes where WHIMS loses efficiency.

3.3 Stage 2 Testwork

A new 35 kg composite was prepared from available rock chip samples, made up in identical proportions to the Stage 1 sample. As discussed in the introduction, this sample was produced to undertake sighter flotation work for collector screening purposes ahead of the main drill core program. Given the large range of collectors that could be used, for both reverse and direct flotation, as well as modifiers and promoters to improve selectivity, only a limited assessment could be undertaken, but the work provided good direction for further investigations.

3.3.1 WHIMS Concentrate Production

As the purpose of generating the concentrate was to produce mass for downstream sighter work, an abbreviated beneficiation route was taken to conserve costs and time. The new sample was stage crushed to minus 2 mm and milled in a lab rod mill to a P₈₀ of 75 microns followed by rougher WHIMS processing at 10000 gauss field strength.

Mass yield was quite low at 16.7% of original feed, grading 1279 ppm TREEs for 38.6% recovery. SRC performed limited analysis on this sample aside from the lanthanide suite of elements given it was produced for external purposes. The upgrade is quite poor because the sample was only milled to 80% passing 75 microns, reinforcing the need to grind to a fine size to liberate rare earth minerals from gangue. Most flotation tests were, however, undertaken at a P₈₀ of 38 microns to improve selectivity against gangue minerals.

3.3.2 Sighter Flotation Testing

Wood conducted a preliminary review of published literature relating to allanite flotation. As this is a narrow field, the number of researchers is limited. A summary of more prominent investigations is provided here as Table 3.6.

Table 3.6 : Preliminary Literature Search Findings (Allanite Specific)		
Author and Year	Context	Findings
Jordens et al, 2014	Flotation of allanite from silica	<ul style="list-style-type: none"> Dodecylamine collector at 20 g/t at pH 7 reverse floats 60% of silica without loss of allanite. Sodium oleate and benzohydroxamic acid trialled for direct allanite flotation but don't appear to work, possible due to the low REE content in allanite (as low as 7%) which provides limited sites for chemisorption Benzohydroxamic acid flotation of allanite and silica is improved when using a strong frother such as F150 (polyglycol ether) but is still not selective.
Xia et al, 2015	Thor Lake, lead nitrate activation	<ul style="list-style-type: none"> Thor Lake is a mixed RE assemblage, including allanite. Suggested by Finklestein (1997), lead nitrate as an activator for RE minerals was considered promising. Modest increase in REE increase (10 to 15%) noted.
Jordens, 2016	Nechalacho plant design	<ul style="list-style-type: none"> The deposit is a mix of allanite, bastnaesite, synchysite and monazite. The plan is to employ gravity separation and WHIMS for recovery. Benzohydroxamic acid trialled for mixed RE mineral flotation. Allanite did not float as well as other minerals. Addition of lead chloride instead of nitrate boosted allanite recovery by a larger margin than the other RE minerals present, but at the expense of grade as silica is also activated by lead. Additional cleaning may assist with silica rejection.

Table 3.6 : Preliminary Literature Search Findings (Allanite Specific)		
Author and Year	Context	Findings
Kursun et al, 2019	Surface chemistry investigations of allanite	<ul style="list-style-type: none"> • Evaluation of Flotigam EDA (ethyl diamine) and R845 (a sulfosuccinamate) for direct allanite flotation. • R845 (commercially known as Aero 845) produced superior allanite grade/recovery to EDA. Flotigam EDA achieved higher recovery but poor selectivity against silicate gangue minerals despite using high dosage of sodium silicate depressant.

Of the preceding investigations, Aero 845 looked promising for testing, as did the use of lead salts. Sodium oleate also has been demonstrated to work but is not overly selective so must be coupled with depressants.

There are certain challenges with direct flotation of La Paz ore:

- Silica content at 27% limits reverse silica potential with amines but could be a useful primary separation method as the reagent regime is not complex
- Allanite is a sorosilicate so may have selectivity issues against clinozoisite. XRD will be able to identify if this is the case in the Nagrom work
- A larger amount of gangue is associated with feldspar and mica minerals, which merits attention as opposed to simple silica flotation, but identifying optimal conditions will take significant experimentation
- Magnesium, present in the mineral chamosite in La Paz ore, can potentially act as a depressant for silica, an occurrence seen in magnetite reverse silica flotation work undertaken by Wood and observed in Brazilian operations. EDTA addition can be useful for reversing this effect if reverse silica flotation is desirable but is equally useful for depressing silica in direct allanite flotation.

Ms Lucia Xi of the SRC, as a researcher who is published in this field, was consulted for her view on appropriate regimes for testing of allanite response to flotation. Wood also wished to trial reverse silica flotation as a preliminary means of upgrading ahead of direct flotation.

The following testing regime in Table 3.7 was selected for the eight tests undertaken.

Test	P ₈₀ , µm	Context	Collector	Depressant	Frother	Activator	Pulp pH
F1	75	Silica flotation	Armac T	Modified starch	Dowfroth	-	9.0
F2	75	Silica flotation	Flotigam EDA	Modified starch	Dowfroth	-	9.0
F3	63	Silica flotation	Flotigam 4343	Modified starch, CMC	Dowfroth		7.4
F4	63	Silica flotation	Aero 3030	Modified starch	Dowfroth	Lead acetate	7.0
F5	38	Silica flotation	Flotigam EDA	Modified starch	Dowfroth	-	9.0
F6	38	RE flotation	Oleic acid	Modified starch Sodium silicate	Dowfroth	-	9.0
F7	38	RE flotation	Aero 845	Modified starch	Dowfroth	-	8.0
F8	38	RE flotation	Aero 6493	Modified starch Sodium silicate	Dowfroth	Lead nitrate	9.0

Table 3.8 summarises testwork results for the eight tests, comprising recovery to “sinks” for the reverse flotation tests (F1 to 5) and “floats” for direct RE flotation (Tests F6 to 8). The initial flotation feed TREEs assay was 1279 ppm. However, reconciled (back-calculated) head grade from the individual product and tails did not agree well in some instances (ranging from 1005 to 1413 ppm), producing some inconsistencies in grade-recovery results. To aid understanding of relative TREE content upgrades, calculated feed assays for each test are also included in the table.

Test	Collector	Product	Cum. Float Time, mins	Product Mass Yield, %	Calc, Feed TREE Grade, %	Product TREE Grade, %	Product TREE Recovery, %
F1	Armac T	Sinks	7	81.2	1413	1490	85.6
F2	Flotigam EDA	Sinks	5	42.2	1260	1398	46.8
F3	Flotigam 4343	Sinks	5	78.6	1209	1208	78.5
F4	Aero 3030	Sinks	4	48.1	1098	1163	49.1
F5	Flotigam EDA	Sinks	9	40.3	1070	1580	34.0
F6	Oleic acid	Floats	7	54.9	1005	1576	70.6
F7	Aero 845	Floats	6	71.5	1066	1295	86.8
F8	Aero 6493	Floats	6	47.4	1039	1491	68.1

3.3.2.1 Reverse Silica Flotation

Armac T (Test F1) as a silica collector produced a weak response, with only 18.8% mass reject to “floats”. Recovery of TREEs and “sinks” grade were comparatively similar at 85.6% and 81.2% respectively. Little upgrading of feed assay occurred (1413 to 1490 ppm).

Flotigam EDA was used in two tests – F2 at a P_{80} of 63 microns and F5 at a P_{80} of 38 microns. Both tests yielded good upgrades, with the later producing the highest sinks TREEs grade of 1580 ppm from a starting assay of 1070 ppm. Recovery to sinks was low at 34%, as was mass yield at 40.3%, which suggests insufficient liberation. Test F5 featured an extended flotation time of 89 minutes compared to 5 minutes in Test F2, which resulted in more mass reporting to froth rejects, carrying value TREEs with it. The inference from this is insufficient liberation of REE minerals but mineralogy is needed to confirm this ahead of future work,

Flotigam 4343 (Test F3) rejected around 21% mass to floats but no selectivity against REE minerals occurred, resulting in the sinks being the same grade as flotation feed.

Aero 3030 (Test F4) returned a similar response though mass rejection was higher. The grade increased from 1098 ppm in feed to 1163 ppm in sinks, demonstrating poor selectivity. Lead acetate was added on the recommendation of SRC to boost silica selectivity but was not found to work well with Aero 4030 in this instance.

Of the silica collectors tested, Flotigam EDA shows the most promise. However, EDA is a mono amine so collecting power is weaker than the diamine series such as Flotigam 2835-2, which was not tested due to SRC not having any in stock for testing. Future work will evaluate these stronger collectors offered by Clariant, as well as other makes such as the Lilafлот series, which are readily available from vendors for testing in Australia.

3.3.2.2 Direct RE Flotation

Test 6 featured the use of oleic acid as the RE collector, with sodium silicate added to assist starch with gangue mineral depression and dispersion. This test yielded 54.9% concentrate mass for 70.6% TREEs recovery, at a grade of 1575 ppm from a feed assay of 1005 ppm. This result is extremely promising as the upgrade was quite high but at the same time, recovery was also high, which suggests very good selectivity against silica and feldspar gangue.

Test F7 used Aero 845 as the collector, which is used for flotation of barite primarily. In certain African rare earth projects, significant levels of barite are present, and “pre-flotation” of barite is needed ahead of RE flotation, otherwise the barite will co-float along with RE minerals such as bastnaesite and monazite. In this test, 58.3% of feed barium reported to concentrate, but it is unlikely to be barite as the head analysis indicated less than 100 ppm sulphur in original feed, determined by Leco analyser. The form of barium minerals present therefore remains unclear at the moment, though it is possibly present as barium silicate (sanbornite) given the larger number of silicate minerals present general feldspar assemblage. TREEs upgrade was relatively modest, increasing from a feed of 1066 ppm to 1295 ppm in concentrate, for 86.8% recovery into 71.5% mass yield. However, only a single test was performed and RE minerals may not be sufficiently liberated for Aero 845 to be fully effective. It is a relatively economical reagent compared to the Flotigam reagents, so is worth further investigation.

The final Test (F8) used Aero 6493, an alkyl hydroxamate collector that is commonly used for the flotation of bastnaesite, the most common commercially recovered rare earth mineral globally, accounting for over 80% of production. In this test, high upgrade was achieved, comparable to Test F6 with oleic acid, with the grade increasing from 1039 ppm in the feed to 1491 ppm in concentrate for 68.1% recovery. The recovery-grade response for Aero 6493 was at odds with the preceding two tests because cumulative TREEs grade is seen to increase over time, not decrease, indicating that the RE minerals are slower floating with this reagent but at

the same time, selective against gangue. The float also looks to have not been finished after the final sixth stage as the grade of this final concentrate was the highest at 1608 ppm.

Comparative recovery-grade responses for the eight tests performed are presented here as Figure 3.1. Product curves for reverse flotation tests are for sinks whilst direct RE float tests are for froth (floats), which provides a useful comparison of efficacy. The comparison clearly indicates the superior selectivity of oleic acid (F6) and Aero 845 (F7) over the other tests, including reversed flotation. F8 with Aero 6493 bears further investigation due to the unusual recovery-grade response.

Figure 3.1 : Cumulative TREE Product Recovery-Grade Curves

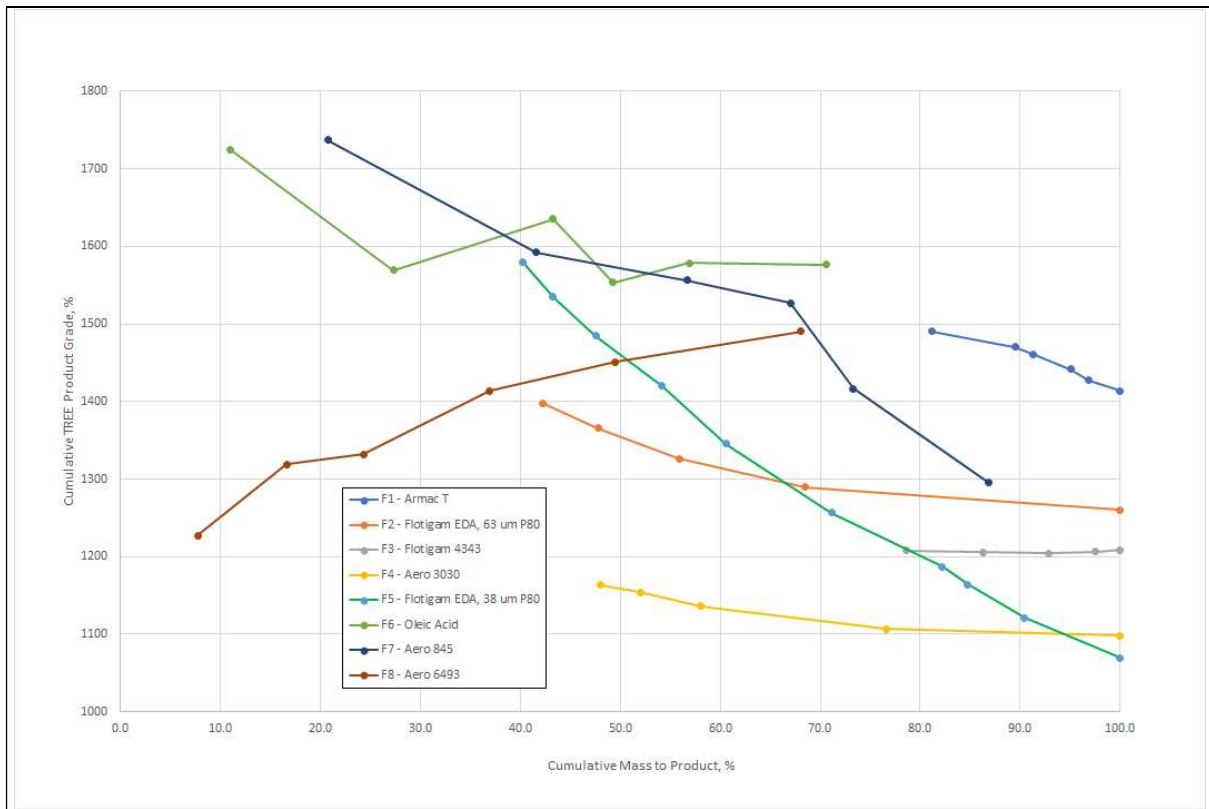

4 Conclusions and Recommendations for Further Work

4.1 Key Conclusions

4.1.1 Magnetic Separation

- A combination of low and high intensity magnetic separation is an expedient means of pre-concentrating La Paz ore.
- WHIMS may be limited in effectiveness at fine sizes (below 20 microns), which impacts on recovery and selectivity against gangue minerals. However, incomplete liberation of RE minerals may also be a factor in limiting upgrade without excessive losses.
- Using rougher WHIMS only in combination with LIMS, preliminary work conducted in this study produced a concentrate with 1744 ppm TREEs and 30 ppm Sc for 74.7% and 43.8% recovery respectively, rejecting 76% of feed mass, a very promising outcome.
- Applying a cleaner scavenger step increased recovery further but grade dropped slightly.
- Further work is needed to optimise primary and secondary grind sizes, which will be guided by mineralogical locking analysis data from planned QEMSCAN work.

4.1.2 Flotation

- Flotation of magnetic concentrate yielded some promising results for further consideration, although the concentrate produced for this work was of much lower grade and recovery than the initial sighter work.
- Of the reverse silica flotation tests, Wood recommends giving further consideration to Flotigam EDA and other diamine ether collectors for reverse flotation, such as Flotigam 2835-2 and the Lilaflot range, based on experience with other reverse flotation projects Wood is involved with.
- For direct RE flotation, Wood recommends continuing investigation into oleic acid and Aero 845, given their relatively lower costs compared with Aero 6493.
- Whilst Aero 6493 did achieve good upgrade and recovery, it is an expensive reagent, typically US\$12/kg, compared with Aero 845 at US\$2.80/kg and oleic acid at US\$2.10/kg (from Wood operating costs database). Supply security is also a concern as it is only made in one factory in Mexico on a twice yearly basis. It needs to be maintained at 15 deg C temperature with heaters to avoid its components separating out in cold weather, an issue for Arizona in winter months, adding to operating cost. It is interesting that the La Paz RE minerals respond to Aero 6493 as it has a very different composition to bastnaesite (a Ce/La fluorocarbonate mineral), and monazite (a Ce/La phosphate mineral).
- Other collectors, depressants and modified will also be investigated in the next program. Reagents tested limited to what SRC could access in the time available but there are other new generation fatty acid reagents that could also be effective with La Paz ore for direct flotation.
- As feldspars are the major gangue component, investigation into reverse flotation should also be evaluated. Traditionally, feldspar is floated under acidic conditions with fluorosilicic acid as collector, a toxic reagent, but new developments may offer safer and less onerous alternatives.

4.1.3 Other Strategies

- Work in this program has focussed on magnetic separation as a primary beneficiation method, as well as a pre-concentration step ahead of flotation.
- Further work to improve grade and recovery of the magnetic concentrate is needed ahead of upgrading with flotation in order to reduce unit reagent consumptions.
- No work has been undertaken on flotation as a primary separation method so far and is worth investigating to simplify the flowsheet.
- The locking of allanite at fine particle sizes, indicated in historical work, will remain the largest challenge for achieving high levels of upgrading.
- To provide a clear path forward for future work, comprehensive mineralogical analysis required to understand the deportment of RE minerals within the La Paz ore in order to determine how fineness of grind necessary to achieve liberation. From historical work, much of the value is locked below 25 microns, but the extent of fine grinding needs to be understood to determine how feasible it is to achieve significant upgrading, i.e. to 0.5 to 1% TREEs ahead of downstream processing.

4.2 Drill Core Testing Program

A testwork program has been developed and approved for execution by AREL, which commenced in early August at Nagrom Ltd in Western Australia, and is expecting to run for 3 to 4 months depending on outcomes and side investigations. 500 kg of diamond core selected by AREL from the 2021 drilling program has been delivered to Nagrom for testing. The key modules of work planned are as follows:

- Feed characterisation
 - Quantitative XRD to identify significant mineral types
 - Full head analysis
 - QEMSCAN with SEM – to investigate mineral associations and locking, with a view to identifying the optimum liberation size
 - Electron Micro Probe analysis (EMPA) – focussed scanning for REs within selected minerals in polished sections.
- Comminution
 - Bond ball mill work index
 - Bond abrasion index
 - SAG Media Competency (SMC) test
 - SAG Power Index (SPI) test
 - True ore SG with helium pycnometer.
- Magnetic separation
 - Davis Tube Recovery at various grind sizes to establish silica/feldspar release from magnetic minerals
 - LIMS beneficiation
 - WHIMS sighter and bulk testing to produce a feed stock for flotation work.

- Flotation
 - Further sighter reverse and direct flotation on un-beneficiated feed and magnetic concentrate
 - Bulk concentrate production with optimised beneficiation conditions.
- Concentrate treatment
 - Preliminary acid bake testing of bulk concentrate followed by water leaching
 - Testing of the proprietary Watts and Fisher process, which employs atmospheric leaching at elevated temperature of RE elements without the need for acid baking or autoclaves.

The outcomes of this program aim to provide the necessary information to enable a preliminary economic evaluation (PEA) for the project to be undertaken.



Attachment 1
SRC Testwork Report

REPORT

Concentration of TREE from Surface Chip Samples

Prepared for La Paz Rare Earth LLC.

By Lucia Xia Ph.D., P.ENG.
Saskatchewan Research Council
Mineral Processing

SRC Publication No. 15019-1C21

June 2021

REPORT

Concentration of TREE from Surface Chip Samples

Prepared for La Paz Rare Earth LLC.

By Lucia Xia Ph.D., P.ENG.
Saskatchewan Research Council
Mineral Processing

SRC Publication No. 15019-1C21

June 2021

Saskatchewan Research Council
125 – 15 Innovation Blvd.
Saskatoon, SK S7N 2X8
Tel: 306-385-4070
Email: lucia.xia@src.sk.ca

TABLE OF CONTENTS

TABLE OF CONTENTS..... I

LIST OF TABLES..... II

1. INTRODUCTION..... 1

2. SAMPLE PREPARATION AND CHARACTERIZATION 1

3. PRELIMINARY TREE CONCENTRATION..... 4

4. BULK CONCENTRATION OF TREE 8

5. PRELIMINARY FLOTATION..... 9

6. SUMMARY..... 10

Appendix-1: Sample Preparation of the Composite #1 (A 5 kg Sub-sample) 12

Appendix-2: X-ray Diffraction Analysis Report 12

Appendix-3: Flotation Testing Record and Results F#1-#4 12

Appendix-4: Flotation Testing Record and Results F#5-#8 12

Appendix-5: A Summary of Preliminary Flotation 12

LIST OF TABLES

Table 1 The Surface Chip Samples from La Paz REE Deposit	1
Table 2 Major Elements in the Chips Composite	3
Table 3 Minor Elements in the Chips Composite	3
Table 4 REE Content of the Chips Composite	3
Table 5 Results of XRD Analysis	4
Table 6 Results of PSD Analysis	4
Table 7 (1) Results of Preliminary Magnetic Separation (TREE)	6
Table 7 (2) Results of Preliminary Magnetic Separation (Fe ₂ O ₃)	6
Table 8 Results of Wet Magnetic Separation	8
Table 9 A New Sub-sample of Surface Chip Samples	8
Table 10 Results of WHIMS Testing for the New Sub-sample	9
Table 11 A Summary of Preliminary Rougher Flotation	10
Table 12 Calculation of Two Rougher Flotation	10
Table 13 A 5 kg Sub-sample including MET 01-32	13
Table 14 Results of Flotation F#1	17
Table 15 Results of Flotation F#2	17
Table 16 Results of Flotation F#3	18
Table 17 Results of Flotation F#4	18
Table 18 Results of Flotation F#5	22
Table 19 Back Calculation of F#5	23
Table 20 Results of Flotation F#6	23
Table 21 Results of Flotation F#7	24
Table 22 Results of Flotation F#8	25
Table 23 A Summary of Preliminary Flotation	26

1. INTRODUCTION

The Saskatchewan Research Council (SRC) has completed a preliminary testing program for the concentration of TREE from surface chips. The chip samples were provided by La Paz Rare Earth LLC. The metallurgical tests included:

- Sample preparation and analysis
- Diagnostic magnetic separation
- High intensity and low intensity wet magnetic separation
- Process ~30 kg bulk sample by WHIMS
- Perform eight rougher flotation tests

The following sections summarize the details of sample preparation, conditions of each test, and the results.

2. SAMPLE PREPARATION AND CHARACTERIZATION

2.1 Surface Chips Reception

72 kg of surface chip samples were received by SRC in four pails and in separate bags. A sample list is shown in Table 1 and several pictures of the REE chips are shown in Figure 1. It has been indicated that the surface chip samples of MET 01-32 were from the main zone of the orebody.

Table 1 The Surface Chip Samples from La Paz REE Deposit

Sample ID	Pail No.	Weight, g	Sample ID	Pail No.	Weight, g
MET -01	#1	2432.0	MET -17	#3	2292.5
MET -02		1889.5	MET -18		2030.5
MET -03		2451.0	MET -19		2167.5
MET -04		2294.0	MET -20		2644.0
MET -05		2021.5	MET -21		2308.0
MET -06		1809.5	MET -22		1967.5
MET -07		2125.5	MET -23		2086.5
MET -08		2198.0	MET -24		2496.0
MET -09	#2	2405.0	MET -25	#4	3300.5
MET -10		2774.5	MET -26		2103.5
MET -11		2045.5	MET -27		2376.0
MET -12		2186.5	MET -28		2417.5
MET -13		2129.0	MET -29		2441.5
MET -14		2160.0	MET -30		2586.0
MET -15		1873.0	MET -31		2207.5
MET -16		2157.0	MET -32		2034.5



Figure 1 Selected Pictures of the Surface Chip Samples

2.2 A Sub-sample for Head Analysis

After consultation with the client, it was decided that all of the samples of MET 01-32 from the main zone of the orebody were to be used as the head material for metallurgical testing. It is noted that these are surface samples and are not necessarily representative of ore at depth.

A 5 kg sub-sample was taken from the samples of MET 01-32. The weight percentage of each chip sample was strictly followed; thus the 5 kg sub-sample can be seamed as a representative of the composite of MET 01 to MET 32. The details of sample preparation are not listed here but can be found in Appendix 1.

The 5 kg sub-sample was primarily crushed to -2.0 mm and further dry ground to all passing No. 100 mesh (< 150 microns). 200 g mill discharge was taken by a raffle splitter for head analysis and the remaining was kept for subsequent testing.

2.3 Head Analysis

Head analysis included major, minor and trace elements by ICP-MS; Sulphur and Sulphate by LECO. The major composition of the chips composite is shown in Table 2, the minor elements are shown in Table 3 and the REE content is shown in Table 4.

LECO analysis indicated that the total sulphur and the sulphur in sulfate are <0.01% (wt). The TREE content of the sub-sample is 552 ppm, the Sc grade is 15 ppm.

Table 2 Major Elements in the Chips Composite

Element	SiO ₂	CaO	Al ₂ O ₃	Fe ₂ O ₃	TiO ₂	MgO	K ₂ O	MnO	Na ₂ O
Wt.%	59.9	4.63	16.6	7.05	1.13	1.78	3.59	0.11	2.66

Table 3 Minor Elements in the Chips Composite

Element	Cr	Sc	Ba	Y	Zr	Sr	V
ppm	69	15	1410	51	591	498	225

Table 4 REE Content of the Chips Composite

Assayed: REE		Calculated: REO		
	ppm		Conversion Factor	ppm
Ce	201	CeO ₂	1.2284	246.9
Dy	9.2	Dy ₂ O ₃	1.1477	10.6
Er	6.8	Er ₂ O ₃	1.1435	7.8
Eu	4.93	Eu ₂ O ₃	1.1579	5.7
Gd	19.6	Gd ₂ O ₃	1.1526	22.6
Ho	1.96	Ho ₂ O ₃	1.1455	2.2
La	98	La ₂ O ₃	1.1728	114.9
Lu	0.64	Lu ₂ O ₃	1.1372	0.7
Nb	32	Nb ₂ O ₅	1.4305	45.8
Nd	103	Nd ₂ O ₃	1.1664	120.1
Pr	26	Pr ₆ O ₁₁	1.2082	31.4
Sm	20.4	Sm ₂ O ₃	1.1596	23.7
Tb	2.08	Tb ₄ O ₇	1.1762	2.4
Th	17.4	ThO ₂	1.1379	19.8
Tm	0.6	Tm ₂ O ₃	1.1421	0.7
U	6.14	U ₃ O ₈	1.1792	7.2
Y	53.1	Y ₂ O ₃	1.2699	67.4
Yb	4.56	Yb ₂ O ₃	1.1387	5.2
LREE	448	LREO		537
HREE	103	HREO		125
TREE	552	TREO		662

2.4 XRD Analysis

The X-Ray diffraction analysis was used to determine the mineral composition of the chips composite. The report can be found in Appendix 2. Table 5 below summarizes the observations from XRD analysis. The presence of allanite cannot be confirmed due to the low concentration of REE. While, there is clinozoisite which is a member of the epidote group and may contain small amounts of REE.

Table 5 Results of XRD Analysis

Mineral Phases		Source	Wt. %
Albite	(AlSi ₃)NaO ₈	PDF#98-090-0656	32.5
Quartz	SiO ₂	PDF#98-091-4776	27.0
Biotite	FeMg ₂ K (AlSi ₃) O ₁₂ H ₂	PDF#98-090-2555	13.8
Anorthite	CaSi AlO ₄	PDF#98-090-0971	10.8
Clinozoisite	Ca ₂ Si ₃ Al _{2.79} Fe _{0.21} O ₁₃ H	PDF#98-090-4272	9.0
Chamosite	(Mg _{2.518} Fe _{2.482}) Al _{1.2} Si _{3.8} O ₁₈ H ₁₀	PDF#98-090-3835	7.0

* two-theta range of 5.0-70.1 deg.

2.5 PSD Analysis

The particle size distribution (PSD) analysis was performed to investigate REE distribution in different size fractions. 1 kg of the prepared sub-sample was placed on a set of sieves. The oversize and undersize were collected, dried, weighed, and assayed. The results of PSD analysis are shown in Table 6.

Table 6 Results of PSD Analysis

Sizes		Weight		Chemical composition, ppm					
Mesh	Microns	g	%	LREE	HREE	TREE	Sc	Fe ₂ O ₃ , Wt.%	SiO ₂ , Wt.%
140	106-150	152.4	15.5	327.0	67.9	394.9	13	5.3	64.9
200	75-106	73.0	7.4	409.7	90.8	500.5	14	5.8	64.0
400	38-75	129.2	13.2	482.8	100.8	583.6	15	6.4	63.1
500	25-38	75.6	7.7	450.7	104.4	555.1	18	6.5	62.0
<500	<25	551.0	56.2	338.7	96.8	435.5	17	8.1	57.5
Total Calculated		981.2	100.0	369.8	93.0	462.8	16	16	60.2

3. PRELIMINARY TREE CONCENTRATION

3.1 Preliminary Magnetic Separation

A diagnostic magnetic separation testing was performed for the prepared sub-sample. A laboratory dry magnetic separator (Frantz, as shown in Figure 2) was used and operated over a wide range of magnetic

field strength by adjusting the current. It aimed to determine if magnetic separation can be used to concentrate TREE, and how to achieve the best recovery of TREE.



Figure 2 A Laboratory Magnetic Separator (Frantz)

When the sample was placed on the chute, any particle having a good response to the magnetic force was separated away. The magnetics and non-magnetics were the two products from testing. The particle size of material tested has some impact on the separation, so the prepared sub-sample was classified into four size fractions, and diagnostic magnetic separation tests were performed for four size fractions individually.

The results are shown in Table 7 (1) and Table 7 (2). It can be seen that the ore was initially separated in a low intensity field where the magnetics were mostly iron oxides carrying a certain amount of TREE. The grade of Fe_2O_3 significantly increased, and mass pull of the magnetics decreased with the finer particle size fraction. This indicates iron oxides are fine-grained.

The non-magnetics product from the low intensity separation was further processed under medium intensity, where TREE minerals achieved significant upgrade. The grade of TREE was increased from ~500 ppm to 1700 ppm, and the recovery was ~50%.

The non-magnetics from medium intensity separation was separated in a high intensity field. After three stages magnetic concentration, the non-magnetics rejected only contained 100-150 ppm of TREE; the magnetics contained REE rich minerals. Approximately 80% of TREE was recovered.

Table 7 (1) Results of Preliminary Magnetic Separation (TREE)

Test ID	Size	Parameters		Magnetics				Non-Magnetics	
	Microns	Voltage	Current	Mass, g	Mass%	TREE (ppm)	%Dist.	TREE (ppm)	%Dist.
PMS-1	106-150	19.2	0.3	2.04	22.0	778.3	59.7		
		38.9	0.6	1.46	15.7	298.3	16.4		
		65.3	1.0	1.47	15.8	113.3	6.3	108.5	17.6
PMS-2	75-106	6.7	0.1	0.98	10.3	1063.1	21.3		
		33.4	0.5	2.38	25.0	1112.1	54.0		
		66.7	1.0	1.94	20.4	321.1	12.7	140.0	12.1
PMS-3	38-75	6.6	0.1	0.45	4.8	1243.1	10.0		
		33.2	0.5	1.82	19.3	1668.8	54.5		
		66.3	1.0	1.58	16.7	651.4	18.5	169.4	17.0
PMS-4	25-38	6.4	0.1	0.21	2.2	816.1	3.5		
		31.9	0.5	1.39	14.7	1708.4	48.8		
		65	1.0	1.48	15.7	898.3	27.3	156.3	20.4

Table 7 (2) Results of Preliminary Magnetic Separation (Fe₂O₃)

Test ID	Size	Parameters		Magnetics				Non-Magnetics	
	Microns	Voltage	Current	Mass, g	Mass%	Fe ₂ O ₃ (Wt.%)	%Dist.	Fe ₂ O ₃ (Wt.%)	%Dist.
PMS-1	106-150	19.2	0.3	2.04	22.0	8.37	44.1		
		38.9	0.6	1.46	15.7	8.58	32.4		
		65.3	1.0	1.47	15.8	3.73	14.2	0.8	9.4
PMS-2	75-106	6.7	0.1	0.98	10.3	12.4	26.5		
		33.4	0.5	2.38	25.0	10.3	53.5		
		66.7	1.0	1.94	20.4	3.44	14.6	0.6	5.4
PMS-3	38-75	6.6	0.1	0.45	4.8	15.4	15.2		
		33.2	0.5	1.82	19.3	13.2	52.8		
		66.3	1.0	1.58	16.7	5.96	20.7	0.9	11.2
PMS-4	25-38	6.4	0.1	0.21	2.2	18.6	9.5		
		31.9	0.5	1.39	14.7	13.7	46.1		
		65	1.0	1.48	15.7	8.08	28.9	1.0	15.5

3.2 Preliminary Wet Magnetic Separation

The preceding discussion of magnetic separation response indicates the REE rich minerals either associate with iron oxides or have good response to magnetic force under medium or high intensity and literatures indicated allanite is paramagnetic and should response to WHIMS treatment. TREE can be concentrated by magnetic separation. Furthermore, the prepared sub-sample is fine-grained, that the size fractions of 25-38 μm and 38-75 μm had a higher grade of TREE.

Wet magnetic separation was performed using a Eriez separator with electromagnet as shown in Figure 3. It was operated under low intensity 1000 Gs and high intensity 10000 Gs magnetic fields.

- 1.8 kg the prepared sub-sample was ground in a rod mill at 50% solids to P80 of 75 μm .
- Wet low intensity magnetic separation (WLIMS) was performed.
- The non-mag from WLIMS was separated under high intensity.
- The magnetics from WHIMS were ground at 50% solids to get P80 of 38 μm .

After re-grinding, it was separated under high intensity (WHIMS). Two passes were performed at 20% solids and 10% solids to minimize entrainment. 105 g magnetics as final products were collected.

The results of wet magnetic separation under low intensity and high intensity, with or without re-grinding, are shown in Table 8.

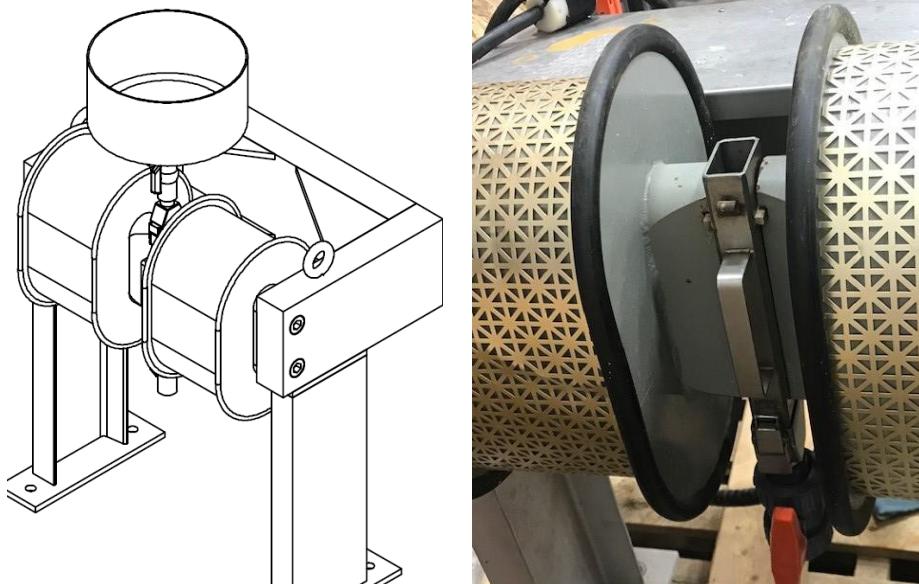

Figure 3 Eriez Magnetic Separator for Wet Mag-separation

Table 8 Results of Wet Magnetic Separation

Size	Intensity	Magnetics						Non-Magnetics			
P ₈₀ , um	Gs	Mass, g	Mass %	TREE ppm	%Dist	Fe ₂ O ₃ Wt.%	%Dist	TREE ppm	%Dist	Fe ₂ O ₃ Wt.%	%Dist
75	1000	72.0	4.0	912.3	6.1	22.8	13.8				
	10 k	336.0	18.7	1913.9	59.8	12.2	34.8	267.3	34.2	4.4	51.3
38	10 k	105.4	10.3	2559.5	25.7	21.7	19.9	1607.2	34.0	7.7	14.9

The results of wet magnetic separation show that TREE can be upgraded to 2560 ppm with re-grinding and magnetic cleaning, but the recovery dropped to 25.7%. Although WLIMS was operated under 1000 Gs field strength, there was still 6% of TREE along with iron oxides. From the preliminary wet magnetic separation, the TREE concentration strategy for a ~30 kg bulk sample was set as:

- Wet magnetic separation would be operated under 10000 Gs field strength.
- Re-grinding and cleaning of magnetics from WHIMS would not be included.

4. BULK CONCENTRATION OF TREE

4.1 A New Sub-sample

A 35 kg new sub-sample was prepared from MET 01 to MET 32. The weight percentage of each surface chip sample was followed as for the previous 5 kg sub-sample; this new sub-sample can also be deemed as representative of the composite of MET 01 to MET 32. The details of sample preparation are listed in Table 9.

Table 9 A New Sub-sample of Surface Chip Samples

Sample ID	Available Mass		Composite Mass	Sample ID	Available Mass		Composite Mass
	g	%	g		g	%	g
MET -01	2432	3.4	1175.5	MET-17	2292.5	3.2	1108.1
MET -02	1889.5	2.6	913.3	MET-18	2030.5	2.8	981.4
MET -03	2451	3.4	1184.7	MET-19	2167.5	3.0	1047.7
MET -04	2294	3.2	1108.8	MET-20	2644	3.7	1278.0
MET -05	2021.5	2.8	977.1	MET-21	2308	3.2	1115.6
MET -06	1809.5	2.5	874.6	MET-22	1967.5	2.7	951.0
MET -07	2125.5	2.9	1027.4	MET-23	2086.5	2.9	1008.5
MET -08	2198	3.0	1062.4	MET-24	2496	3.4	1206.4
MET-09	2405	3.3	1162.5	MET-25	3300.5	4.6	1595.3
MET-10	2774.5	3.8	1341.1	MET-26	2103.5	2.9	1016.7
MET-11	2045.5	2.8	988.7	MET-27	2376	3.3	1148.4
MET-12	2186.5	3.0	1056.8	MET-28	2417.5	3.3	1168.5

Table 9 A New Sub-sample of Surface Chip Samples (Continued)

Sample ID	Available Mass		Composite	Sample ID	Available Mass		Composite
	g	%	g		g	%	g
MET-13	2129	2.9	1029.1	MET-29	2441.5	3.4	1180.1
MET-14	2160	3.0	1044.0	MET-30	2586	3.6	1249.9
MET-15	1873	2.6	905.3	MET-31	2207.5	3.0	1067.0
MET-16	2157	3.0	1042.6	MET-32	2034.5	2.8	983.4

4.2 Bulk WHIMS

The new sub-sample was stage crushed to -2.0 mm and homogenized. The crusher discharge was split to 1 kg test charges and wet ground by a rod mill at 60% pulp density to P_{80} of 75 μm . The first two grinding discharge was screened to correct grinding parameters and ensure the mill discharge with a size of P_{80} of 75 μm . Therefore, 33 kg was carrying forward to WHIMS processing. The results of WHIMS processing are shown in Table 10.

5.5 kg of WHIMS concentrates were produced with a REE grade of 1279 ppm. The concentrate was used for subsequent preliminary flotation, where the ICP-whole rock assay was performed. The assays of Sc, Fe_2O_3 , SiO_2 , etc. were shown in section 5.

Table 10 Results of WHIMS Testing for the New Sub-sample

New Sub-sample	Mass		Assay, ppm	
	kg	%	TREE	TREO
WHIMS mag	5.5	16.7	1279.4	1535.3
WHIMS non-mag	27.5	83.3	n/a	n/a
Calculated Total	33.0	100.0	n/a	n/a

5. PRELIMINARY FLOTATION

Several flotation regimes were tried out using different collectors. The detailed record and results had been provided in a separate spreadsheet and also can be found in Appendix 3, 4 and 5. Table 11 shows a summary of all of the rougher flotation tests.

Seen from Table 11, it is noted that grinding to P_{80} of 38 microns is required to concentrate REE rich minerals. F#5 to F#8 adopted a fine 38 microns P_{80} , so the separation of TREE against gangue minerals was seen to be improved. The grade and distribution of SiO_2 is not shown here but can be found in the spreadsheet (Appendix 3 and 4).

Table 11 A Summary of Preliminary Rougher Flotation

Test ID	P80	Collector	pH	Mass pull of Ro. Conc. %	Grade of Ro. Conc, ppm	Recovery of Ro. Conc. %
	Microns				TREE	TREE
F#1	75	Armac	9.0	18.8	1082.2	14.4
F#2	75	Flotigam EDA	9.0	57.8	1159.3	53.2
F#3	63	Flotigam 4343	7.4	21.4	1211.3	21.5
F#4	63	A3030	7.0	51.9	1037.2	49.1
F#5	38	Flotigam EDA	9.0	59.7	726.3	40.6
F#6	38	OA	9.0	45.1	1576.2	70.6
F#7	38	A845	8.0	71.5	1295.3	86.8
F#8	38	A6493	9.0	47.4	1490.5	68.1

Rougher flotation of F#5 adopted reverse silica flotation. The silicates were collected as froth, and REE rich minerals reported to sinks. When back calculated, the REE product in the sink takes 40.3% of total weight and carries 59.4% of TREE. The grade of sinks is 1580 ppm TREE, as shown in Table 12. The details can be found in Appendix 4.

Rougher flotation of F#7 had 6 rougher concentrates that were collected at different times. The TREE grade of R5 and R6 dropped to ~800 ppm. If the rougher flotation stopped at R4, the REE recovery was slightly lower but provided a higher grade of TREE. The calculation can be found in the spreadsheet (Appendix 4), the results are also shown in Table 12.

Table 12 Calculation of Two Rougher Flotation

Test ID	Mass pull of REE rich products, %	Grade of REE rich products, ppm	Recovery of REE rich products. %	Back Calculated
		TREE	TREE	
F#5	40.3	1579.5	59.4	Sinks
F#7	46.8	1526.9	67.0	Ro Conc=R1-R4

Test F#5 results show Flotigam EDA silica collector can provide good reverse flotation with 59.4% of TREE left off in sink. Collectors oleic acid (OA), A845 and A6493 all promoted the direct flotation of TREE. The TREE grade is at round 1500 ppm with a recovery of 67-70%. OA and A845 are much more economical than A6493 and deserve further attention.

6. SUMMARY

The surface chip composite from the main zone of La Paz deposit with a rare earth content of 552 ppm TREE were prepared by SRC Mineral Processing and subjected to a preliminary TREE concentration.

- It was found that TREE concentration can be achieved by wet magnetic separation under high intensity fields. Grinding to P₈₀ of 75 microns is required for primary separation, but re-grinding at a finer P₈₀ size of 38 microns is required to achieve a significant upgrade.
- Preliminary froth flotation has been done. Reverse flotation using amine collector can achieve ~60% TREE recovery and direct flotation using OA or Aero collectors can bring the recovery to 67-70%. Grinding to P₈₀ of 38 microns is required to achieve this upgrade. Finer grind will be needed to achieve higher REE grades.

Appendix-1: Sample Preparation of the Composite #1 (A 5 kg Sub-sample)

Appendix-2: X-ray Diffraction Analysis Report

Appendix-3: Flotation Testing Record and Results F#1-#4

Appendix-4: Flotation Testing Record and Results F#5-#8

Appendix-5: A Summary of Preliminary Flotation

Appendix-1: Sample Preparation of the Composite #1 (A 5 kg Sub-sample)**Table 13 A 5 kg Sub-sample including MET 01-32**

#	Sample ID	Available Mass		Composite Mass
		g	%	g
1	MET -01	2432	3.4	167.9
2	MET -02	1889.5	2.6	130.5
3	MET -03	2451	3.4	169.2
4	MET -04	2294	3.2	158.4
5	MET -05	2021.5	2.8	139.6
6	MET -06	1809.5	2.5	124.9
7	MET -07	2125.5	2.9	146.8
8	MET -08	2198	3.0	151.8
9	MET-09	2405	3.3	166.1
10	MET-10	2774.5	3.8	191.6
11	MET-11	2045.5	2.8	141.2
12	MET-12	2186.5	3.0	151.0
13	MET-13	2129	2.9	147.0
14	MET-14	2160	3.0	149.1
15	MET-15	1873	2.6	129.3
16	MET-16	2157	3.0	148.9
17	MET-17	2292.5	3.2	158.3
18	MET-18	2030.5	2.8	140.2
19	MET-19	2167.5	3.0	149.7
20	MET-20	2644	3.7	182.6
21	MET-21	2308	3.2	159.4
22	MET-22	1967.5	2.7	135.9
23	MET-23	2086.5	2.9	144.1
24	MET-24	2496	3.4	172.3
25	MET-25	3300.5	4.6	227.9
26	MET-26	2103.5	2.9	145.2
27	MET-27	2376	3.3	164.1
28	MET-28	2417.5	3.3	166.9
29	MET-29	2441.5	3.4	168.6
30	MET-30	2586	3.6	178.6
31	MET-31	2207.5	3.0	152.4
32	MET-32	2034.5	2.8	140.5
Total		72411	100.0	5000.0

Appendix-2: X-ray Diffraction Analysis Report

Composite1

FILE: [Composite1.raw] Composite1*
 SCAN: 4.0/70.0537/0.01997/49.7(sec), Cu(40kV,40mA), I(p)=34421, 01/15/21 09:40a
 PROC: [WPF Control File]

- K-alpha2 Peak Present
- Allow Negative Isotropic B
- Allow Negative Occupancy
- Apply Anomalous Scattering
- [Diffractometer LP] Two-Theta Range of Fit = 5.0 - 70.1(deg)
- Specimen Displacement - Cos(Theta) = 0.048591(0.007373)
- Monochromator Correction for LP Factor = 1.0
- K-alpha2/K-alpha1 Intensity Ratio = 0.5

Profile Shape Function (PSF) for All Phases: Pearson-VII, Fixed-BG, Lambda=1.54059Å (Cu/K-alpha1)

Phase ID (6)	Source	I/Ic	Wt%	#L
■ Albite - (AlSi ₃)NaO ₈	PDF#98-090-0656	0.66(5%)	32.5 (2.7)	280
■ Quartz - SiO ₂	PDF#98-091-4776	4.52(5%)	27.0 (2.0)	18
■ Biotite - FeMg ₂ K(AlSi ₃)O ₁₂ H ₂	PDF#98-090-2555	1.44(5%)	13.8 (1.7)	110
■ Anorthite - CaSiAlO ₄	PDF#98-090-0971	0.64(5%)	10.8 (1.5)	515
■ Clinozoisite - Ca ₂ Si ₃ Al _{2.79} Fe _{0.21} O ₁₂ H	PDF#98-090-4272	0.85(5%)	9.0 (1.4)	231
■ Chamosite - (Mg _{2.518} Fe _{2.482})Al _{1.2} Si _{3.8} O ₁₈ H ₁₀	PDF#98-090-3835	1.44(5%)	7.0 (0.9)	276

NOTE: Fitting Halted at Iteration 20(4): R=10.02% [E=2.04%, R/E=4.92, P=54, EPS=0.5]

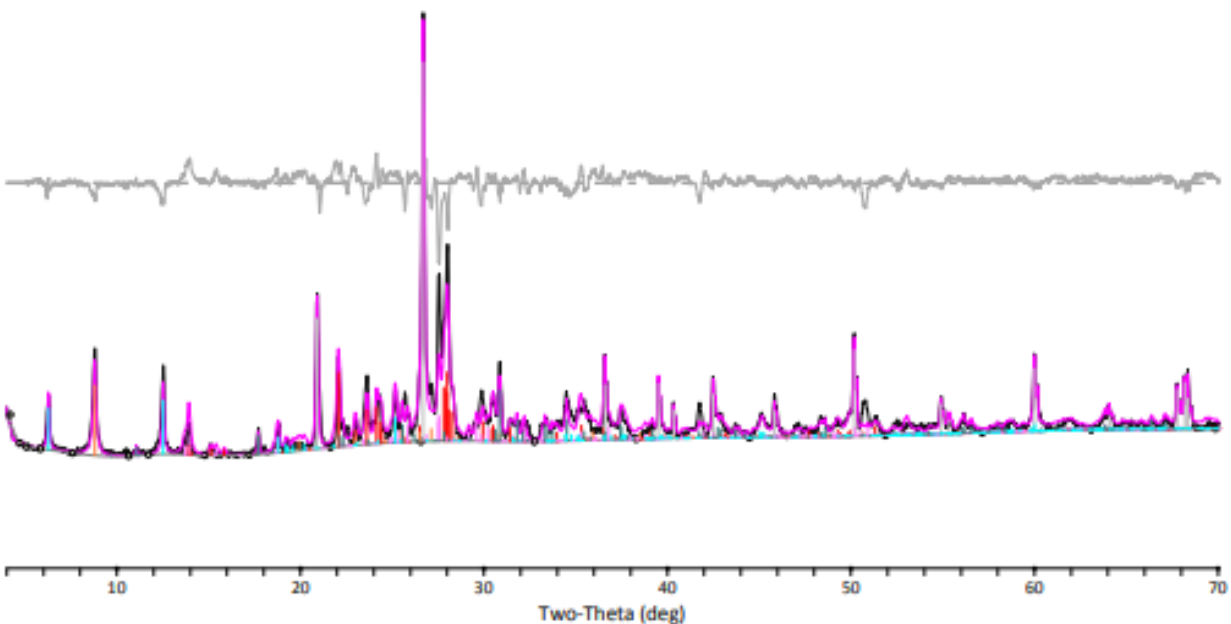
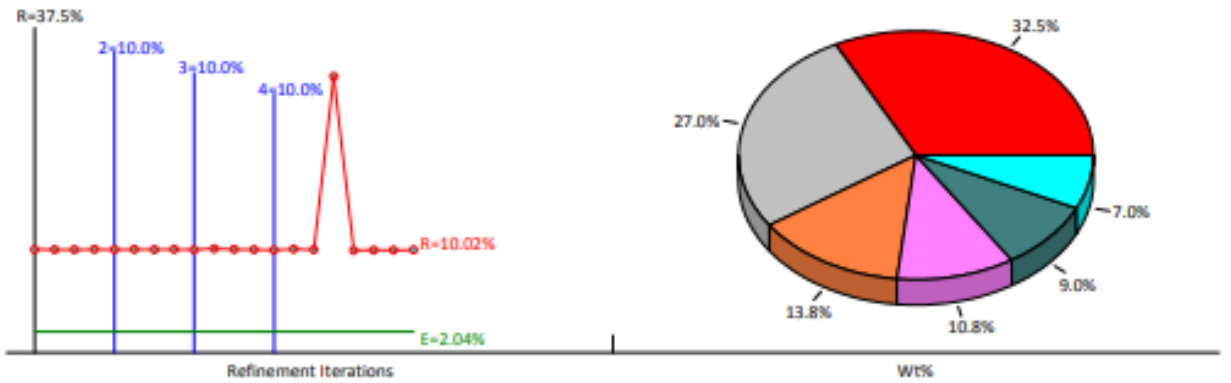

Appendix-3: Flotation Testing Record and Results F#1-#4



DATE: 29-Apr-21
OPERATOR: Lucia Xia

15019-La Paz REE Project
Reverse Flotation F#1 and F#2

Purpose: Preliminary Flotation using amine collectors
Procedure: 1. weigh 450 g ore
2. Grinding at 60% solids for 3.5 min to get a fresh surface
3. Proceed rougher flotation at 30-35% solids use a 1.5 L cell at pH 9
4. Investigate flotation kinetics by collecting the froth every one min for the first three minutes

Reagents of F#1

Reagents of F#1	Dosage, g/t	g per 450 g of	Solution	Usage
Modified Starch	1000	0.45	10%	4.5 g
Armac @cond 3	200	0.09	2%	4.5 g
Armac @cond 5	100	0.05	2%	2.25 g
Dowfroth @0'				1 droplet



Conditions of F#1

Operation	Time	Reagent	Pulp pH	ORP, R.mV
Conditioning 1	2		8.1	231
Conditioning 2	5	Starch	9.3 to 9.1	171
Conditioning 3	2	Armac T	8.9	170
Conditioning 4	1	Dowfroth	8.9	173
Float	2			
Conditioning 5	2	Armac T	8.9	170
Float	5			

Flotation Products of F#1

ID	Float, min	weight, g	Mass, %	Cum. mass%	TREE, ppm	TREE Distr. #	Cum Recovery, %
F#1-R1	1	13.9	3.1	3.1	992.10	2.2	2.2
F#1-R2	1	8.2	1.8	5.0	684.44	0.9	3.1
F#1-R3	1	16.9	3.8	8.7	976.83	2.6	5.7
F#1-R4	1	8	1.8	10.5	975.08	1.2	6.9
F#1-R5	3	37	8.3	18.8	1275.56	7.5	14.4
F#1-Tail		362.3	81.2	100.0	1490.22	85.6	
Total	7	446.3			1413.43		

Mass balance = 99.2%

Reagents of F#2

Reagents of F#2	Dosage, g/t	g per 450 g of	Solution	Usage
Modified Starch	1200	0.54	10%	5.4 g
Flotigam EDA	200	0.09	as is	3 droplet
Dowfroth				1 droplet



Conditions of F#2

Operation	Time	Reagent	Pulp pH	ORP, R.mV
Conditioning 1	2		8.2	166
Conditioning 2	5	Starch	9.6	165
Conditioning 3	2	Flotigam	9	75
Conditioning 4	1	Dowfroth	9.1	172
Float	5			

Flotation Products of F#2

ID	Float, min	weight, g	Mass, %	Cum. mass%	TREE, ppm	TREE Distr. #	Cum Recovery, %
F#2-R1	1	140.7	31.5	31.5	1195.09	29.8	29.8
F#2-R2	1	56.5	12.6	44.1	1127.84	11.3	41.2
F#2-R3	1	36.3	8.1	52.2	1093.76	7.0	48.2
F#2-R4	2	24.9	5.6	57.8	1123.88	5.0	53.2
F#2-Tail		188.8	42.2	100.0	1397.66	46.8	
Total	5	447.2			1259.92		

Mass balance = 99.4%

15019-La Paz REE Project
Flotation #3 and #4

Purpose:	Preliminary Flotation using amine collectors
Procedure:	1. weigh 450 g ore 2. Grinding at 60% solids for 5 min to get a fresh surface and cut the size

Reagents of F#3

Reagents of F#3	Dosage, g/t	g per 450 g or	Solution	Usage
Modified Starch	1000	0.45	10%	4.5 g
CMC	70	0.320	0.32%	10 g
Flotigam 4343 @0'	150	0.07		2 droplets
Flotigam 4343 @1'	150	0.07		2 droplets
Dowfroth @0'				1 droplet

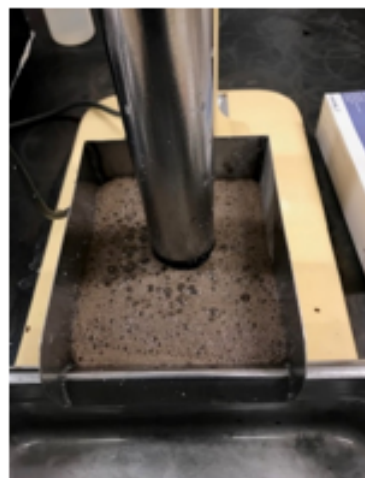
**Conditions of F#3**

Operation	Time	Reagent	Pulp pH	ORP, R.mV
Conditioning 1	2		8.1	188
Conditioning 2	5	Starch	8.28	155
Conditioning 3	2	CMC	8.58	142
Conditioning 4	1	HCl	7.35	173
Conditioning 5	2	F4343		
Conditioning 6	1	Frother		
Float	1			
Conditioning 7	1	F4343		
Float	4			

Flotation Products of F#3

ID	Float, min	weight, g	Mass, %	Cum. mass%	TREE, ppm	TREE Distr. %	Cum Recovery, %
F#3-R1	1	10.9	2.4	2.4	1304.53	2.6	2.6
F#3-R2	1	21.4	4.8	7.2	1247.72	4.9	7.5
F#3-R3	1	29.5	6.6	13.8	1183.92	6.4	14.0
F#3-R4	2	34.5	7.7	21.4	1182.57	7.5	21.5
F#3-Tail		352.8	78.6	100.0	1208.04	78.5	
Total	5	443.1	100.0		1208.73	100.0	

Mass blank = 99.8%

Reagents of F#4

Reagents of F#4	Dosage, g/t	g per 450 g or	Solution	Usage
Modified Starch	500	0.23	10%	2.3 g
Lead Acetate	500	0.23		0.23
Acro 3030	200	0.09	as is	3 droplets
Dowfroth				1 droplet

Conditions of F#4

Operation	Time	Reagent	Pulp pH	ORP, R.mV
Conditioning 1	2		8.18	190
Conditioning 2	5	Starch	8.9	170
Conditioning 3	2	Pb	6.6	210
Conditioning 4	2	A3030	7.05	213
Conditioning 5	1	Dowfroth	7.08	
Float	4			

Flotation Products of F#4

ID	Float, min	weight, g	Mass, %	Cum. mass%	TREE, ppm	TREE Distr. %	Cum Recovery, %
F#4-R1	1	105.1	23.4	23.4	1069.37	22.8	22.8
F#4-R2	1	83	18.5	41.9	1014.66	17.1	39.9
F#4-R3	1	27.3	6.1	48.0	981.39	5.4	45.3
F#4-R4	1	17.6	3.9	51.9	1038.16	3.7	49.1
F#4-Tail		215.7	48.1	100.0	1163.40	50.9	
Total	4	448.7			1097.87	100.0	

Mass blank = 99.7%

Table 14 Results of Flotation F#1

PRODUCT	WEIGHT		TREE		SiO2	
	Gram	%	ppm	%dist	%	%dist
F#1-R1	13.9	3.11	992.1	2.19	41.6	2.66
F#1-R2	8.2	1.84	684.44	0.89	41.5	1.57
F#1-R3	16.9	3.79	976.83	2.62	45.6	3.55
F#1-R4	8.0	1.79	975.08	1.24	46.2	1.70
F#1-R5	37.0	8.29	1275.56	7.48	48.1	8.20
Tails	362.3	81.2	1490.22	85.59	49.3	82.31
Calc'd Head	446.3	100.0	1413.4	100.00	48.6	100.00
Assay Head			1279.4			
F#1-R1	13.9	3.11	992.10	2.19	41.60	2.66
F#1-R1-2	22.1	4.95	877.95	3.08	41.56	4.23
F#1-R1-3	39.0	8.74	920.80	5.69	43.31	7.78
F#1-R1-4	47.0	10.5	930.04	6.93	43.80	9.49
F#1-R1-5	84.0	18.8	1082.23	14.4	45.70	17.7
F#1 feed	446.3	100.0	1413.43	100.0	48.62	100.0

Table 15 Results of Flotation F#2

PRODUCT	WEIGHT		TREE		SiO2	
	Gram	%	ppm	%dist	%	%dist
F#2-R1	140.7	31.5	1195.09	29.84	47.8	31.03
F#2-R2	56.5	12.6	1127.84	11.31	48.2	12.56
F#2-R3	36.3	8.1	1093.76	7.05	48	8.04
F#2-R4	24.9	5.6	1123.88	4.97	48.8	5.61
Tails	188.8	42.2	1397.66	46.83	49.1	42.77
Calc'd Head	447.2	100.0	1259.9	100.00	48.5	100.00
Assay Head			1279.4			
F#2-R1	140.7	31.5	1195.09	29.8	47.80	31.0
F#2-R1-2	197.2	44.1	1175.82	41.2	47.91	43.6
F#2-R1-3	233.5	52.2	1163.06	48.2	47.93	51.6
F#2-R1-4	258.4	57.8	1159.29	53.2	48.01	57.2
F#2 feed	447.2	100.0	1259.92	100.0	48.47	100.0

Table 16 Results of Flotation F#3

PRODUCT	WEIGHT		TREE		SiO2	
	Gram	%	ppm	%dist	%	%dist
F#3-R1	10.9	2.4	1304.53	2.62	47	2.36
F#3-R2	21.4	4.8	1247.72	4.92	46.4	4.58
F#3-R3	29.5	6.6	1183.92	6.43	47.6	6.47
F#3-R4	34.5	7.7	1182.57	7.52	47.5	7.55
Tails	352.8	78.6	1208.04	78.51	48.6	79.03
Calc'd Head	449.1	100.0	1208.7	100.00	48.3	100.00
Assay Head			1279.4			
F#3-R1	10.9	2.43	1304.53	2.62	47.00	2.36
F#3-R1-2	32.3	7.19	1266.89	7.54	46.60	6.94
F#3-R1-3	61.8	13.8	1227.29	14.0	47.08	13.4
F#3-R1-4	96.3	21.4	1211.27	21.5	47.23	21.0
F#3 feed	449.1	100.0	1208.73	100.0	48.31	100.0

Table 17 Results of Flotation F#4

PRODUCT	WEIGHT		TREE		SiO2	
	Gram	%	ppm	%dist	%	%dist
F#4-R1	105.1	23.4	1069	22.82	47.8	23.06
F#4-R2	83	18.5	1015	17.10	48.2	18.36
F#4-R3	27.3	6.1	981	5.44	48	6.02
F#4-R4	17.6	3.9	1038	3.71	48.8	3.94
Tails	215.7	48.1	1163	50.94	49.1	48.62
Calc'd Head	448.7	100.0	1097.9	100.00	48.6	100.00
Assay Head			1279.4			
F#4-R1	105.1	23.4	1069.37	22.8	47.80	23.1
F#4-R1-2	188.1	41.9	1045.23	39.9	47.98	41.4
F#4-R1-3	215.4	48.0	1037.14	45.3	47.98	47.4
F#4-R1-4	233.0	51.9	1037.22	49.1	48.04	51.4
F#4 feed	448.7	100.0	1097.87	100.0	48.55	100.0

Appendix-4: Flotation Testing Record and Results F#5-#8



DATE: 18-May-21
OPERATOR: Lucia Xia

15019-La Paz REE Project
Preliminary flotation-Test plan

Purpose:	Preliminary Flotation using various collectors
Procedure:	<ol style="list-style-type: none"> weigh 500 g ore Grinding at 60% solids for 5.5 min to get a size of P80=38 microns Proceed rougher flotation at 20% solids use a 2.5 L cell Investigate flotation kinetics by collecting the froth at different conditioning time

F#5: Grind to P80 of 38 micron, float at 20% pulp density (500 g ore in 2.5L cell) for 10 min.

Reagents of F#5	Dosage, g/t	g per 500 g ore	Solution	Usage
Modified Starch	1200	0.60	10%	6 g
Flotigam EDA	200	0.10	as is	3 droplets
Dowfroth				1 droplet

Pulp pH should be maintained at around 9.0; sampling every min.

F#6: Grind to P80 of 38 micron, conditioning at 20% pulp density (500 g ore in 2.5L cell)

Reagents of F#6	Dosage, g/t	g per 500 g ore	Solution	Usage
Sodium Silicate	300	0.15	10%	1.5 g
Modified starch	150	0.08	10%	0.8 g
OA	300	0.15	as is	5 droplets
Dowfroth				1 droplet

Pulp pH should be maintained at pH 9.0-9.5; slurry temperature >25C, Collect froth at 1, 2, 4, 8, 16, 32 min, froth time 1 min

F#7: Grind to P80 of 38 micron, conditioning at 20% pulp density (500 g ore in 2.5L cell)

Reagents of F#7	Dosage, g/t	g per 500 g ore	Solution	Usage
Sodium Silicate	300	0.15	10%	1.5 g
Modified starch	150	0.08	10%	0.8 g
A845	300	0.15		
Dowfroth				1 droplet

Pulp pH should be adjusted using HCl to pH 7-8; slurry temperature >25C, Collect froth at 1, 2, 4, 8, 16, 32 min, froth time 1 min

F#8: Grind to P80 of 38 micron, conditioning at 20% pulp density (500 g ore in 2.5L cell)

Reagents of F#7	Dosage, g/t	g per 500 g ore	Solution	Usage
Sodium Silicate	300	0.15	10%	1.5 g
Modified starch	150	0.08	10%	0.8 g
Lead Nitrate	500	0.25	as is	0.25 g
A 6493	500	0.25		
Dowfroth				1 droplet

Pulp pH should be maintained at pH 9; slurry temperature > 40C, Collect froth at 1, 2, 4, 8, 16, 32 min, froth time 1 min



DATE: 20-May-21
OPERATOR: Lucia Xia

15019-La Paz REE Project
Rougher Flotation F#5 and F#6

Purpose:	Rougher Flotation Tests according to the plan
Procedure:	<ol style="list-style-type: none"> weigh 500 g ore Grinding at 60% solids for 12 min to P80 of 38 um Proceed rougher flotation using a 2.5 L cell Staged addition of collectors

Reagents of F#5

Reagents of F#5	Dosage, g/t	g per 500 g ore	Solution	Usage
Modified Starch	1200	0.60	10%	6.0 g
Flotigam EDA @cond 3	65	0.03	As is	1 droplet
Flotigam EDA @cond 5	65	0.03	As is	1 droplet
Flotigam EDA @cond 6	65	0.03	As is	1 droplet
Dowfroth @ cond 4			As is	1 droplet

Conditions of F#5

Operation	Time	Temp, °C	Reagent	Pulp pH	ORP, R.mV
Conditioning 1	2	26.8		8.1	225
Conditioning 2	5		Starch	9	181
Conditioning 3	2		Flotigam EDA	8.85	
Conditioning 4	1		Dowfroth	8.9	
Float R1, R2, R3	3				
Conditioning 5	1		Flotigam EDA	8.85	
Float R4, R5, R6	3				
Conditioning 6	1		Flotigam EDA	8.85	
Float R7, R8, R9	3				

Reagents of F#6

Reagents of F#6	Dosage, g/t	g per 500 g ore	Solution	Usage
Na ₂ SiO ₄	300	0.15	10%	1.5 g
Modified Starch	150	0.08	10%	0.8 g
OA @ cond 3	150	0.08	as is	3 droplets
Dowfroth			as is	1 droplet
OA @ cond 5	150	0.07	as is	2 droplets
Na ₂ SiO ₄ @ cond 6	300	0.15	10%	1.5 g
Starch @cond 6	150	0.08	10%	0.8 g
OA @ cond 6	150	0.07	as is	2 droplets

Conditions of F#6

Operation	Time	Reagent	Pulp pH	ORP, R.mV
Conditioning 1	2		8.32	210
Conditioning 2	5	Na ₂ SiO ₄ /Starch	9.96	265
Conditioning 3	1	HCl	9	320
Conditioning 3	2	OA	9	320
Conditioning 4	1	Dowfroth	9.1	
Float R1	1			
Conditioning 5	1	OA	8.8	
Float R2, R3, R4				
Conditioning 6	1	Na ₂ SiO ₄ /starch/HCl/	9.8/9.1	
Float R5, R6				



15019-La Paz REE Project
Rougher Flotation F#7 and F#8

Purpose: Rougher Flotation Tests according to the plan
Procedure:
 1. weigh 500 g ore
 2. Grinding at 60% solids for 12 min to P80 of 38 um
 3. Proceed rougher flotation using a 2.5 L cell
 4. Staged addition of the collectors

Reagents of F#7

Reagents of F#7	Dosage, g/t	g per 500 g ore	Solution	Usage
Na ₂ SiO ₄	300	0.15	10%	1.5 g
Modified Starch	150	0.08	10%	0.8 g
A845	300	0.15	15%	1.0 g
Dowfroth			As is	1 droplet

Conditions of F#7

Operation	Time	Temp, °C	Reagent	Pulp pH	ORP, R.mV
Conditioning 1	2	25.5	Na ₂ SiO ₄	8.62	137
Conditioning 2	1		Starch	9.96	120
Conditioning 3	1		HCl	7.95	154
Conditioning 4	1		A845/dowfroth	8.05	
Float R1, R2, R3, R4	3				
Conditioning 5	1		A845	8.1	
Float R5, R6	3				

Reagents of F#8

Reagents of F#8	Dosage, g/t	g per 500 g ore	Solution	Usage
Na ₂ SiO ₄	300	0.15	10%	1.5 g
Modified Starch	150	0.08	10%	0.8 g
Lead Nitrate	500	0.25	as is	0.25 g
A 6493	500	0.25	as is	8 droplets
Dowfroth			As is	1 droplet

Conditions of F#8

Operation	Time	Reagent	Pulp pH	ORP, R.mV
Conditioning 1	2	Na ₂ SiO ₄	8.43	271
Conditioning 2	1	Starch	10.16	229
Conditioning 3	1	Lead Nitrate	9.05	206
Conditioning 3	2	A6493	9.05	205
Conditioning 4	1	Dowfroth		
Float R1, R2, R3				
Conditioning 5	2	A6493		
Float R4, R5				
Conditioning 6	1	A6493		
Float R6				

Table 18 Results of Flotation F#5

PRODUCT	WEIGHT		TREE		SiO ₂	
	Gram	%	ppm	%dist	%	%dist
F#5-R1	45.8	9.56	584.40	5.22	49.4	10.18
F#5-R2	27.2	5.68	481.50	2.56	50	6.12
F#5-R3	12.2	2.55	412.83	0.98	49.5	2.72
F#5-R4	53.0	11.1	743.98	7.70	52.6	12.54
F#5-R5	50.7	10.6	746.61	7.39	52.4	11.95
F#5-R6	30.5	6.37	708.77	4.22	52.2	7.16
F#5-R7	31.8	6.64	956.83	5.94	51.3	7.34
F#5-R8	20.4	4.26	978.65	3.90	51.2	4.70
F#5-R9	14.5	3.03	938.8	2.66	50.3	3.28
Tails	192.8	40.3	1579.5	59.44	39.2	34.00
Calc'd Head	478.9	100.0	1069.8	100.00	46.41	100.00
Assay Head			1279.4		48.47	
F#5-R1	45.8	9.56	584.40	5.22	49.40	10.2
F#5-R1-2	73.0	15.2	546.06	7.78	49.62	16.3
F#5-R1-3	85.2	17.8	526.98	8.76	49.61	19.0
F#5-R1-4	138.2	28.9	610.20	16.5	50.75	31.6
F#5-R1-5	188.9	39.4	646.81	23.8	51.20	43.5
F#5-R1-6	219.4	45.8	655.43	28.1	51.34	50.7
F#5-R1-7	251.2	52.5	693.58	34.0	51.33	58.0
F#5-R1-8	271.6	56.7	714.99	37.9	51.32	62.7
F#5-R1-9	286.1	59.7	726.34	40.6	51.27	66.0
F#5 feed	478.9	100.0	1069.81	100.0	46.41	100.0
Mass blance =	95.8%					
This sample was screened to check P ₈₀						

Table 19 Back Calculation of F#5

PRODUCT	Calculated Rougher Conc				Calculated REE in sink		
	Mass. gr	Mass, %	TREE, ppm	Cum Distr.%	Mass	Distribution, %	Grade of TREE
F#5-R1	45.8	9.6	584.4	5.2	90.4	94.8	1121.1
F#5-R1-2	73.0	15.2	546.1	7.8	84.8	92.2	1164.0
F#5-R1-3	85.2	17.8	527.0	8.8	82.2	91.2	1187.3
F#5-R1-4	138.2	28.9	610.2	16.5	71.1	83.5	1256.2
F#5-R1-5	188.9	39.4	646.8	23.8	60.6	76.2	1345.3
F#5-R1-6	219.4	45.8	655.4	28.1	54.2	71.9	1420.2
F#5-R1-7	251.2	52.5	693.6	34.0	47.5	66.0	1484.9
F#5-R1-8	271.6	56.7	715.0	37.9	43.3	62.1	1534.7
F#5-R1-9	286.1	59.7	726.3	40.6	40.3	59.4	1579.5
F#5 feed	478.9	100.0	1069.8	100.0			

Table 20 Results of Flotation F#6

PRODUCT	WEIGHT		TREE		SiO2	
	Gram	%	ppm	%dist	%	%dist
F#6-R1	31.8	6.37	1724.76	10.93	39.5	5.22
F#6-R2	55.5	11.1	1479.82	16.37	44.1	10.18
F#6-R3	45.4	9.10	1762.60	15.95	41.6	7.85
F#6-R4	26.4	5.29	1143.96	6.02	46.9	5.15
F#6-R5	21.8	4.37	1758.78	7.64	42.5	3.85
F#6-R6	43.9	8.80	1566.76	13.71	45.7	8.34
Tails	274.2	54.9	537.3	29.37	52.1	59.40
Calc'd Head	499.0	100.0	1005.3	100.00	48.19	100.00
Assay Head			1279.4		48.62	
F#6-R1	31.8	6.37	1724.76	10.9	39.50	5.22
F#6-R1-2	87.3	17.5	1569.04	27.3	42.42	15.4
F#6-R1-3	132.7	26.6	1635.26	43.3	42.14	23.3
F#6-R1-4	159.1	31.9	1553.74	49.3	42.93	28.4
F#6-R1-5	180.9	36.3	1578.45	56.9	42.88	32.3
F#6-R1-6	224.8	45.1	1576.17	70.6	43.43	40.6
F#6 feed	499.0	100.0	1005.32	100.0	48.19	100.0

Table 21 Results of Flotation F#7

PRODUCT	WEIGHT		TREE		SiO2	
	Gram	%	ppm	%dist	%	%dist
F#7-R1	63.7	12.8	1736.7	20.8	42.0	11.2
F#7-R2	75.5	15.1	1470.2	20.8	43.7	13.9
F#7-R3	54.7	11.0	1466.1	15.1	43.5	10.0
F#7-R4	39.9	7.99	1382.4	10.4	44.7	7.5
F#7-R5	41.8	8.37	796.8	6.3	47.5	8.3
F#7-R6	81.5	16.3	886.5	13.6	47.4	16.2
Tails	142.4	28.5	491.9	13.2	55.0	32.9
Calc'd Head	499.5	100.0	1066.2	100.0	47.7	100.0
Assay Head			1279.4		48.5	
F#7-R1	63.7	12.8	1736.7	20.8	42.0	11.2
F#7-R1-2	139.2	27.9	1592.2	41.6	42.9	25.1
F#7-R1-3	193.9	38.8	1556.6	56.7	43.1	35.1
F#7-R1-4	233.8	46.8	1526.9	67.0	43.4	42.6
F#7-R1-5	275.6	55.2	1416.1	73.3	44.0	50.9
F#7-R1-6	357.1	71.5	1295.3	86.8	44.8	67.1
F#7 feed	499.5	100.0	1066.2	100.0	47.7	100.0
Mass blance =	99.9%					
P ₈₀ of 38 microns						

Table 22 Results of Flotation F#8

PRODUCT	WEIGHT		TREE		SiO ₂	
	Gram	%	ppm	%dist	%	%dist
F#8-R1	32.8	6.57	1226.9	7.8	44.1	6.0
F#8-R2	32.7	6.55	1411.8	8.9	44.2	6.0
F#8-R3	29.1	5.83	1361.0	7.6	43.4	5.3
F#8-R4	41.0	8.21	1600.6	12.6	43.6	7.4
F#8-R5	41.5	8.31	1573.3	12.6	43.7	7.6
F#8-R6	59.8	12.0	1608.0	18.5	39.7	9.9
Tails	262.6	52.6	631.1	31.9	52.8	57.8
Calc'd Head	499.5	100.0	1038.7	100.0	48.0	100.0
Assay Head			1279.4		48.6	
F#8-R1	32.8	6.57	1,226.9	7.8	44.1	6.0
F#8-R1-2	65.5	13.1	1,319.2	16.7	44.1	12.1
F#8-R1-3	94.6	18.9	1,332.1	24.3	43.9	17.3
F#8-R1-4	135.6	27.1	1,413.3	36.9	43.8	24.8
F#8-R1-5	177.1	35.5	1,450.8	49.5	43.8	32.3
F#8-R1-6	236.9	47.4	1,490.5	68.1	42.8	42.2
F#8 feed	499.5	100.0	1,038.7	100.0	48.0	100.0
Mass blance =	99.9%					
P ₈₀ of 38 microns						

Appendix-5: A Summary of Preliminary Flotation

Table 23 A Summary of Preliminary Flotation

Test ID	P ₈₀	Collector	Grade of Ro. Conc, ppm	Mass pull of Ro. Conc. %	Distr. of Ro. Conc. %
	Microns		TREE	Mass	TREE
F#1	75	Armac	1082.2	18.8	14.4
F#2	75	Flotigam EDA	1159.3	57.8	53.2
F#3	63	Flotigam 4343	1211.3	21.4	21.5
F#4	63	A3030	1037.2	51.9	49.1
F#5	38	Flotigam EDA	726.3	59.7	40.6
Back calc'd. F#5			1579.5	40.3	59.4
F#6	38	OA	1576.2	45.1	70.6
F#7	38	A845	1295.3	71.5	86.8
F#8	38	A6493	1490.5	47.4	68.1

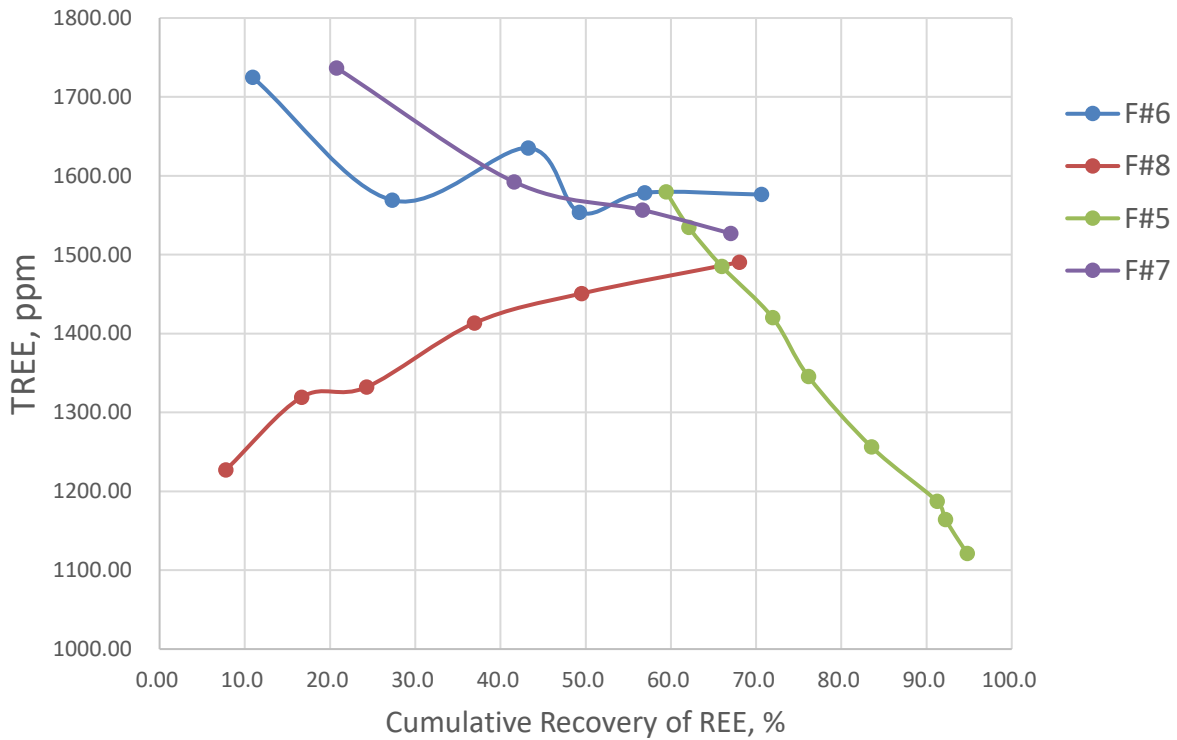

Figure 4 A Summary of Preliminary Flotation F#5-F#8