



# PRECIOUS METALS SUMMIT BEAVER CREEK

Stand-alone gold mining and  
processing at the 100% owned  
Minyari Dome Gold Project

September 2022 | ASX:AZY



# DISCLAIMER

Refer to Antipa Minerals ASX release 31 August 2022, for full Minyari Dome Project Scoping Study details. Antipa Minerals confirms that it is not aware of any new information or data that materially affects the information included in that release. All material assumptions and technical parameters underpinning that release continue to apply and have not materially changed.

**Nature of this document:** The purpose of this document is to provide general information about Antipa Minerals Limited (the 'Company'). Unless otherwise stated herein, the information in this document is based on the Company's own information and estimates. In viewing this document you agree to be bound by the following terms and conditions.

**Not an offer:** This document is for information purposes only and does not constitute or form any part of any offer or invitation to sell or issue, or any solicitation of any offer to purchase or subscribe for, any securities in the Company in any jurisdiction, including the United States. This document and its contents must not be distributed, transmitted or viewed by any person in any jurisdiction where the distribution, transmission or viewing of this document would be unlawful under the securities or other laws of that or any other jurisdiction. In particular, this document is not for release to US newswire services or distribution in the United States. This document is not considered a recommendation by the Company or any of its affiliates, directors or officers that any recipient invest in the Company nor does it constitute investment, accounting, financial, legal or tax advice.

**Not financial product advice:** This document does not take into account the individual investment objectives, financial situation and particular needs of each of the Company's Shareholders. You may wish to seek independent financial and taxation advice before making any decision in respect of this document. Neither the Company nor any of its related bodies corporate is licensed to provide financial product advice in respect of the Company's securities or any other financial products.

**Forward looking statements:** Certain statements contained in this document, including information as to the future financial or operating performance of the Company and its projects, are forward looking statements. Such forward looking statements: (a) are necessarily based upon a number of estimates and assumptions that, while considered reasonable by the Company, are inherently subject to significant technical, business, economic, competitive, political and social uncertainties and contingencies; (b) involve known and unknown risks and uncertainties that could cause actual events or results to differ materially from estimated or anticipated events or results reflected in such forward looking statements; and (c) may include, among other things, statements regarding estimates and assumptions in respect of prices, costs, results and capital expenditure, and are or may be based on assumptions and estimates related to future technical, economic, market, political, social and other conditions.

The Company disclaims any intent or obligation to publicly update any forward looking statements, whether as a result of new information, future events or results or otherwise. The words "believe", "expect", "anticipate", "indicate", "contemplate", "target", "plan", "intends", "continue", "budget", "estimate", "may", "will", "schedule" and similar expressions identify forward looking statements. All forward looking statements contained in this document are qualified by the foregoing cautionary statements. Recipients are cautioned that forward looking statements are not guarantees of future performance and accordingly recipients are cautioned not to put undue reliance on forward looking statements due to the inherent uncertainty therein.

**Disclaimer:** No representation or warranty, express or implied, is made by the Company that the material contained in this document will be achieved or prove to be correct. Except for statutory liability which cannot be excluded, each of the Company, its directors, officers, employees, advisers and agents expressly disclaims any responsibility for the accuracy, fairness, sufficiency or completeness of the material contained in this document, or any opinions or beliefs contained in this document, and excludes all liability whatsoever (including in negligence) for any loss or damage which may be suffered by any person as a consequence of any information in this document or any error or omission there from. The Company is under no obligation to update or keep current the information contained in this document or to correct any inaccuracy or omission which may become apparent, or to furnish any person with any further information, unless required to do so by law. Any opinions expressed in the document are subject to change without notice. Recipients of this document should make their own, independent investigation and assessment of the Company, its business, assets and liabilities, prospects and profits and losses, as well as the matters covered in this document. Independent expert advice should be sought before any decision based on an assessment of the Company is made.

**Unverified information:** This document may contain information (including information derived from publicly available sources) that has not been independently verified by the Company.

**Cautionary note regarding reserves and resources:** You should be aware that as an Australian company with securities listed on the ASX, the Company is required to report reserves and resources in accordance with the Australasian Code for Reporting of Exploration Results, Mineral Resources and Ore Reserves (JORC Code, 2012 Edition). You should note that while the Company's reserve and resource estimates comply with the JORC Code, they may not comply with the relevant guidelines in other countries and, in particular, do not comply with Industry Guide 7, which governs disclosures of mineral reserves in registration statements filed with the US Securities and Exchange Commission. Information contained in this document describing the Company's mineral deposits may not be comparable to similar information made public by companies subject to the reporting and disclosure requirements of US securities laws. In particular, Industry Guide 7 does not recognise classifications other than proven and probable reserves and, as a result, the SEC generally does not permit mining companies to disclose their mineral resources in SEC filings. You should not assume that quantities reported as "resources" will be converted to reserves under the JORC Code or any other reporting regime or that the Company will be able to legally and economically extract them.

**Competent Persons Statement - Exploration Results:** Please refer to the detailed statement at the end of this document.

**Competent Persons Statement - Mineral Resource Estimations:** for the Minyari Dome Project Deposits, Calibre Deposit, Magnum Deposit, Chicken Ranch Deposit and Tims Dome deposit: Please refer to detailed statement at end of this document.

**Australian Dollars:** All figures in Australian Dollars unless stated otherwise.

**Release Authorised by:** Roger Mason - Managing Director.

# THE ANTIPA MINERALS PORTFOLIO

Rapid advancement of our flagship Minyari Dome Project

# 2.7 Moz GOLD ONLY

## ATTRIBUTABLE MINERAL RESOURCE

# 5,100 km<sup>2</sup>

## OF HIGHLY PROSPECTIVE GOLD AND COPPER GROUND

## OUTSTANDING LOCATION PROXIMAL TO THE GOLD-COPPER-SILVER TELFER MINE AND HAVIERON AND WINU DEVELOPMENT PROJECTS

### SCOPING STUDY CONFIRMS STAND-ALONE PROJECT POTENTIAL

# A

## Minyari Dome 100% Antipa

### COMPLEMENTARY MAJOR GROWTH PROJECTS

- B** Citadel (35%) : Rio Tinto JV<sup>1</sup>
- C** Wilki (100%) : Newcrest Farm-in
- D** Paterson (100%): IGO Farm-in

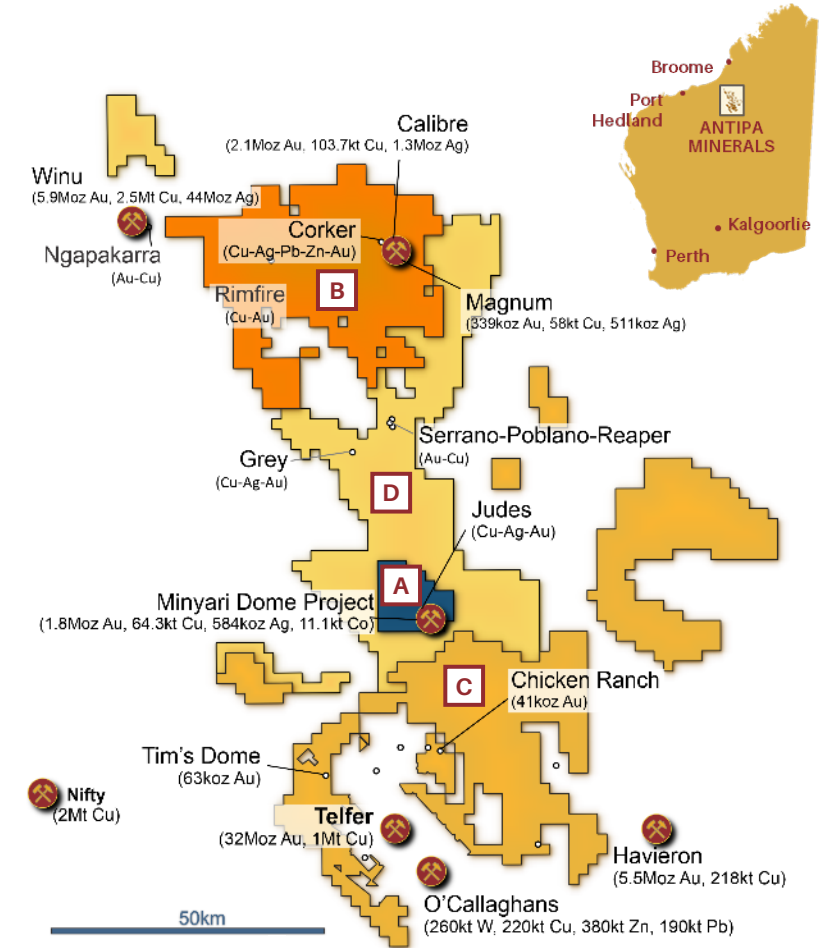

1. Antipa currently holds a 35% Joint Venture interest, however, has elected to utilise the dilute-down provisions in the Citadel JV agreement for the CY 2022 exploration programme, which will result in a recalculation of this interest at the end of CY2022.

# CORPORATE SNAPSHOT

High quality register, strong strategic cornerstone investment

## CAPITAL STRUCTURE | ASX : AZY

Share price <sup>1</sup>	A\$ 0.031
Shares on issue <sup>1</sup>	3,139.7 M
Market capitalisation <sup>1</sup>	A\$ 97.3 M
Cash <sup>2</sup>	A\$ 6.5 M
Debt <sup>2</sup>	Nil
EV	A\$ 90.8 M
Options <sup>1</sup>	236.7 M

## SHARE REGISTER

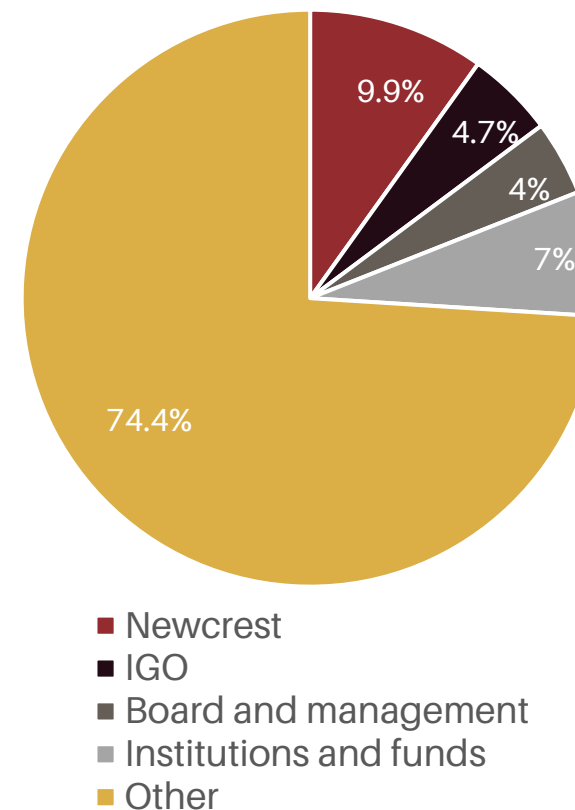

1. At 7 September 2022.  
2. At 30 June 2022, Antipa cash only (excludes Farm-in funds).



# BOARD AND MANAGEMENT

Proven value creators



**Stephen Power**  
Non-executive Chairman

- Corporate lawyer with more than 30 years of legal, commercial and corporate management experience
- Former advisor to LionOre Mining International



**Roger Mason**  
Managing Director

- Geologist with 35 years experience spanning exploration, production and acquisition projects
- Former General Manager Geology for LionOre Australia and Norilsk Nickel Australia
- Former consultant to Integra Mining Ltd



**Mark Rodda**  
Executive Director –  
Commercial and Legal

- Lawyer and corporate consultant
- 25 years legal, commercial and corporate management experience
- Director of Lepidico
- Former Chairman of Coalspur Mines, and former General Counsel of LionOre Mining international



**Peter Buck**  
Non-Executive Director

- Geologist
- 40 years industry experience across international exploration, acquisition and production
- Current Director of IGO
- Previously Director of PMI Gold, Gallery Gold, LionOre Australia and Breakaway Resources



**Gary Johnson**  
Non-Executive Director

- Metallurgist
- 40 years of industry experience covering plant design, project development and operations
- Chairman of Lepidico, and Director of Strategic Metallurgy
- Former Director of LionOre's Tati Nickel



**Luke Watson**  
CFO and Company  
Secretary

- Chartered Accountant with 20 years experience
- Held senior corporate and finance positions with several listed exploration and development companies
- Former CFO and Company Secretary of Mantra Resources

# A

# MINYARI DOME PROJECT

## 100% ANTIPA

Scoping Study confirms sizeable stand-alone project potential with clear and substantial upside

**AU** **1.8** Moz 2022 RESOURCE AT 1.6 g/t PLUS



**Cu** 64 kt at 0.19%

**Co** 11 kt at 0.03%

**Ag** 584 koz at 0.54 g/t

INDICATED RESOURCE **1.0** Moz GOLD AT **1.4** g/t GOLD



-  **Technically and commercially robust**  
Stand-alone gold mining and processing operation
-  **Strategically significant location**  
35km from the Telfer mine and processing facility
-  **Outstanding existing infrastructure**  
Easy access to Port Hedland regional hub
-  **Highly leveraged to resource upside**  
Aggressive growth drilling programme underway
-  **Progression to PFS approved**  
To incorporate expected updated resource estimate

# SCOPING STUDY HIGHLIGHTS

Stand-alone gold mining and processing facility at Minyari Dome

## MINE SCHEDULE

**21.4 Mt at 1.6 g/t gold**

Initial open pit and underground mine

## MINING PHYSICALS

**3 Mtpa throughput**

For 7+ years initial processing life

## STANDARD CIL PLANT

**90% gold recovery**

Simple non-refractory metallurgy

## INITIAL GOLD OUTPUT

**975 koz**

Average of 168 koz pa for the first five years

## FORECAST AISC

**A\$1,475/oz gold**

For US\$1,062/oz gold

## CAPITAL COST

**A\$275M**

Including pre-production mining A\$68M

**NPV<sub>7%</sub>**

**A\$392M**

Pre-tax at A\$2,430/oz gold

**IRR**

**34%**

Pre-tax at A\$2,430/oz gold

**PAYBACK**

**2.5 years**

Pre-tax from first production

# SCOPING STUDY HIGHLIGHTS

## Detailed study outcomes

### KEY MINYARI DOME PARAMETERS ( $\pm 35\%$ )

Ore tonnage	Mt	21.4
Grade gold	g/t	1.6
Contained ounces gold	koz	1,090
Plant throughput	Mtpa	3.0
Processing life (excluding pre-production)	Years	7+
Strip ratio open pit	waste:ore	5:1
LOM <sup>1</sup> Gold production	koz	975
Annual Gold production - first five years	koz	168
Total development capital (including pre-production mining)	A\$M	275
Average LOM operating cost	A\$/t ore milled	70
Gold price	US\$/oz	1,750
Silver price	US\$/oz	22
Exchange rate	AUD:USD	0.72
Royalty rate (WA Government and Sandstorm)	NSR %	3.5
AISC - LOM average	US\$/oz gold	1,062
Net cash flow (undiscounted, pre-tax)	A\$M	672
NPV <sub>7%</sub> (pre-tax)	A\$M	392
IRR (pre-tax)	%	34
Payback period (pre-tax)	Years	2.5



## UNLOCKING FULL VALUE AT MINYARI

- This study represents just the beginning – a base case assessment for a stand-alone development at Minyari Dome
- Aggressive drilling and resource work is expected to deliver future Mineral Resource growth
- All potential third-party development pathways remain open for assessment

1. LOM is "Life of Mine".



# POTENTIAL UPSIDE DRIVERS

Three key project value levers

1



## MINERAL RESOURCE EXPANSION

**Minyari ± WACA extensional  
plunge resource targets**

Plus new and satellite extensional resource targets to be evaluated as part of an aggressive exploration programme

2



## MINE SCHEDULING REVISION

**Future exploration success to  
optimise processing**

With immediate potential to push-back the final two years of lower grade stockpile processing

3

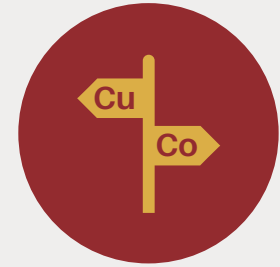

## ADDITIONAL PROJECT OPTIMISATION

**Potential copper and cobalt  
by-product outputs**

Test-work aimed at unlocking significant value of these future facing metals

# POTENTIAL UPSIDE DRIVERS

## 1. Mineral Resource Extension Opportunities

### DRILL TESTING

PHASE 1 - 13,000M OF RC AND DIAMOND CORE DRILLING RECENTLY COMPLETED (AWAITING ASSAY RESULTS) AND PHASE 2 DRILLING PROGRAMME COMMENCING SOON

- **Minyari Keel Zone**  
Minyari fold nose region untested along a significant plunge extent
- **Minyari Down Plunge**  
High-grade mineralisation open down plunge
- **Minyari South**  
High-grade mineralisation open in several directions
- **Sundown**  
Open in several directions - intense Minyari-style alteration increasing at depth
- **WACA Down Plunge**  
High-grade mineralisation open down plunge
- **WACA West**  
Narrow high-grade mineralisation within thick (100m downhole) low-grade zone open in all directions located 100m west of WACA

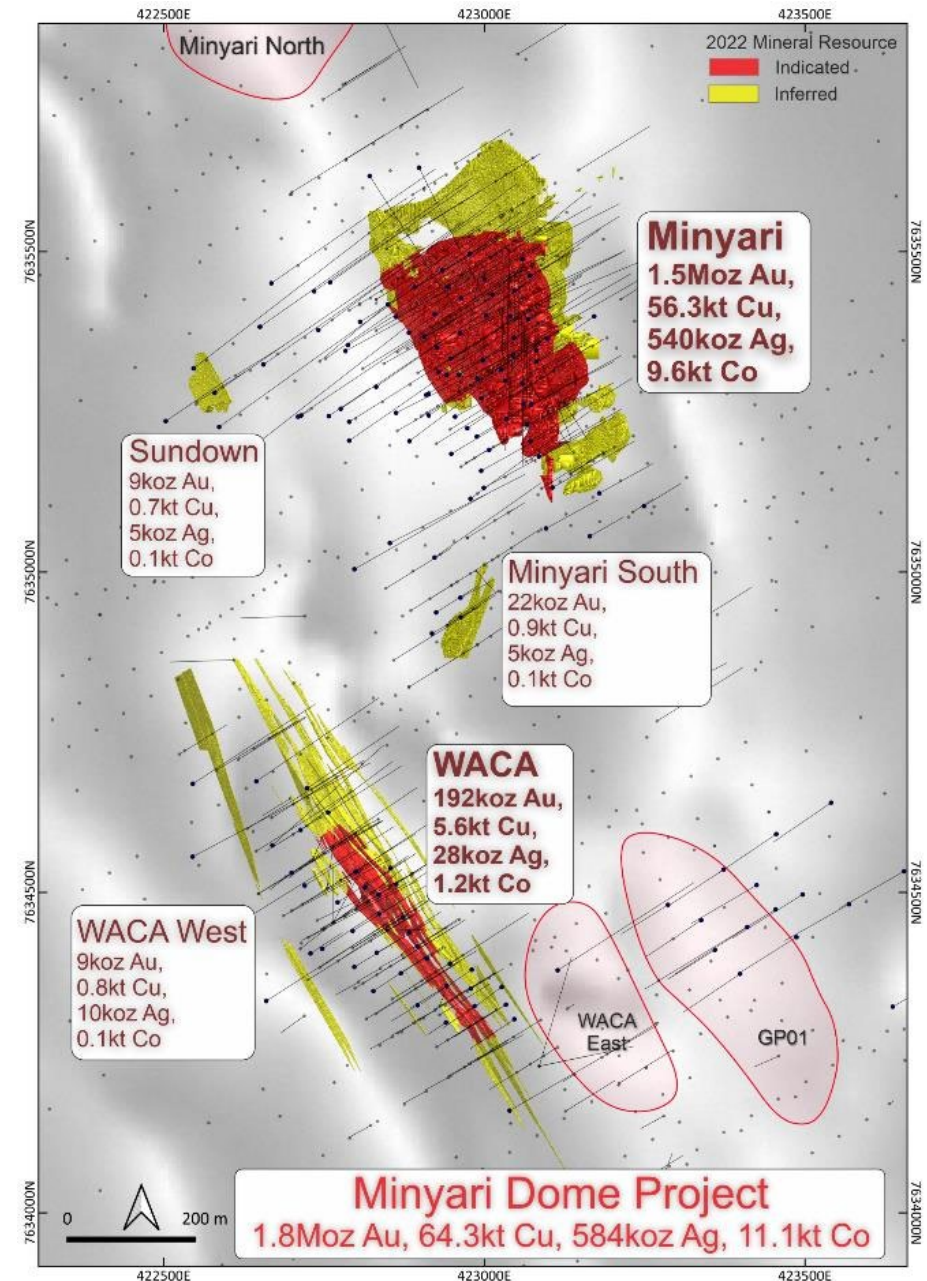

# POTENTIAL UPSIDE DRIVERS

## 1. Mineral Resource Extension Opportunities – Minyari Plunge Target

- Thick pipe like breccia mineralisation starting at surface and remaining open below 670 metres depth – delivers 3,300oz per vertical metre
- The intensity of this style of intrusion related breccia mineralisation can rapidly increase
- Analogous to the nearby Havieron deposit – without the 430m of challenging barren cover
- Havieron 5.5Moz gold resource extends to 1,400m below surface – delivers 5,500oz per vertical metre
- Wide open down plunge targets – potential for substantially higher-grade zones of mineralisation

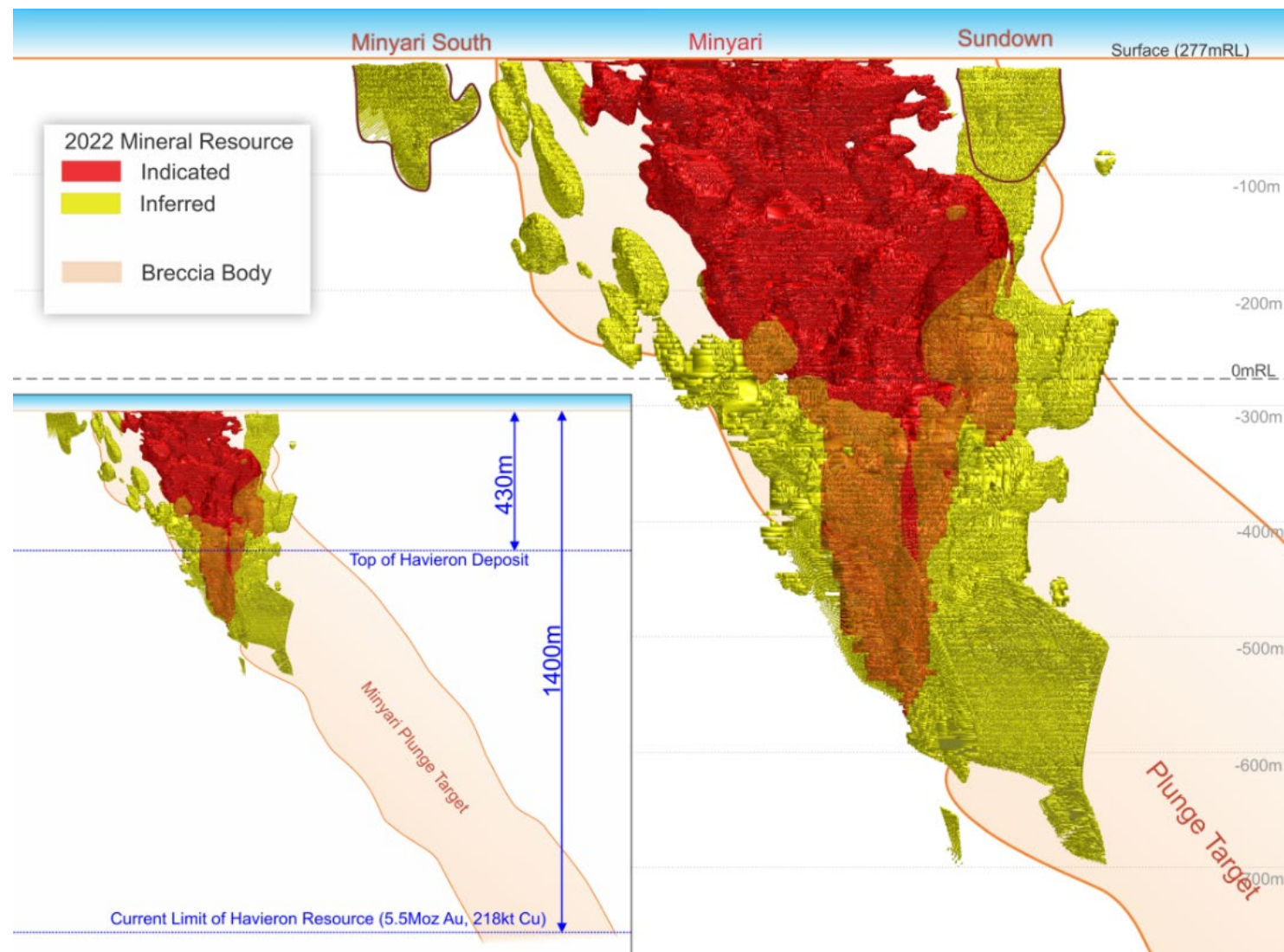



# POTENTIAL UPSIDE DRIVERS

## 1. Maiden Mineral Resource Opportunities

- Minyari North**  
 Coincident magnetic-high and IP chargeability anomaly approx. 400m north of Minyari with 2021 drilling intersecting encouraging alteration including sulphides results included 28m at 0.5 g/t gold and 0.20% copper
- GP01**  
 2021 discovery drill results included 27m at 1.3 g/t gold and 0.11% copper 350m east of WACA with mineralisation and broad intense Minyari-style hydrothermal alteration remaining open along strike and down dip
- WACA East**  
 2021 discovery drill results included 9m at 1.0 g/t gold and 0.12% copper 150m east of WACA with mineralisation remaining open along strike and down dip
- Judes**  
 Copper-silver±gold prospect 1.8km northwest of Minyari with drill intersections including 10m at 2.05% copper, 9.11 g/t silver and 0.19 g/t gold
- Other Targets**  
 Geophysical, soil geochemical anomalies and conceptual targets, including the recently identified four high-priority gold copper and pathfinder soil anomalies

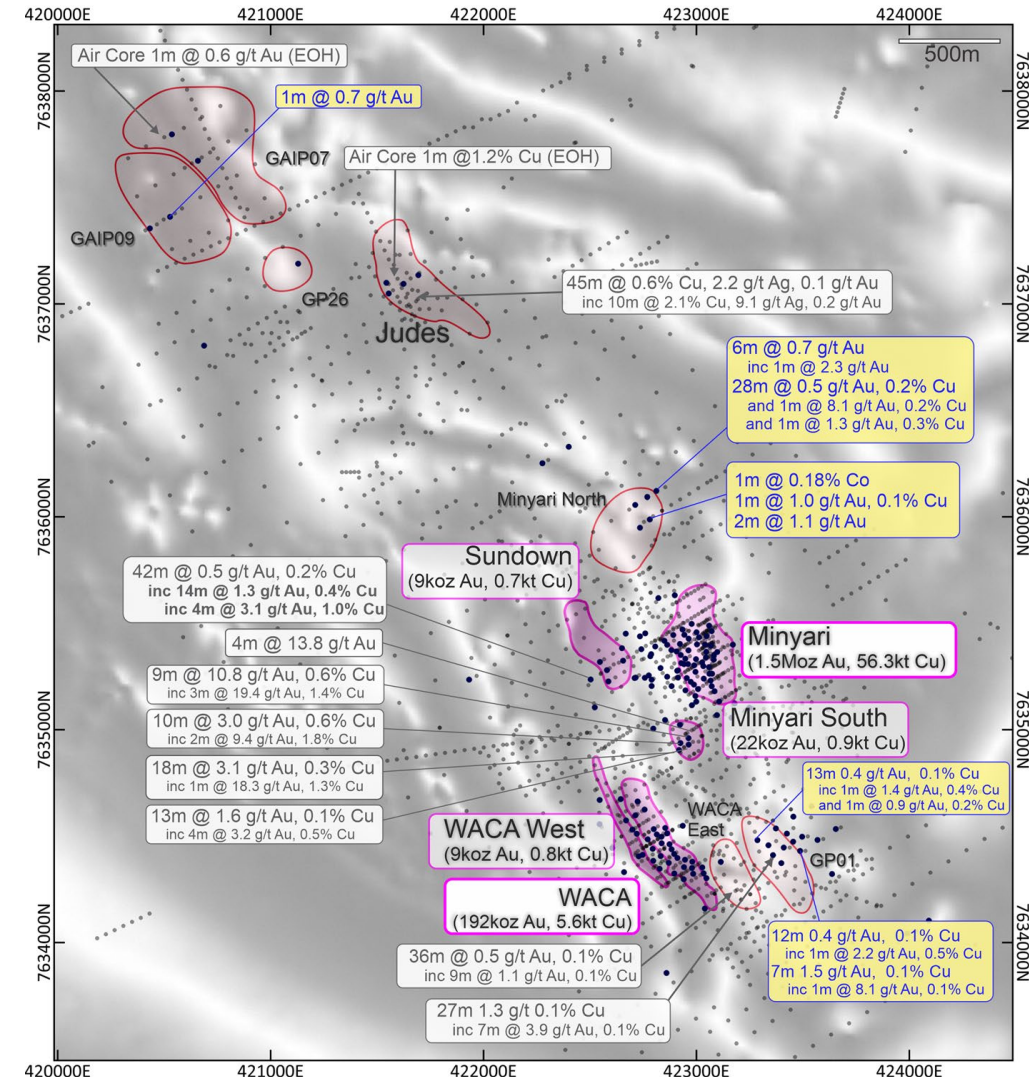

# POTENTIAL UPSIDE DRIVERS

## 2. Mine Scheduling Revision

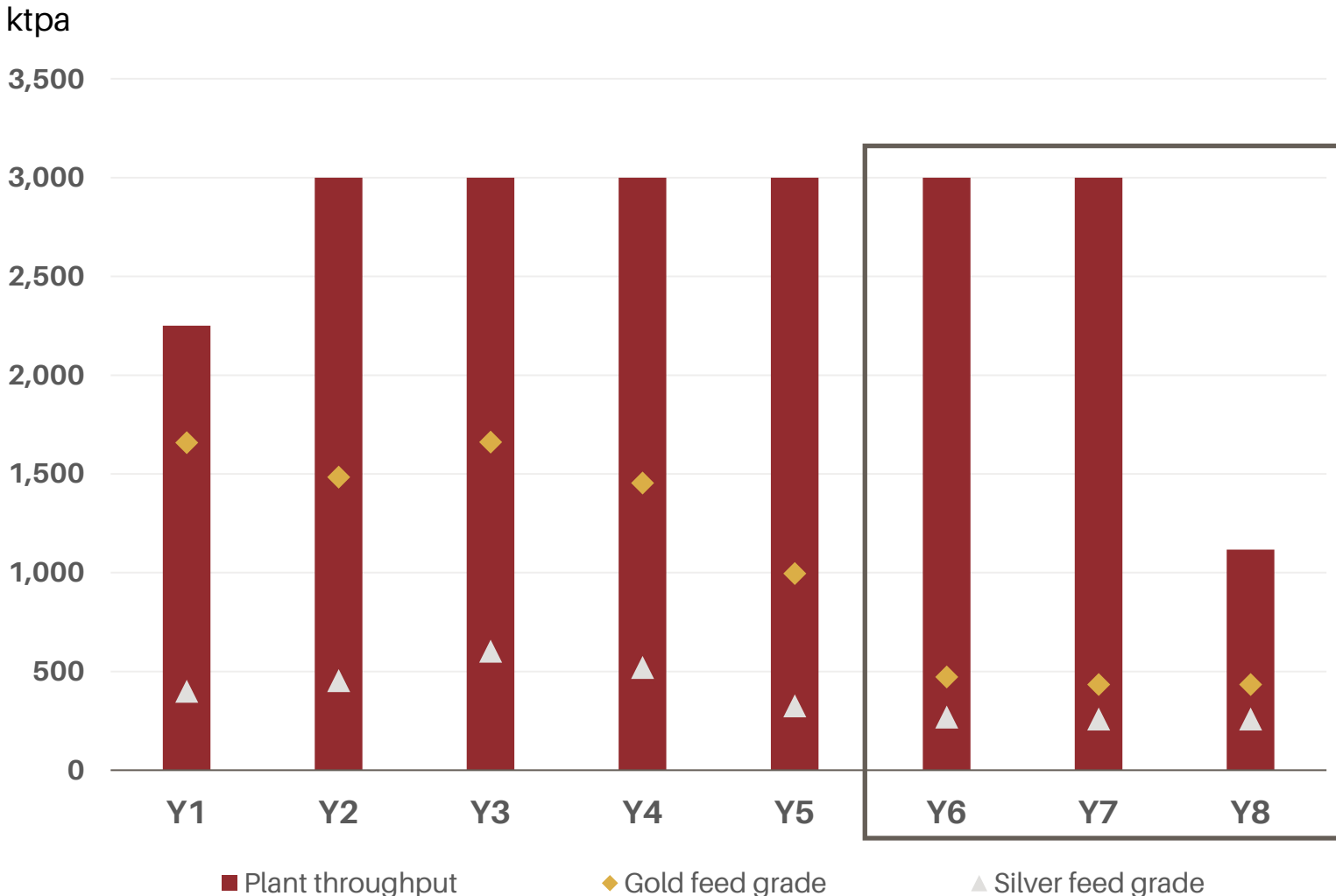

**IMMEDIATE  
POTENTIAL TO  
PUSH-BACK THE  
PROCESSING OF  
LOWER GRADE  
STOCKPILES**

# POTENTIAL UPSIDE DRIVERS

## 3. Additional Project Optimisation



### POTENTIAL TO UNDERTAKE MORE DETAILED EVALUATION OF POLYMETALLIC DEVELOPMENT OPPORTUNITIES

- Minyari Dome May 2022 Mineral Resource Estimate also contains 64,300 tonnes of copper and 11,100 tonnes of cobalt
- Preliminary metallurgical test-work delivers copper and cobalt concentrates using standard industry flotation and gravity processes
- Copper and cobalt by-product outputs may provide additional future value streams



**PRE-FEASIBILITY STUDY  
METALLURGICAL TEST-WORK  
OBJECTIVE TO IMPROVE  
PROCESSING RECOVERIES FOR  
COPPER AND COBALT AND  
INCREASE CONCENTRATE  
GRADES -  
WITH COBALT A FOCUS**



# DEVELOPMENT TIMELINE

Prioritising the rapid advancement of our flagship Minyari Dome Project

## MINYARI DOME

RAPID  
ADVANCEMENT  
FOCUS



STUDIES  
+  
MINERAL  
RESOURCE  
EXPANSION

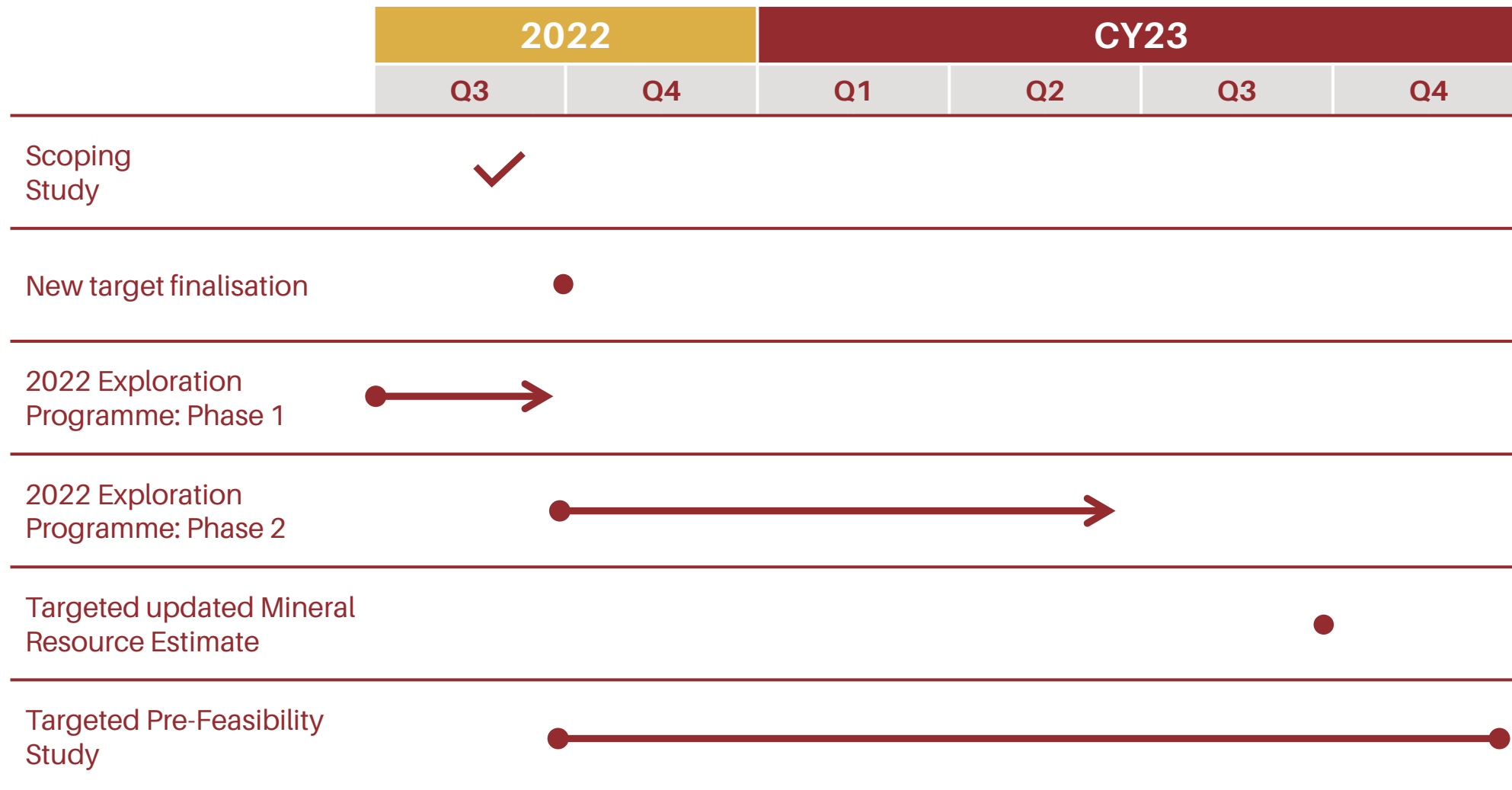

Exploration programmes and development studies are subject to any changes which may be made consequent upon results, field conditions and ongoing review.



# COMPLEMENTARY MAJOR GROWTH PROJECTS

**B** CITADEL JV (35% Antipa and 65% Rio Tinto)

**C** WILKI FARM-IN (100% Antipa - Newcrest Mining Ltd farming in)

**D** PATERSON FARM-IN (100% Antipa - IGO Ltd farming in)

# **B** CITADEL JV PROJECT (35%)

Significant gold-copper-silver resource

**STRATEGIC**

JOINT VENTURE  
WITH

**RIO  
TINTO<sup>2</sup>**



**1,200km<sup>2</sup>**  
OF PROJECT AREA

**8,500M**  
DRILL PROGRAMME  
FOR 2022<sup>1</sup>

**108 MT MINERAL RESOURCE**

<b>Au</b>	<b>2.4 Moz</b> (0.85 Moz attrib.) at 0.72 g/t
<b>Cu</b>	<b>162 kt</b> (56.7 kt attrib.) at 0.15%
<b>Ag</b>	<b>1.8 Moz</b> (0.63 Moz attrib.) at 0.54 g/t

WITHIN  
**45 km**  
OF  
**RIO'S WINU**  
COPPER-GOLD-SILVER  
PROJECT

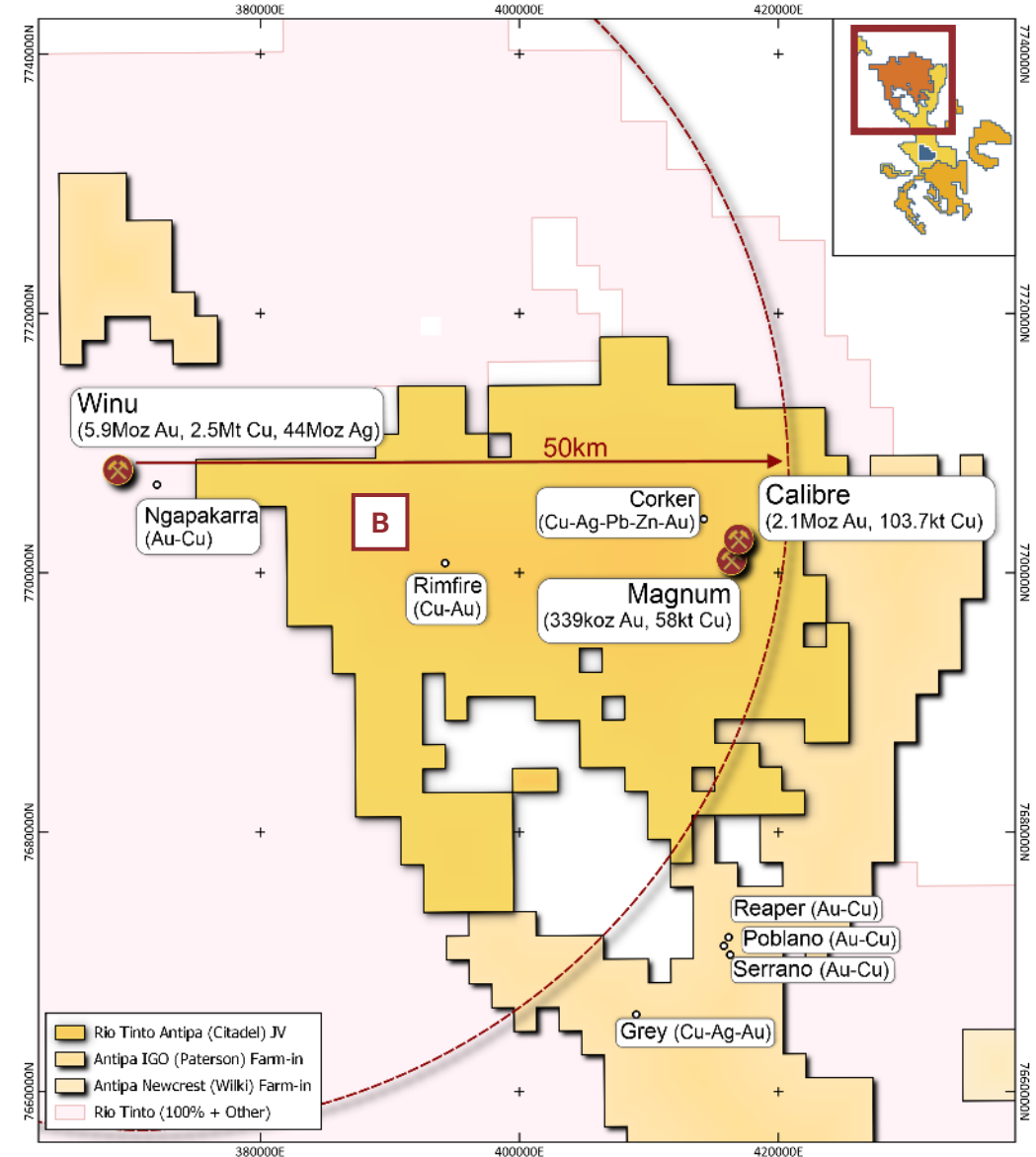

1. Antipa currently holds a 35% Joint Venture interest, however, has elected to utilise the dilute-down provisions in the Citadel JV agreement for the CY 2022 exploration programme, which will result in a recalculation of this interest at the end of CY2022.



# C WILKI FARM-IN PROJECT

A compelling greenfield opportunity

**MASSIVE**  
**2,200km<sup>2</sup>**  
**LAND**  
**HOLDING**

**ATTRACTIVE FARM-IN**  
**AGREEMENT WITH**  
**NEWCREST**  
**MINING<sup>1</sup>**

**A\$60M**  
**SPEND FOR**  
**75% JV**  
**INTEREST**

**+A\$6M**

**SPENT BY**  
**NEWCREST TO**  
**DATE**



**2.4 MT MINERAL RESOURCE**

**Au** **103.5 koz at 1.3 g/t**

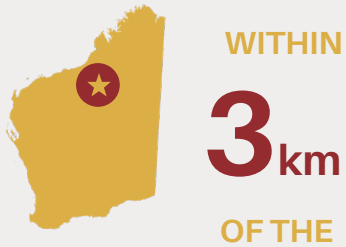

WITHIN

**3km**

OF THE

**TELFER**

**GOLD-COPPER-SILVER**  
**MINE AND 22Mtpa**  
**PROCESSING FACILITY**

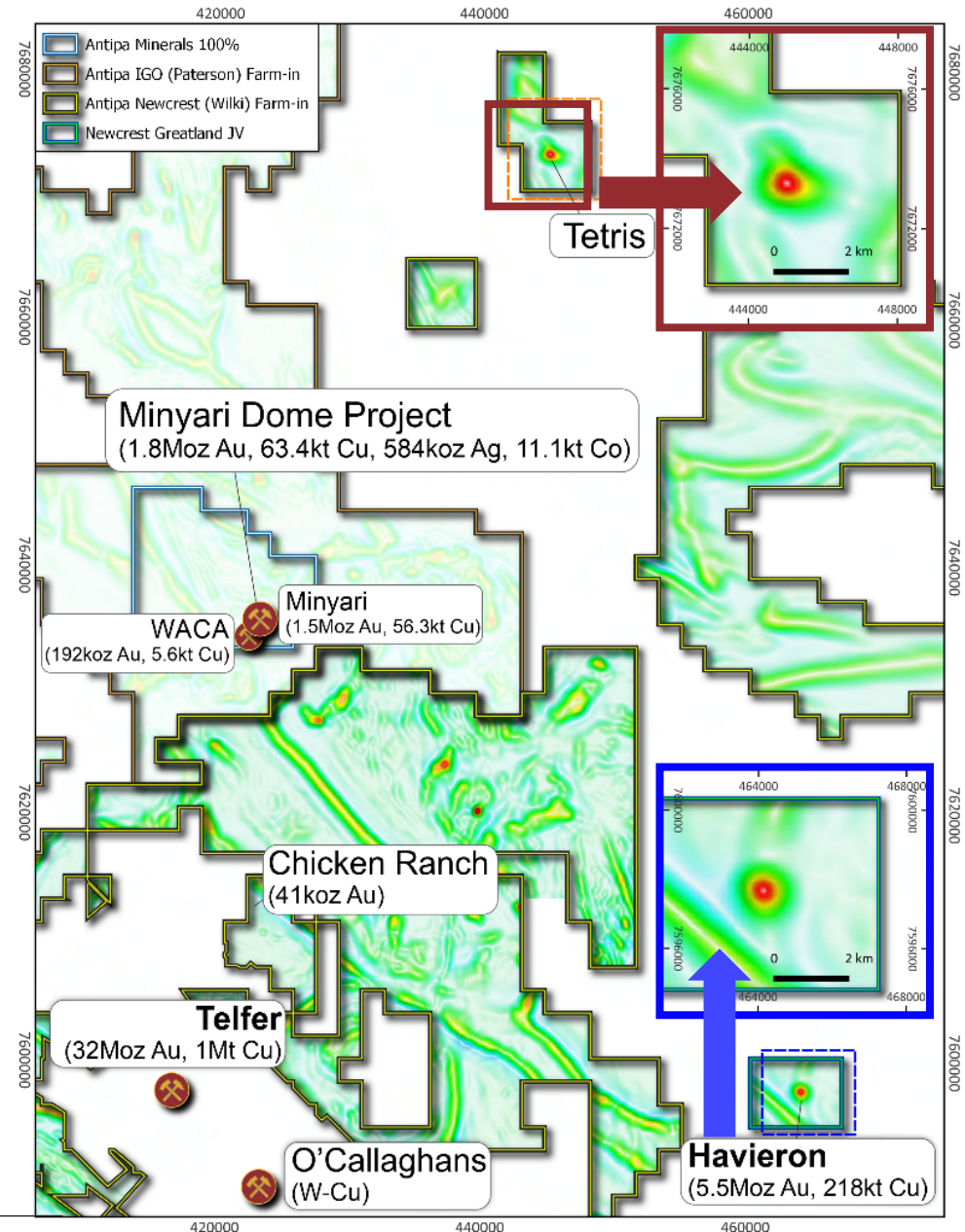

1. Newcrest may earn a 51% interest in the Wilki Project by funding A\$16M of exploration by March 2025 (consisting of A\$6M of exploration before March 2022 to be managed by Antipa, initial condition satisfied December 2021, and a further A\$10M of exploration before March 2025 to be managed at Newcrest's option - currently managed by Newcrest) and up to 75% by sole funding a further A\$44M before March 2028 (to be managed at Newcrest's option).

# D PATERSON FARM-IN PROJECT

Limited historic drilling, massive potential

LARGE  
**1,550km<sup>2</sup>**  
LAND  
HOLDING

WITHIN  
**22km**

OF THE  
**TELFER**

GOLD-COPPER-SILVER  
MINE AND 22Mtpa  
PROCESSING FACILITY

ATTRACTIVE FARM-IN  
AGREEMENT WITH

**IGO**<sup>1</sup>



GOLD-COPPER-SILVER  
INTERSECTED

**NIFTY, WINU, TELFER  
AND HAVIERON  
ANALOGUE TARGETS**

**A\$30M**  
SPEND FOR 70%  
JV INTEREST  
**ANTIPA**

FREE CARRIED TO  
COMPLETION OF  
FEASIBILITY STUDY

**+A\$4M**

SPENT BY IGO TO DATE

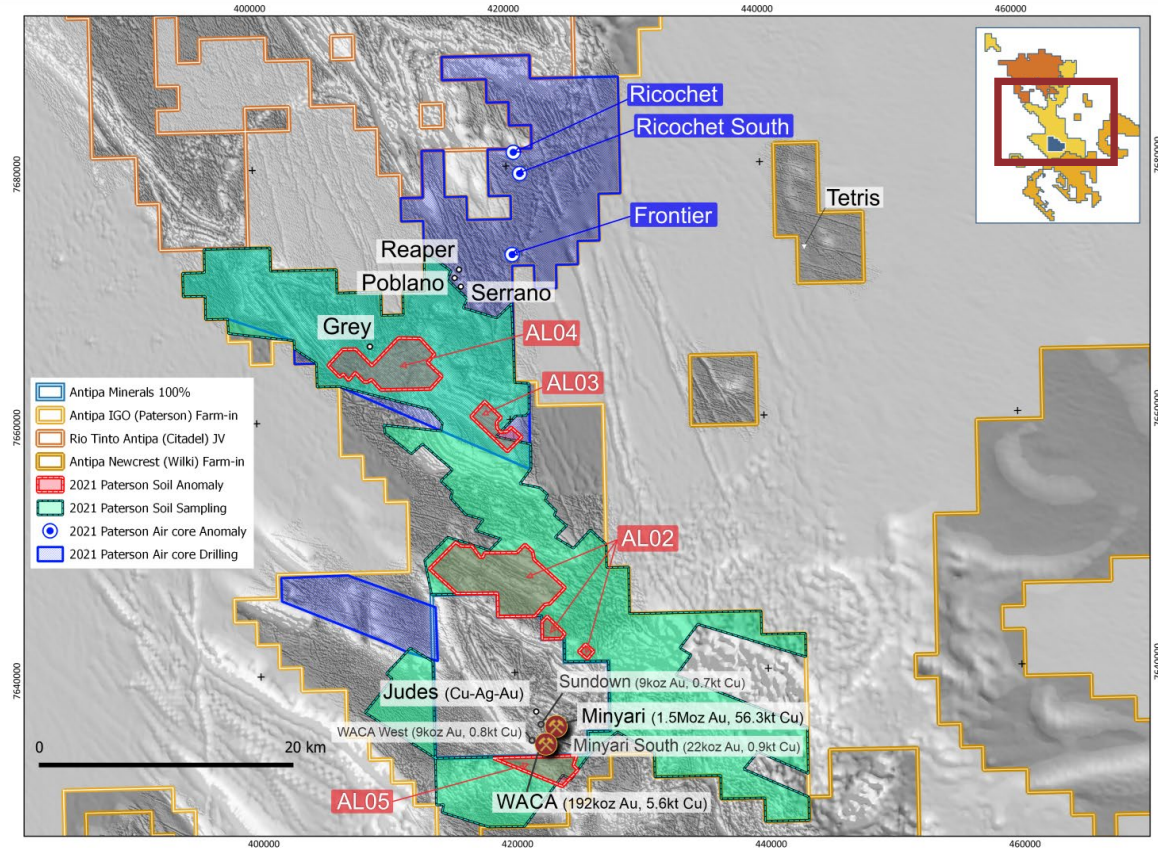

1. IGO may earn a 70% interest in the Paterson Project by funding a total of \$30M consisting of A\$4M of exploration by January 2023 (Stage 1 condition satisfied December 2021) and a further A\$26M by January 2027 (Stage 2 to be managed at IGO's option - currently managed by IGO). Upon joint venture formation, IGO shall free-carry Antipa to completion of a Feasibility Study.

# PLANNED DISCOVERY ACTIVITY SCHEDULE

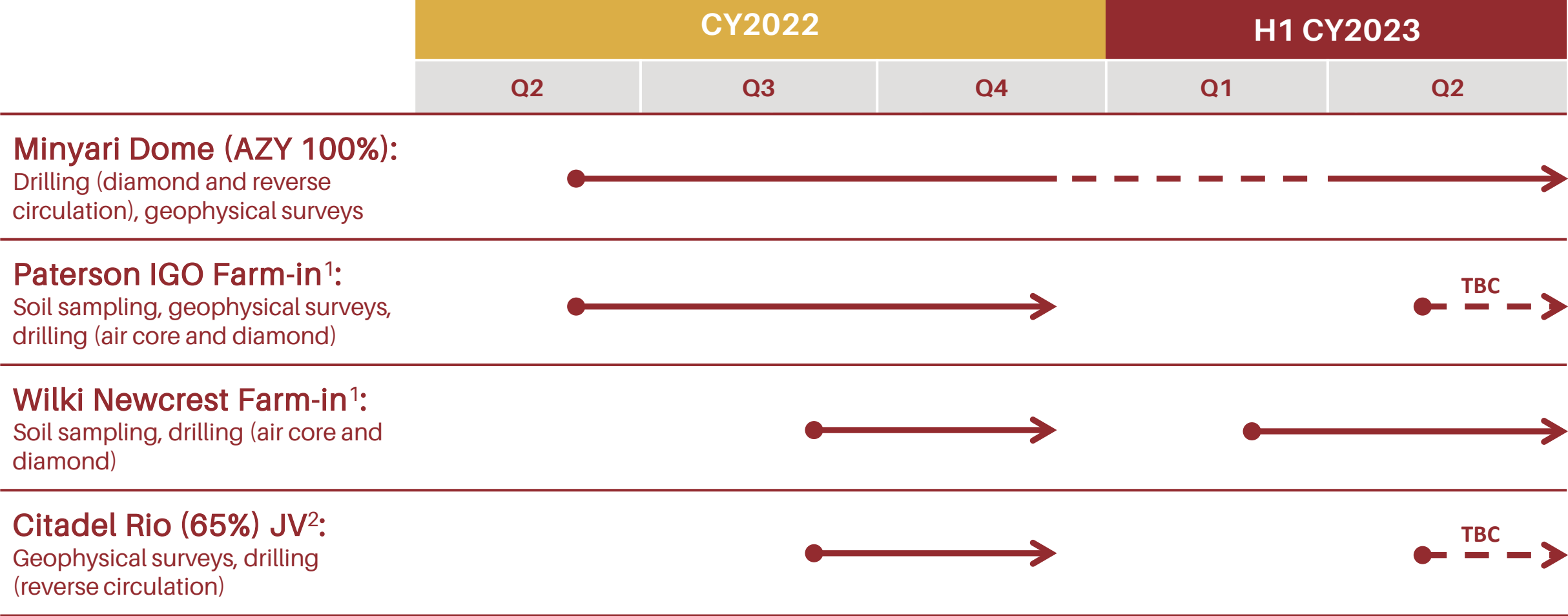

Exploration programmes are subject to any changes which may be made consequent upon results, field conditions and ongoing review.

1. Fully funded by respective farm-in partners, IGO and Newcrest.  
 2. CY2022 exploration programme fully funded by joint venture partner Rio Tinto.



# EMERGING TIER 1 GOLD AND COPPER BUSINESS



**2.7** Moz  
GOLD  
ONLY

ATTRIBUTABLE  
MINERAL  
RESOURCE

**5,100** km<sup>2</sup>

OF HIGHLY  
PROSPECTIVE GOLD  
AND COPPER GROUND

## OUTSTANDING LOCATION

PROXIMAL TO THE TELFER  
MINE AND HAVIERON AND  
WINU PROJECTS

- Paterson region has been historically underexplored
- Prospective frontier for the discovery of multi-cycle, tier-one gold-copper deposits
- In the last 6 years > 16Moz of gold and > 3Mt of copper discovered
- Western Australia is a low-risk, mining-friendly jurisdiction

## RESOURCE DEFINED

WITH FUTURE  
EXPANSION  
POTENTIAL

- Now hosting a 2.7 Moz gold only attributable JORC resource
- Scoping Study outcomes demonstrate technical and commercial viability for a stand-alone development at the 100% owned Minyari Dome Project
- Additional, significant exploration across the portfolio throughout CY22
- Current and future value pathways for shareholders

## HIGH-QUALITY STRATEGIC PARTNERS

AND CONTINUING  
EXPLORATION  
PROGRAMMES

- Strategic JV and farm-in agreements with Rio Tinto, Newcrest and IGO
- Combined historical partner contribution of +A\$50M of exploration spend
- Cumulative potential free-carry exploration spend of up to A\$115M
- Strong major discovery objectives and actions

# CONTACT

## Managing Director

Mr Roger Mason

E: [roger.mason@antipaminerals.com.au](mailto:roger.mason@antipaminerals.com.au)

## Executive Director

Mr Mark Rodda

E: [mark.rodde@antipaminerals.com.au](mailto:mark.rodde@antipaminerals.com.au)

## Media Relations

Mr Michael Vaughan

Fivemark Partners

E: [michael.vaughan@fivemark.com.au](mailto:michael.vaughan@fivemark.com.au)

T: +61 422 602 720

## Corporate Office

Level 2, 16 Ord Street  
West Perth WA 6005  
Australia

PO Box 795  
West Perth WA 6872

T: +61 8 9481 1103  
E: [admin@antipaminerals.com.au](mailto:admin@antipaminerals.com.au)

**ANTIPAMINERALS.COM.AU**







ANTIPAMINERALS



# APPENDIX

Scoping Study, Mineral Resource detail and other additional information

# PRODUCTION PROJECTION

At throughput rate 3 Mtpa ore

**AVERAGE 168 koz pa**

**GOLD**

Over the first five years of mining

**AVERAGE 44 koz pa**

**SILVER**

Over the life of mine

**MINYARI DEPOSIT**

**96%**

Of production over the evaluation period

Minyari Dome Project gold and silver recovered output schedule

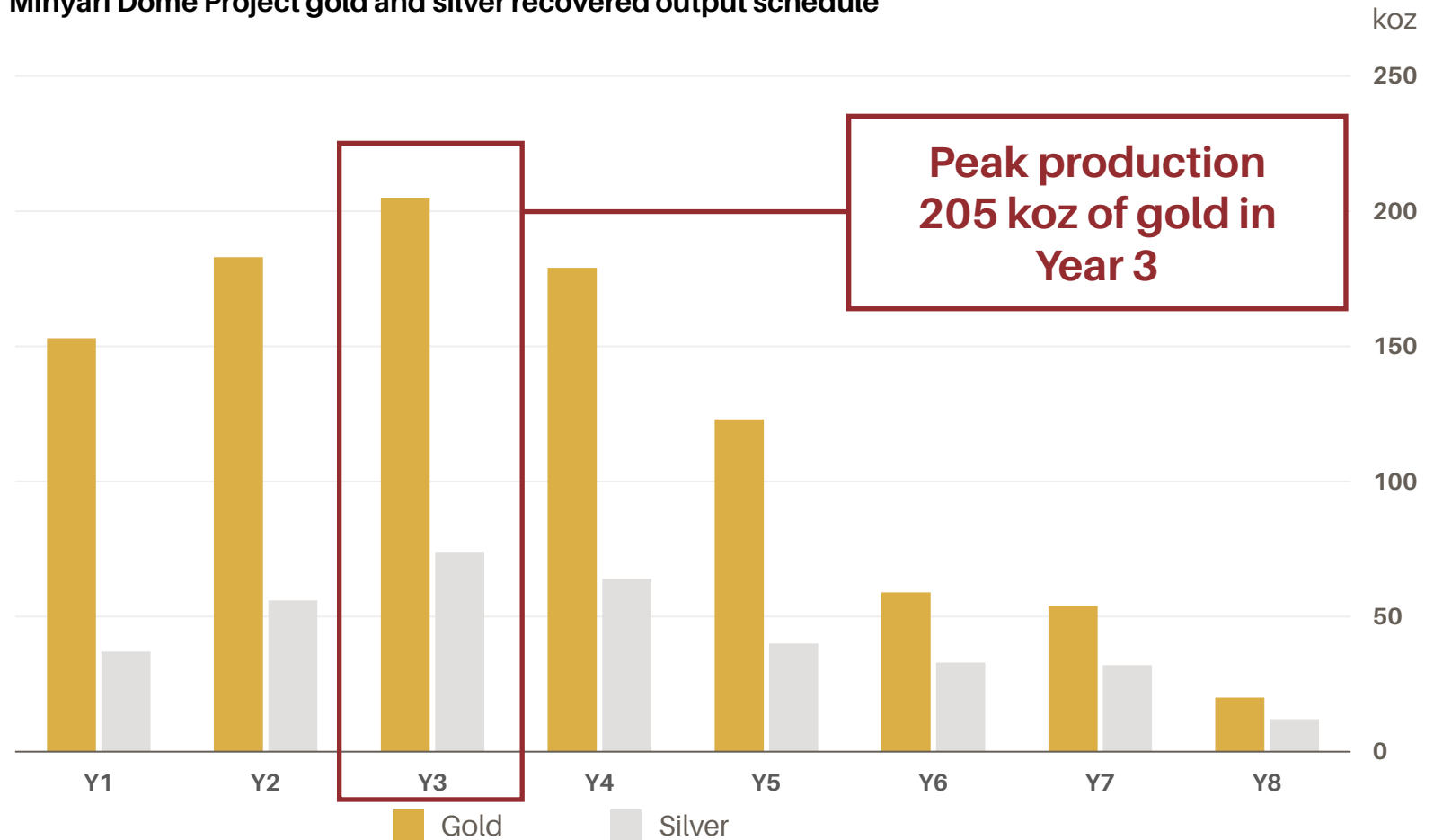

**Peak production  
205 koz of gold in  
Year 3**

# PROJECT NPV SENSITIVITY ANALYSIS

Tremendous upside to bull market gold pricing

**IRR**  
**34%**  
(pre-tax)

**UNLEVERED PAYBACK**  
**2.5**  
years (pre-tax)

**NET CASH FLOW**  
**A\$672M**  
undiscounted (pre-tax)

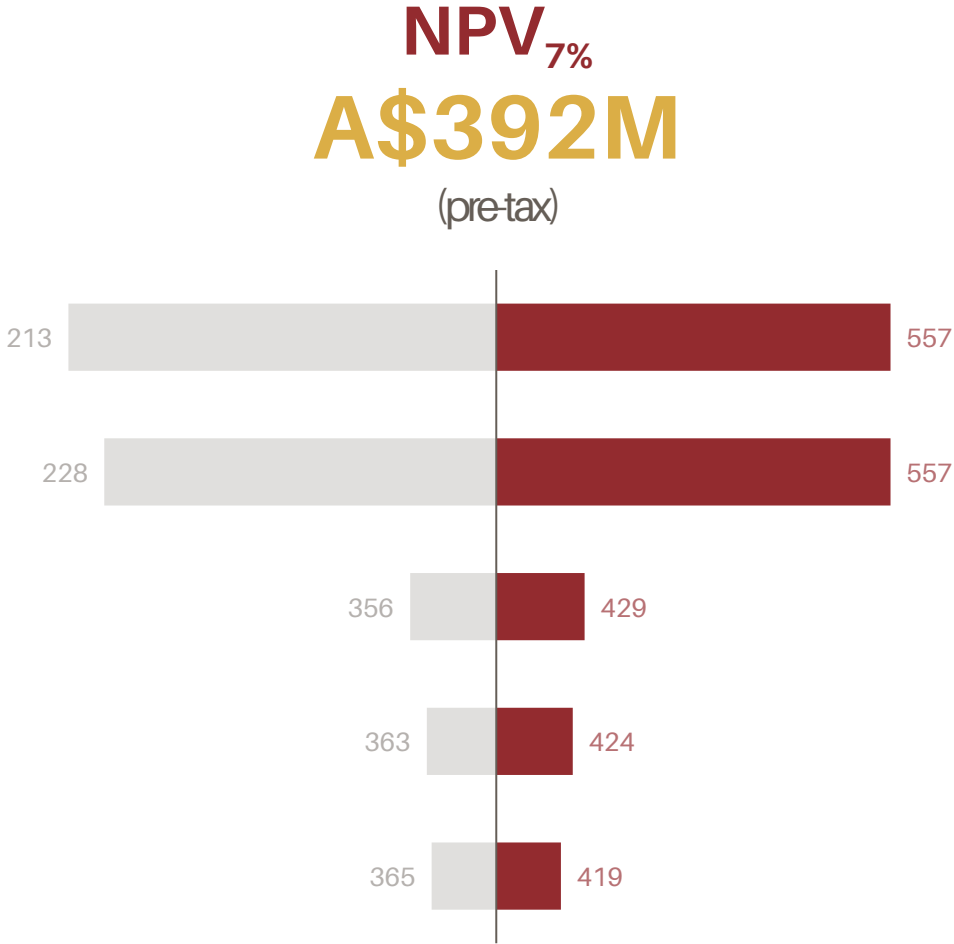



# MINING METHODS

Contractor mining at three open pits and Minyari deposit underground

- Minyari deposit accounts for 96% of total gold mining production
- Standard truck and shovel mining at three open pits
- Underground mining will use Modified Sub-Level Caving methods
- Minyari South open pit to act as box-cut for underground portal and decline

Minyari Dome Project open pit and conceptual underground mine design

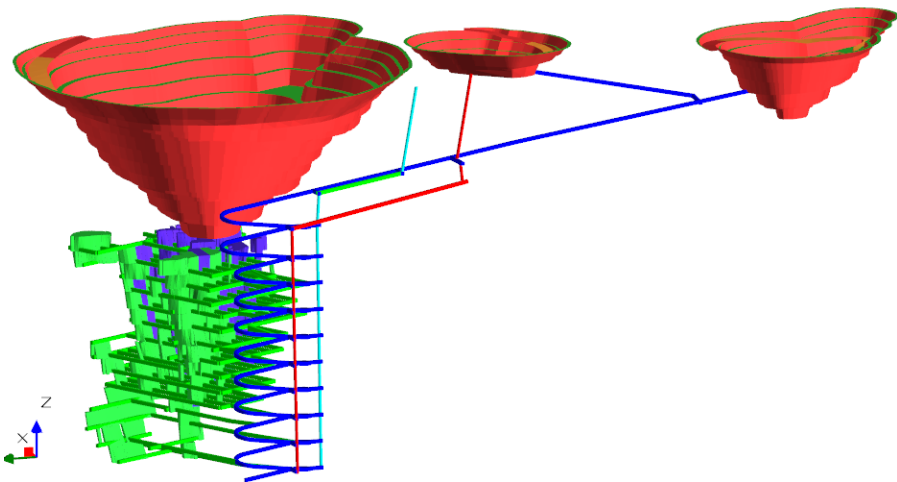

Minyari Dome Project conceptual configuration

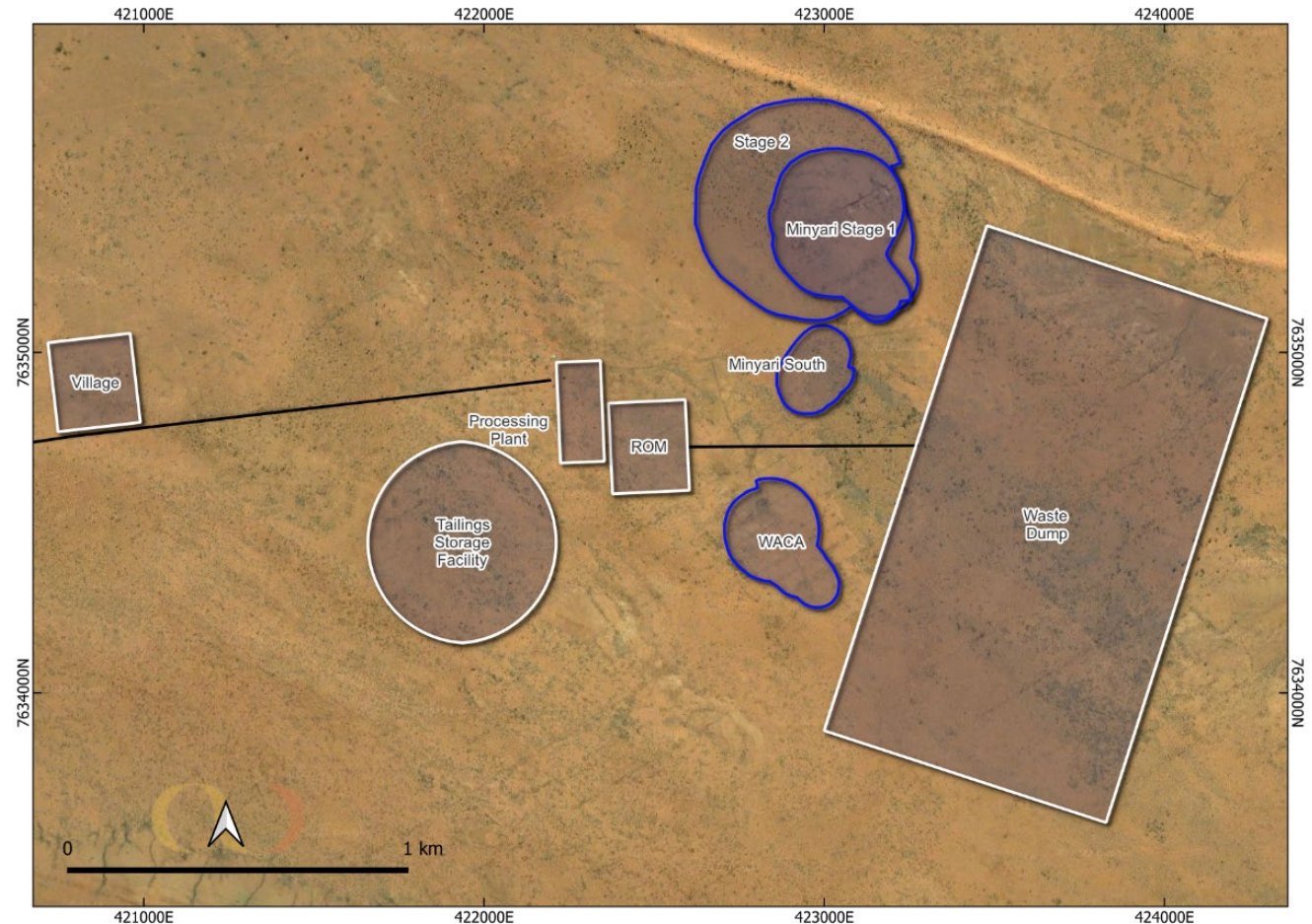



# MINING SCHEDULE

## Ore tonnage by Mineral Resource category and mining source

- 21.4 Mt of open pit and underground ore
- Average LOM grade of 1.6 g/t for 1.1 Moz gold
- 13.5 Mt ore from open pits (at a strip ratio of 5:1) and 7.9 Mt from underground
- Gold production sourced from 74% Indicated Resource (26% Inferred) for the three years of production spanning payback period
- For full 7+ year evaluation period, 72% sourced from Indicated Resource and 28% from Inferred Resource
- Open pit lower economic cut-off grade determined to be 0.30 g/t
- Underground lower economic cut-off grade determined to be 1.50 g/t

Minyari Dome Project Mined Ore Projection by mining method (kt)

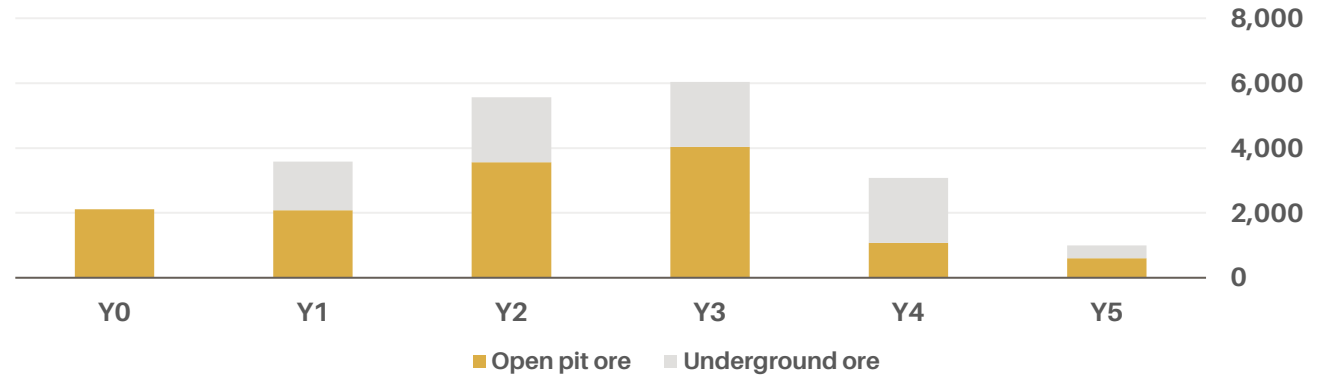

Minyari Dome Project Mined Ore Projection by resource category (kt)

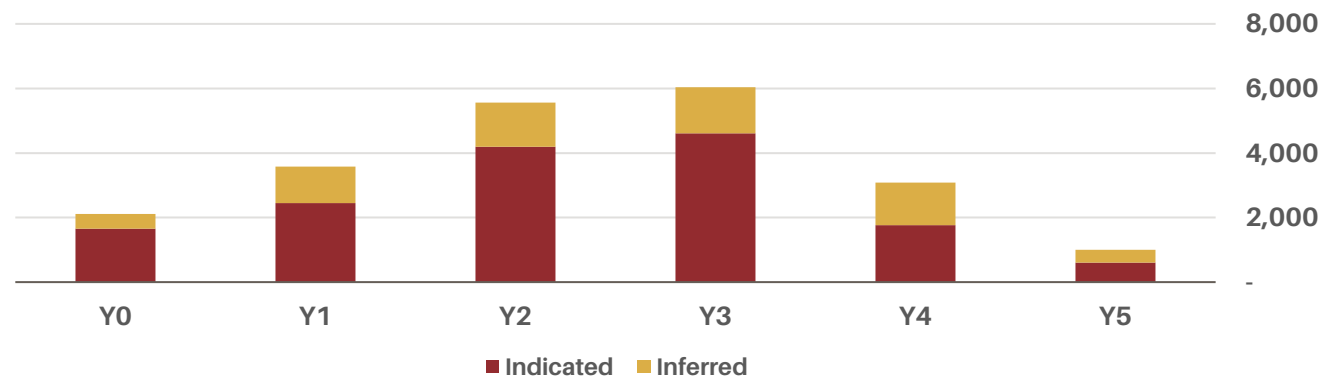



# CAPITAL COST ESTIMATE SUMMARY

Upfront capital requirement of A\$275M

## MAXIMISES GOLD OUNCES

during the first four years of production

## PREFERENTIAL PROCESSING

of high-grade ore stockpiles

## FLEXIBILITY REMAINS

pre-production mining can be reduced to lower upfront funding

### CAPITAL COST ESTIMATE (A\$M ± 35%)

Processing Plant (3 Mtpa CIL)	77.1
Contingency	7.7
Infrastructure - Process	33.0
EPCM	13.5
Reagents	2.3
Tailings Storage Facility (TSF)	8.5
Infrastructure - General/Other	25.3
Open Pit CAPEX	15.5
Underground CAPEX	24.4
<b>TOTAL CAPEX</b>	<b>207.3</b>
Pre-production Open Pit Mining	67.7
<b>TOTAL CAPEX + PRE-PRODUCTION MINING</b>	<b>275.0</b>

# OPERATING COST ESTIMATE SUMMARY

## Contractor mining at 3 Mtpa throughput

- Operating costs estimated for mining, processing and administration
- Consultants Snowden Optiro independently estimated open pit and underground mining costs based on a contractor strategy for equipment sizing considered relevant to each deposit and mining rates
- Haulage costs to the ROM and waste rock dump were included in overall operating costs
- Consultants Strategic Metallurgy undertook an independent assessment of the processing operating cost estimate at a throughput rate of 3 Mtpa

### OPERATING COST ESTIMATE (A\$/T ORE ± 35%)

Mining - open pit (13.5 Mt of ore)	25.3
Mining - underground (7.9 Mt of ore)	80.0
Processing	19.2
Administration	1.4
<b>TOTAL WEIGHTED AVERAGE LOM OPERATING COST (A\$/t)</b>	<b>70.0</b>

# JV AND FARM-IN PROJECT SUMMARY

## Citadel Joint Venture – Antipa 35% : Rio Tinto 65% (Rio earns 65% by sole funding A\$25M)

- ~1,200km<sup>2</sup> Citadel JV Project just 4km from Rio Tinto's Winu copper-gold-silver development project
- Existing combined Mineral Resource: 2.4Moz gold at 0.72 g/t, 162kt copper at 0.15% & 1.8Moz silver at 0.54 g/t
- Currently managed & operated by Rio Tinto
- Antipa utilising the dilute-down provision in JV agreement - Rio Tinto now sole funding CY2022 programme

## Wilki Project - A\$60M Newcrest Farm-in for up to 75% interest (currently AZY 100% : NCM 0%)

- ~2,200km<sup>2</sup> Antipa / Newcrest Farm-in Project (agreed 28 February 2020) comes to within 3km of Newcrest's Telfer gold-copper-silver mine & 22Mtpa plant & 9km of the Havieron gold-copper development project
- Initial A\$6M minimum exploration programme within 2 years managed by Antipa (achieved December 2021)
- Newcrest may earn a 51% interest in the Wilki Project by spending a further A\$10M within 5 years of commencement (i.e. 28 February 2025), to be managed at Newcrest's option
- Newcrest may earn up to 75% by sole funding a further A\$44M within 8 years of commencement (Total expenditure of A\$60M within 8 years of commencement of the Farm-in, i.e. by 28 February 2028)
- Managed & operated by Newcrest from July 2022
- Newcrest holds 9.9% interest in Antipa

## Paterson Project - A\$30M IGO Farm-in for up to 70% interest (currently AZY 100% : IGO 0%)

- ~1,550km<sup>2</sup> Antipa / IGO Farm-in Project (agreed 9 July 2020) comes within 23km of Telfer & 8km of Rio's Winu copper-gold-silver development project
- Initial A\$4M minimum exploration programme within 2.5 years managed by Antipa completed ahead of schedule in December 2021
- IGO may earn a 70% interest in the Paterson Project by spending a further A\$26M within 6.5 years of commencement, to be managed at IGO's option (Total expenditure of A\$30M within 6.5 years of commencement of the Farm-in, i.e. by January 2027)
- Upon joint venture formation, IGO shall free-carry Antipa to completion of a Feasibility Study
- Managed & operated by IGO from March 2022
- IGO holds 4.7% interest in Antipa

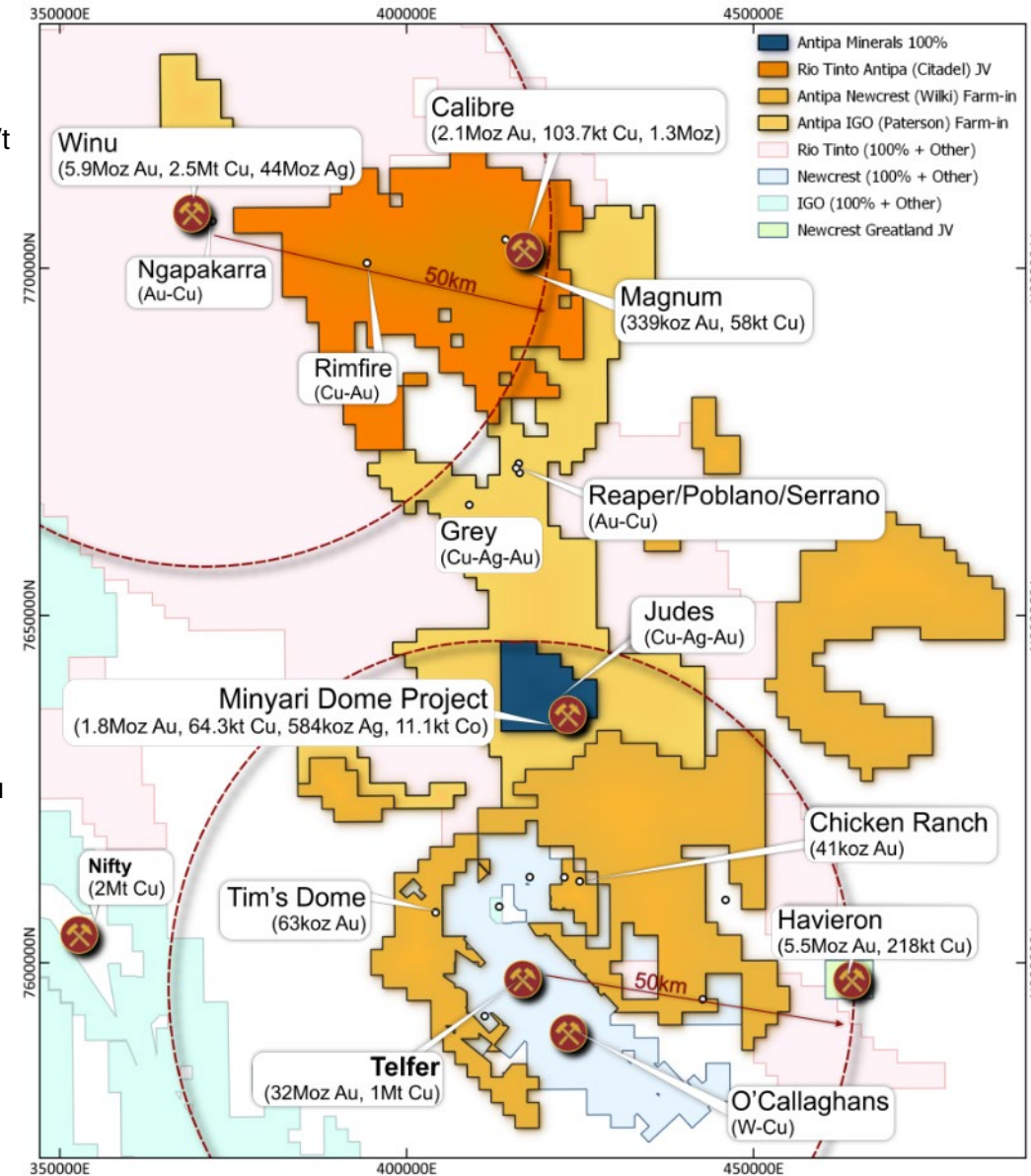



# SHALLOW DEPTH OF YOUNGER COVER - FIRST MOVER EXPLORATION AND DEVELOPMENT ADVANTAGE

**~50%**

OF ANTIPA TENEMENTS ARE UNDER LESS THAN

**20 metres**

OF COVER

**~80%**

OF ANTIPA TENEMENTS ARE UNDER LESS THAN

**80 metres**

OF COVER

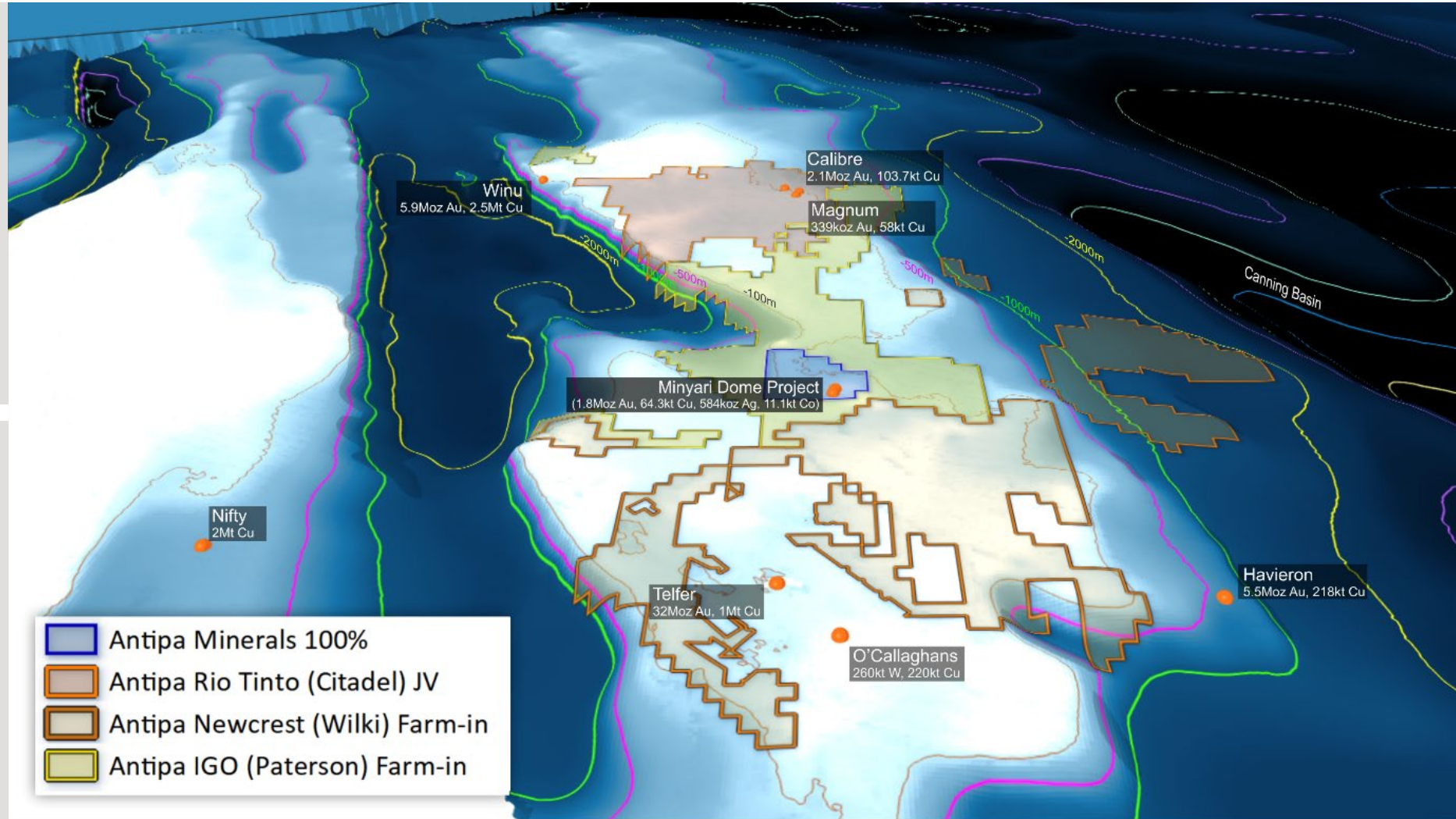



# CITADEL JV PROJECT (35% ANTIPA)

Geology and scale suggests substantial growth and development potential

## Calibre deposit (shown right)

- Inferred Mineral Resource 92Mt at 0.72 g/t gold, 0.11% copper and 0.46 g/t silver for 2.1Moz gold, 104kt copper and 1.3Moz silver
- 1.7km long, up to 480m thick and extends 500m down dip - open in most directions
- Just 45km from Winu

## Magnum deposit

- Just 1km from Calibre
- Inferred Mineral Resource 16.1Mt at 0.66 g/t gold, 0.36% copper and 0.99 g/t silver for 339koz gold, 58kt copper and 511koz silver
- 2km long, up to 600m thick and extends 600m down dip - open in most directions

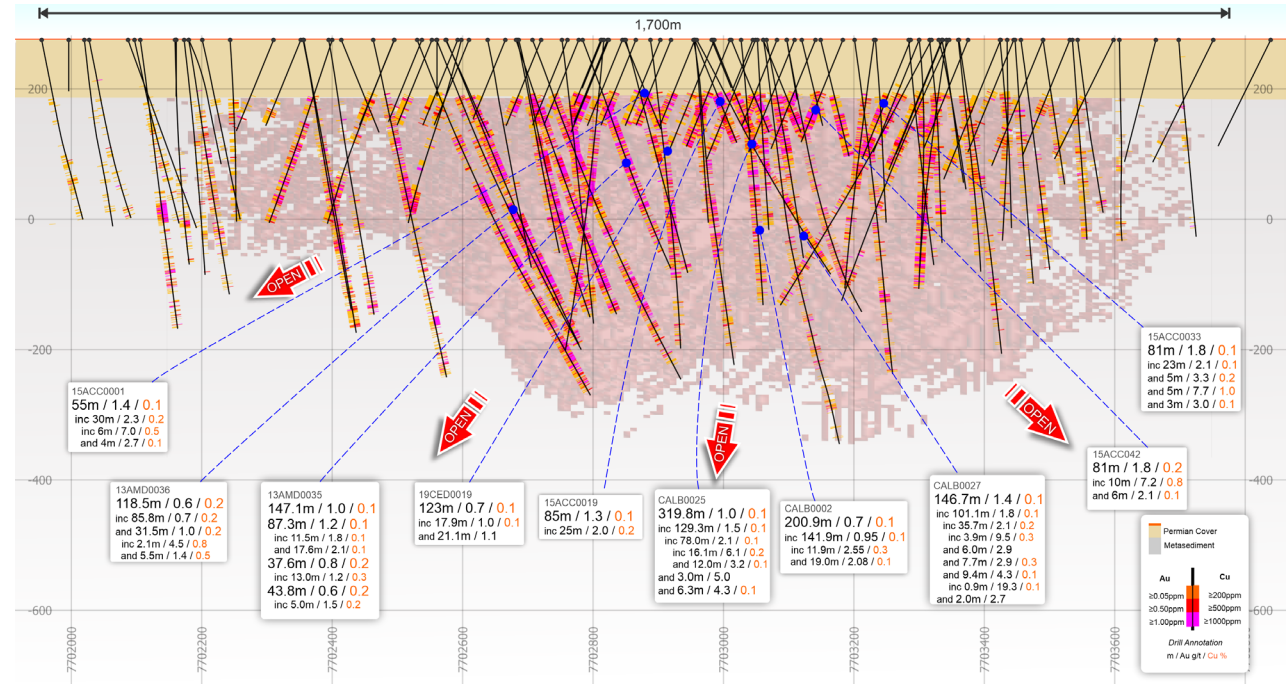

ONLY 80 METRES OF COVER AT BOTH DEPOSITS

# HAVIERON GOLD - COPPER DEPOSIT

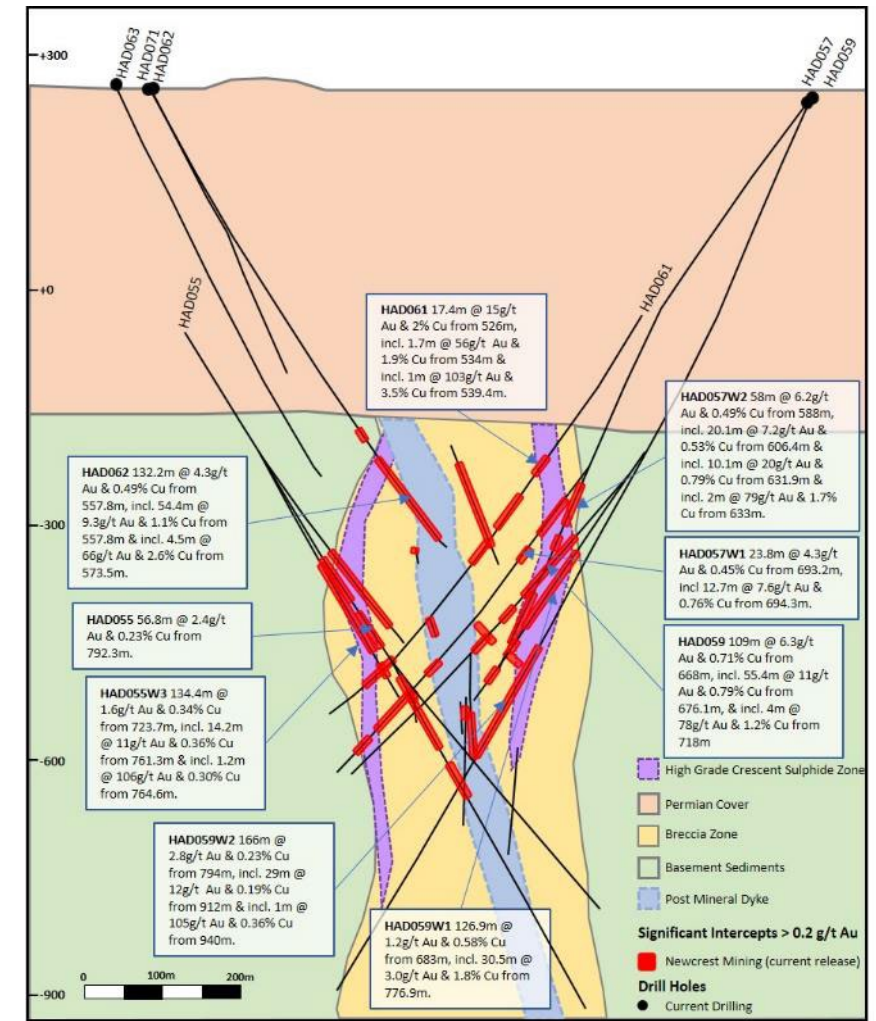
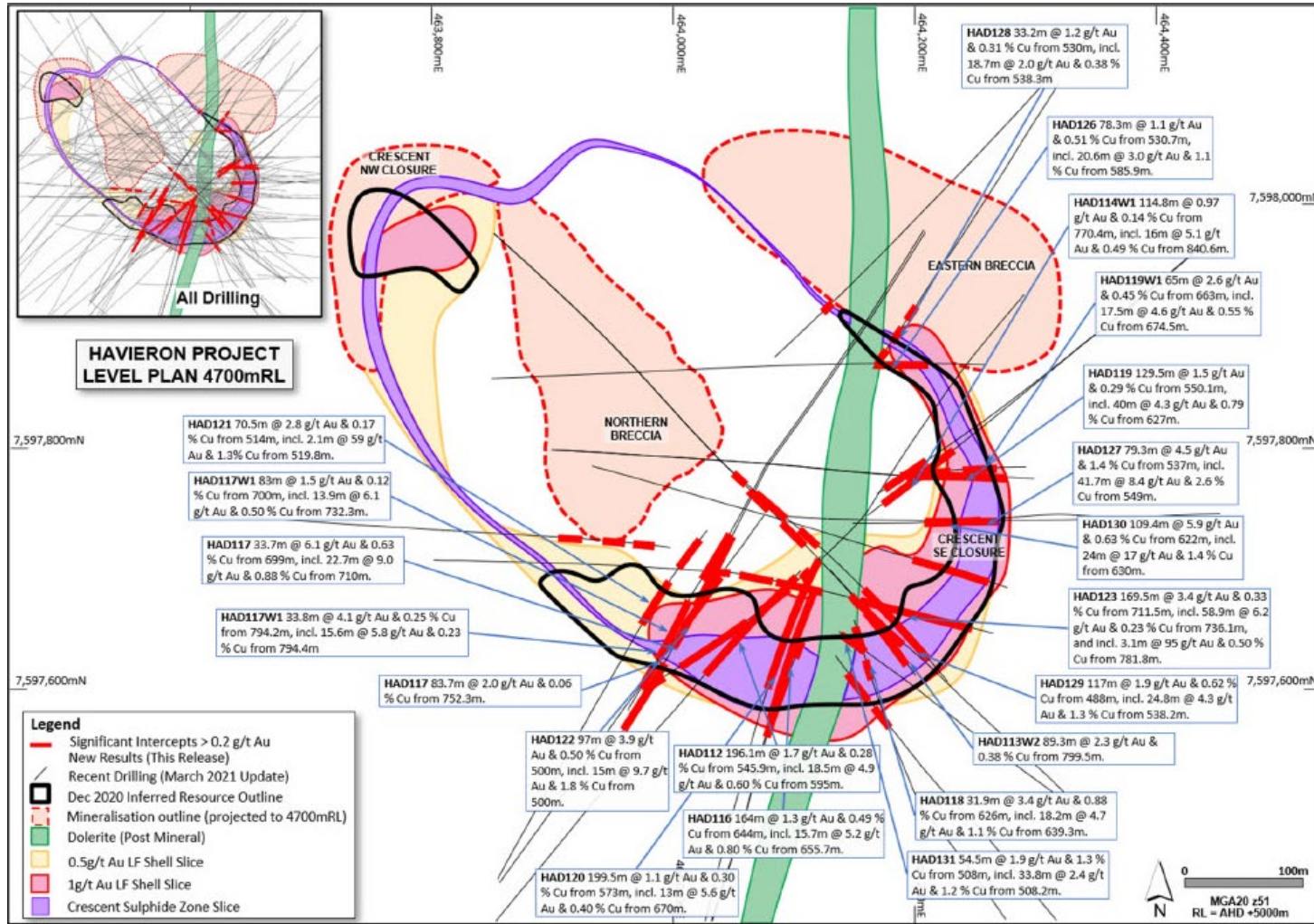

- Havieron deposit is the subject of a farm-in and joint venture agreement with Newcrest Mining Ltd able to earn up to a 70% joint venture interest via total expenditure of US\$65m (Refer to ASX and AIM releases 12 March 2019).
- Refer Greatland Gold plc's website ([www.greatlandgold.com](http://www.greatlandgold.com)) and London Stock Exchange (AIM: GGP) news releases ([www.londonstockexchange.com](http://www.londonstockexchange.com)) and Newcrest Mining Ltd ([www.newcrest.com.au](http://www.newcrest.com.au)) and Australian Stock Exchange (ASX: NCM) news releases ([www.asx.com.au](http://www.asx.com.au)).



# TELFER GOLD - COPPER - SILVER OPERATION

- Gold production gap

Newcrest Mining Ltd's (NCM) group production profile - Focus just on the orange area (i.e. Telfer+Havieron)<sup>1</sup>

Note NCM's diminishing production from the Telfer hub (35km from Minyari) from FY24 onwards<sup>1</sup>

Indicative base case gold production profile

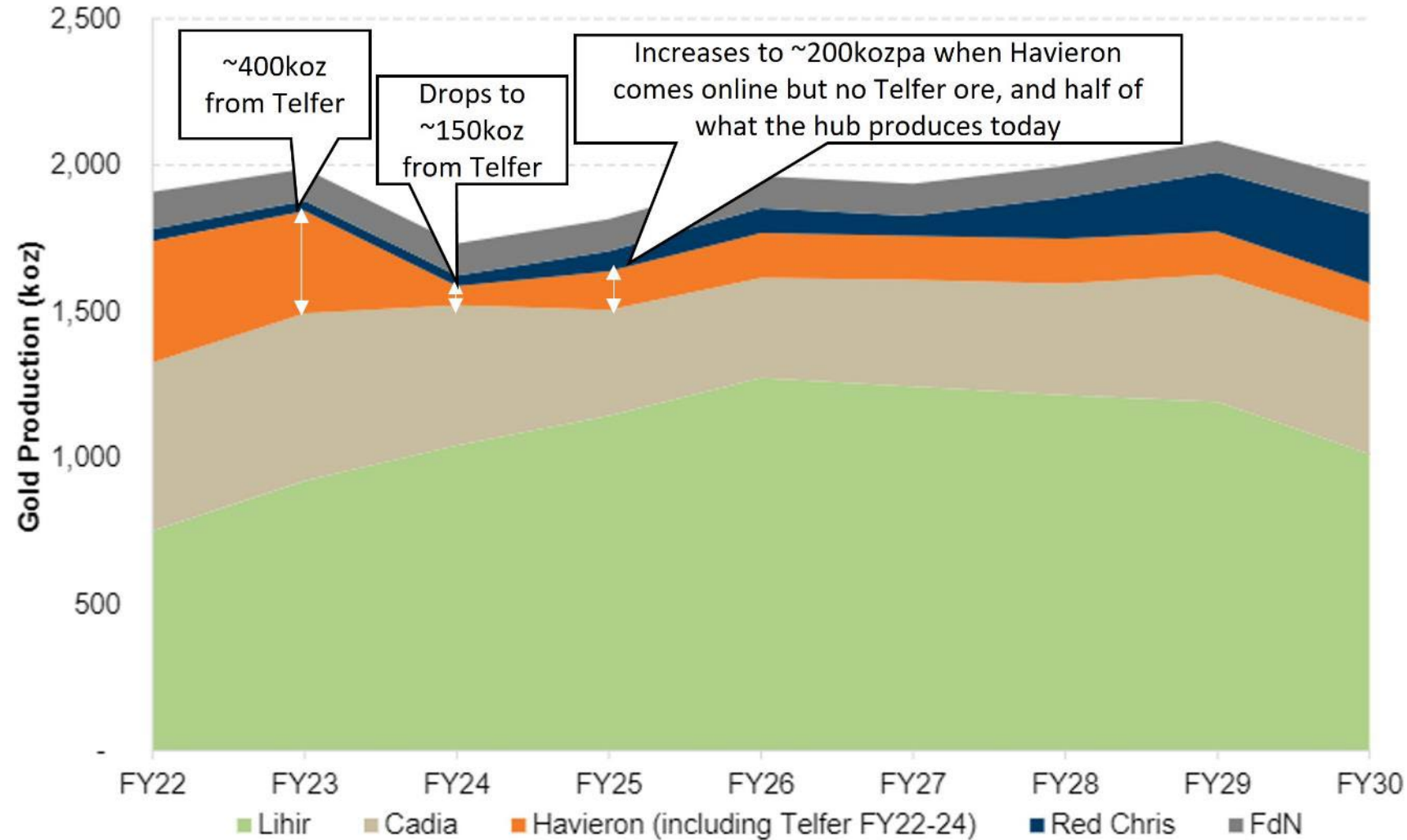

1. Sources: Graph from Newcrest public release report "Newcrest advances its global organic growth portfolio" 12 October 2021 available on Newcrest's website (www.newcrest.com) and Australian Securities Exchange (ASX:NCM) news releases (www.asx.com.au).

# MINERAL RESOURCE

## Minyari Dome

### Minyari Dome Project (100%)<sup>1</sup>

Deposit	Au cut-off	Category	Tonnes (Mt)	Au grade (g/t)	Cu grade (%)	Ag grade (g/t)	Co (%)	Au (oz)	Cu (t)	Ag (oz)	Co (t)
Minyari	0.5 Au	Indicated	15.00	1.17	0.19	0.54	0.04	567,000	27,800	259,600	5,930
Minyari	0.5 Au	Inferred	2.70	1.12	0.12	0.31	0.02	96,000	3,300	26,300	640
Minyari	1.5 Au	Indicated	4.40	2.30	0.26	0.83	0.03	328,000	11,400	118,400	1,450
Minyari	1.5 Au	Inferred	6.20	2.61	0.22	0.66	0.03	523,000	13,800	132,700	1,590
<b>Total Minyari</b>			<b>28.30</b>	<b>1.66</b>	<b>0.20</b>	<b>0.59</b>	<b>0.03</b>	<b>1,514,000</b>	<b>56,300</b>	<b>537,000</b>	<b>9,610</b>
WACA	0.5 Au	Indicated	1.69	0.97	0.11	0.17	0.02	52,000	1,900	9,400	310
WACA	0.5 Au	Inferred	1.54	1.02	0.12	0.18	0.02	51,000	1,800	9,100	300
WACA	1.5 Au	Inferred	1.63	1.69	0.11	0.17	0.03	89,000	1,900	9,000	560
<b>Total WACA</b>			<b>4.86</b>	<b>1.23</b>	<b>0.11</b>	<b>0.18</b>	<b>0.02</b>	<b>192,000</b>	<b>5,600</b>	<b>27,500</b>	<b>1,170</b>
Minyari South	0.5 Au	Inferred	0.15	4.51	0.56	1.04	0.05	22,000	900	5,100	80
<b>Total Minyari South</b>			<b>0.15</b>	<b>4.51</b>	<b>0.56</b>	<b>1.04</b>	<b>0.05</b>	<b>22,000</b>	<b>900</b>	<b>5,100</b>	<b>80</b>
Sundown	0.5 Au	Inferred	0.20	1.38	0.36	0.72	0.03	9,000	700	4,700	60
<b>Total Sundown</b>			<b>0.20</b>	<b>1.38</b>	<b>0.36</b>	<b>0.72</b>	<b>0.03</b>	<b>9,000</b>	<b>700</b>	<b>4,700</b>	<b>60</b>
WACA West	0.5 Au	Inferred	0.39	0.73	0.17	0.81	0.03	9,000	700	10,200	120
WACA West	1.5 Au	Inferred	0.01	0.86	0.50	0.05	0.01	304	55	17	1
<b>Total WACA West</b>			<b>0.40</b>	<b>0.73</b>	<b>0.18</b>	<b>0.79</b>	<b>0.03</b>	<b>9,304</b>	<b>755</b>	<b>10,217</b>	<b>121</b>
<b>Total Minyari Dome Project</b>			<b>33.92</b>	<b>1.60</b>	<b>0.19</b>	<b>0.54</b>	<b>0.03</b>	<b>1,746,304</b>	<b>64,255</b>	<b>584,517</b>	<b>11,041</b>

1. For full details of the 100% owned Minyari Dome Project Mineral Resources Estimate, please refer to ASX announcement dated 2 May 2022, "Minyari Dome Project Gold Resource Increases 250% to 1.8Moz".

# MINERAL RESOURCE

## Advanced exploration optionality

### Citadel Project (Antipa 35% and Rio Tinto 65% JV)

Deposit	Au cut-off	Category	Tonnes (Mt)	Au equiv. (g/t)	Au grade (g/t)	Cu grade (%)	Ag grade (g/t)	Au equiv. (Moz)	Au (Moz)	Cu (t)	Ag (Moz)
Calibre	0.5 Au	Inferred	92	0.92	0.72	0.11	0.46	2.7	2.10	104,000	1.3
Magnum	0.5 Au	Inferred	16	-	0.70	0.37	1.00	-	0.34	58,000	0.5
<b>Total Citadel Project (100% basis)</b>			<b>108</b>	<b>-</b>	<b>0.72</b>	<b>0.15</b>	<b>0.54</b>	<b>2.7</b>	<b>2.44</b>	<b>162,000</b>	<b>1.8</b>

### Wilki Project (100%)

Deposit	Au cut-off	Category	Tonnes (Mt)	AU grade (g/t)	Cu grade (%)	Ag grade (g/t)	Co (ppm)	Au (oz)	Cu (t)	Ag (oz)	Co (t)
Chicken Ranch	0.5 Au	Inferred	0.8	1.6				40,300			
Tims Dome	0.5 Au	Inferred	1.8	1.1				63,200			
<b>Total Wilki Project</b>			<b>2.4</b>	<b>1.3</b>				<b>103,500</b>			

#### Competent Persons Statement – Exploration Results

The information in this document that relates to Exploration Results is based on and fairly represents information and supporting documentation compiled by Mr Roger Mason, a Competent Person who is a Member of The Australasian Institute of Mining and Metallurgy. Mr Mason is a full-time employee of the Company. Mr Mason is the Managing Director of Antipa Minerals Limited, is a substantial shareholder of the Company and is an option holder of the Company. Mr Mason has sufficient experience relevant to the style of mineralisation and type of deposit under consideration and to the activity being undertaken to qualify as a Competent Person as defined in the 2012 Edition of the 'Australasian Code for Reporting of Exploration Results, Mineral Resources and Ore Reserves'. The Company confirms that the form and context in which the Competent Person's findings are presented have not been materially modified from the original market announcements, all of which are available to view on [www.antipaminerals.com.au](http://www.antipaminerals.com.au) and [www.asx.com.au](http://www.asx.com.au). Mr Mason, whose details are set out above, was the Competent Person in respect of the Exploration Results in these original market announcements.

#### Competent Persons Statement – Mineral Resource Estimations for the Minyari Dome Project Deposits, Calibre Deposit, Magnum Deposit and Chicken Ranch Area Deposits and Tim's Dome Deposit

The information in this document that relates to the estimation and reporting of the Minyari Dome Project deposits Mineral Resources is extracted from the report entitled "Minyari Dome Project Gold Resource Increases 250% to 1.8 Moz" created on 2 May 2022 with Competent Persons Ian Glacken, Jane Levett, Susan Havlin and Victoria Lawns, the Tim's Dome and Chicken Ranch deposits Mineral Resources is extracted from the report entitled "Chicken Ranch and Tims Dome Maiden Mineral Resources" created on 13 May 2019 with Competent Person Shaun Searle, the Calibre deposit Mineral Resource information is extracted from the report entitled "Calibre Gold Resource Increases 62% to 2.1 Million Ounces" created on 17 May 2021 with Competent Person Ian Glacken, and the Magnum deposit Mineral Resource information is extracted from the report entitled "Calibre and Magnum Deposit Mineral Resource JORC 2012 Updates" created on 23 February 2015 with Competent Person Patrick Adams, all of which are available to view on [www.antipaminerals.com.au](http://www.antipaminerals.com.au) and [www.asx.com.au](http://www.asx.com.au). The Company confirms that it is not aware of any new information or data that materially affects the information included in the original market announcements and that all material assumptions and technical parameters underpinning the estimates in the relevant original market announcements continue to apply and have not materially changed. The Company confirms that the form and context in which the Competent Person's findings are presented have not been materially modified from the original market announcements.

#### Scoping Study Information:

The information in this document that relates directly to the 2022 Minyari Dome Project Scoping Study report was compiled by Mr. Roger Mason, a Competent Person who is a Member of The Australasian Institute of Mining and Metallurgy. Mr. Mason is employed as Managing Director of Antipa Minerals and has sufficient experience in the development of gold projects from the studies phase to the operational phase and consents to the inclusion in the report of the matters based on his information in the form and context in which it appears.