



# TECHNICAL STUDY AFFIRMS CAPANDA AS ONE OF THE MOST PROMISING GREEN AMMONIA PROJECTS GLOBALLY

**ASX Announcement | 11<sup>th</sup> April 2023**

**Minbos Resources Limited (ASX:MNB) (“Minbos” or “the Company”)** is pleased to announce the results of the Capanda Green Ammonia Project Technical Study (the “**Study**”).

The main purpose of the Study was to determine the technical feasibility of the Capanda Green Ammonia Project (the “**Project**”), including defining all the required process units, plant configuration based on the available renewable electricity and estimate the CAPEX and OPEX for the Project to a Class 5 AACE R18-97 level.

The basis of the Study was the utilization of 200MW of hydroelectric power available to Minbos under its MOU with the Angolan network operator RNT<sup>1</sup> from the Capanda Hydroelectric Dam (Figure. 1) to produce Green Ammonia of which 50% would be used to produce Calcium Ammonium Nitrate fertilizer and 50% to produce Ammonium Nitrate for the mining sector.

The Study defines a carbon-free facility, avoiding the use of natural gas or any other carbon-based raw material, through the production of Green Hydrogen obtained through using water electrolysis, and nitrogen obtained from the air using an air separation unit, to produce Green Ammonia, the basis of the final products.

The Study was completed by Minbos’ technology partner, Stamicarbon, the innovation and license company of the Maire Tecnimont Group S.p.A. (MT.MI). With more than 75 years’ experience, having developed more than 260 urea plants, Stamicarbon is a trailblazing specialist in the Green Ammonia industry.

<sup>1</sup> MNB ASX Announcement: Historic Green Energy MOU Signed for the Capanda Green Ammonia Project (14<sup>th</sup> December 2022)

## CAUTIONARY STATEMENT

---

The Study referred to in this announcement is a Technical Feasibility of the Capanda Green Ammonia Project based on the power available under the RNT MOU to supply local agriculture users and Nitrogen/Phosphate/Potassium (NPK) blenders.

It is a preliminary technical and economic study of the potential viability of the Project. Further evaluation work and appropriate studies are required before Minbos will be in a position to provide any assurance of an economic development case.

The Study is based on the material assumptions outlined below. These include assumptions about the availability of funding. While Minbos considers all of the material assumptions to be based on reasonable grounds, there is no certainty that they will prove to be correct or that the range of outcomes indicated by the Study will be achieved.

Investors should note that there is no certainty that Minbos will be able to raise the amount of funding to develop the Project when needed. It is also possible that such funding may only be available on terms that may be dilutive to or otherwise affect the value of Minbos' existing shares.

It is also possible that Minbos could pursue other 'value realisation' strategies such as a sale, partial sale or joint venture of the Project. If it does, this could materially reduce Minbos' proportionate ownership of the Project.

Given the uncertainties involved, investors should not make any investment decisions based solely on the results of the Study.

## STUDY ASSUMPTIONS

---

The Study is based on the full utilization of the power available under the RNT MOU. 200MW of carbon-free electricity is supported with one of the most competitive price schemes ever - 100MW at US\$0.004 per kw hour for 5 years then US\$0.008 per kw hour for 20 years and a second 100MW at US\$0.015 per kw hour for 25 years. The CAPEX and OPEX are derived from the utilisation and pricing of the power.

- Stamicarbon determined 200MW of available power would power 172MW of average rated equipment capacity and support the production of ~320 Metric Tonnes Per Day (MTPD) of Green Ammonia to produce the following finished products:
  - ~730 MTPD of Low-Density Ammonium Nitrate (LDAN) for use in mining explosives.
  - ~980 MTPD of Calcium Ammonium Nitrate (CAN) for use in the local fertilizer industry.

- The major equipment required to produce Ammonia, LDAN and CAN and fully utilize the available power comprises an Electrolyser unit, Nitrogen Generation unit, Ammonia unit, Nitric Acid, Ammonia Nitrate Solution, CAN and LDAN finishing units. Stamicarbon estimated plant and equipment CAPEX of EUR 365 M - EUR 496 M (midpoint EUR 432M). Further details on this are set out below.
- OPEX costs largely are driven by the price of electricity<sup>2</sup>. OPEX has been estimated and presented using the average power tariff and the optionality of the lower tariffs as reflected in the RNT MOU:

**TABLE 1: OPERATING COST SENSITIVITY TO POWER PRICE**

Electricity Pricing (US\$/MW.hr)	CAN (\$/t)			LDAN (\$/t)		
	Low	Mid	High	Low	Mid	High
4.00	98	115	132	112	132	152
8.00	114	134	154	128	151	174
11.5 Average	128	151	174	142	167	192

- The Electrolyser Unit makes up approximately 33% of the CAPEX and 92% of the OPEX.

The Study Cost estimate was carried out in accordance with Class 5 Cost Estimate as per AACE International recommended practice.

The level of information developed during the study and previous experience, the range of accuracy of the estimate is: +/- 35%.

## STUDY PURPOSE

The primary purpose of the Study was to determine the Technical Feasibility of the Capanda Green Ammonia Project based on the power available under the RNT MOU.

The power data from the Study will be used to work with RNT to optimise the load curve to match the Capanda generation and substation infrastructure.

The Study will serve to further discussions with potential partners interested in supplying Ammonium Nitrate to the Western Copper Belt mines in Zambia and the Democratic Republic of Congo.

<sup>2</sup> Note: OPEX Cost are excluding capital cost per tonne product.

The assumed the production of both CAN fertilizer and LDAN explosive product for the purposes of full engagement with the relevant government ministries but will be used to simplify and/or refined the product mix in subsequent studies.

The Stamicarbon work will be used to identify and resolve any gaps ahead of defining the scope of a Pre-Feasibility Study, which will be the next step in the Project development roadmap.

## **ADVANTAGES AND OPPORTUNITIES**

---

Stamicarbon noted the unique advantages of Capanda Green Ammonia Project:

- Hydropower is already operational and available at one of the most competitive tariffs available to any green ammonia project in the world.
- The availability of high-quality water minimizes the capital and operating costs compared to saline groundwater or even seawater.
- Most importantly, the Project is located close to a growing market for fertilizer where the project scope elegantly matches the agricultural aspirations of the Angolan President, and the existing explosives market in the Western Copper Belt which already consumes full proposed scope of the Project and is projected to grow rapidly.

Capturing the 'African Inland Premium' for nitrogen fertilizer and explosives products is one of the biggest opportunities for the Project.

Capanda fertilizers, anticipated to be produced from the Project, competing with FOB fertilizer products from north and west Africa will not bear the cost of marine freight and insurance, customs and port fees, product packaging and 300km of land transport.

Capanda explosives, anticipated to be produced from the Project, competing with alternative explosive products from South Africa have a land transport advantage of 1000km and additional marine freight and port cost advantages over seaborne competition.

The Study refers to the above advantages as the 'African Inland Premium'.

The Study highlighted options to refine the product mix to best capture the African Inland Premium. Preliminary discussions with government suggest it might be possible to produce High Density Ammonium Nitrate which can serve as both a fertilizer and feedstock for emulsion explosives which make up the biggest share of the mining market. This product could enhance the African Inland Premium and also reduce the operating costs by eliminating one finishing plant and the need to add dolomite to the process.

Third parties have shown interest in becoming a Build Own Operate (BOO) supplier of Hydrogen to the Ammonia plant. Commercially this would remove the major capex component and enhance returns by preserving most of the margins.

By-product opportunities exist within the Nitrogen Plant and the future studies are anticipated to consider the option to produce oxygen and argon for the local market.

The current Study assumes Alkaline Electrolysers will be employed in the Electrolyser Plant. In the future, the option to switch to Solid Oxide Electrolysers will be considered. The emerging Solid Oxide Electrolysers are 30% more efficient than the established alkaline technology and, while they are commercially available, they are not yet widely deployed.

### **Commenting on the Study, Stamicarbon B.V. Director of Technology Licensing, David Franz:**

***“We are pleased to assist Minbos in the completion of another phase of their feasibility work on the Capanda Green Ammonia Project in Angola. Stamicarbon has evaluated technical and economic aspects of this innovative project to assist Minbos in taking the project further.*”**

*As expected, the extremely low committed renewable energy cost that the project will enjoy is a key driver, as is the dual-market redundancy of serving both the mining sector in the Democratic Republic of the Congo and Zambia as well as the growing agricultural sector in Angola with Ammonium Nitrate (AN) and Calcium Ammonium Nitrate (CAN) respectively.*

*This is a well-conceived project from both a technical conceptual basis as well from an economic standpoint. We are honoured to be involved and will continue to support to see it come to reality.”*

### **Commenting on the Study, Minbos CEO Lindsay Reed:**

***“The Company is developing a project with a strong competitive advantage, including competitive and installed green electricity pricing, a genuinely zero-carbon project, high quality water and proximity to markets, which is now recognised as the gold standard for viable Green Hydrogen-Ammonia Projects.*”**

*One of Capanda’s biggest opportunities is to capture ~\$200/t African Inland Premium for nitrogen products.*

*The Company looks forward to progressing to its pre-feasibility study with significant international interest from potential project partners. We will continue to develop projects that not only grow value for shareholders, but continue to build the country of Angola, from the ground up.”*



*Figure 1 - Capanda Hydroelectric Dam, the Project site for Minbos' Green Ammonia Project and source of the 100% emissions-free green electricity.*

## **GREEN AMMONIA NEXT STEPS**

- Commence work on a pre-feasibility study, with timeline for completion to be announced in the coming weeks.
- The Company has begun offtake and financing discussions with several high-quality project partners and debt providers.
- Market feasibility study to be undertaken on opportunities not only in Angola, but to take advantage of the recently announced Lobito Corridor rail link (Angola, Democratic Republic of Congo and Zambia).
- Negotiations to be finalised to secure plant site for the Capanda Green Ammonia Project.

## **TECHNICAL STUDY TECHNICAL STUDY: INTRODUCTION**

Minbos selected Stamicarbon to conduct a Technical Study to determine the most suitable plant configuration to produce Green Nitrates starting from 100% renewable electricity.

The renewable electricity will be supplied by the Capanda Hydroelectric Dam, in the state of Malanje, Angola. Minbos has signed a MoU where it has been granted approximately 200MWh of power for a 25-year period with one of the most competitive price schemes ever seen in a commercial environment.

The Study anticipates that the ultimate use of the Green Nitrates will be split into two products:

- 50% to be produced as Calcium Ammonium Nitrate (CAN) to serve the local fertilizer market in Angola, which currently is very small due to fertilizers supply unavailability.
- 50% to be produced as Low-Density Ammonium Nitrate (LDAN) to supply the mining industry to its neighbours, Zambia and the Democratic Republic of Congo.

Stamicarbon is a worldwide leading technology licensing company and has been selected by Minbos to carry out the Study which includes the integration of its Stami Green Ammonia and Nitric Acid technologies, including the Nitrates finishing technologies with its partner INCRO.

Given the experience Stamicarbon has in the integration of industrial projects, the Study also includes the integration of Electrolysers unit, Nitrogen generation unit, as well as off sites facilities. The goal of the study was to estimate the Capital Expenditures (CAPEX) with a Class 5 AACE R18-97 accuracy.

## OVERVIEW

---

This Study conducted by Stamicarbon has determined the main processes production unit's configuration for a Green Ammonium Nitrate Production Complex. The Electric Energy price scheme for the project is as follows:

- Initial 100MW at US\$0.004 per kw hour for 5 years then US\$0.008 per kw hour for 20 years.
- Subsequent 100MW at US\$0.015 per kw hour for 25 years.

The Study includes the production of Green Hydrogen using water electrolysis to produce green ammonia, nitric acid and solid ammonium nitrates with a final production mix of 50% Calcium Ammonium Nitrate (CAN) and 50% Low-Density Ammonium Nitrate (LDAN) explosive grade.

The main purposes of the Study have been:

- To determine the technical feasibility of the Project defining all the required process units.

- To size and optimize the entire plant configuration (Fig. 2) based on the available green electricity supply indicated by Minbos, corresponding to ~200 MWh.
- To determine the required CAPEX for the plant Class 5 AACE R18-97.
- To estimate an initial OPEX for the Project.

## CAPANDA HYDROELECTRIC DAM AND PROJECT LOCATION

The Capanda Green Ammonia Project plant site is proposed in the Capanda Industrial Complex in the province of Malange Angola, within 15km's of the Capanda Hydropower plant (Figure 2.)

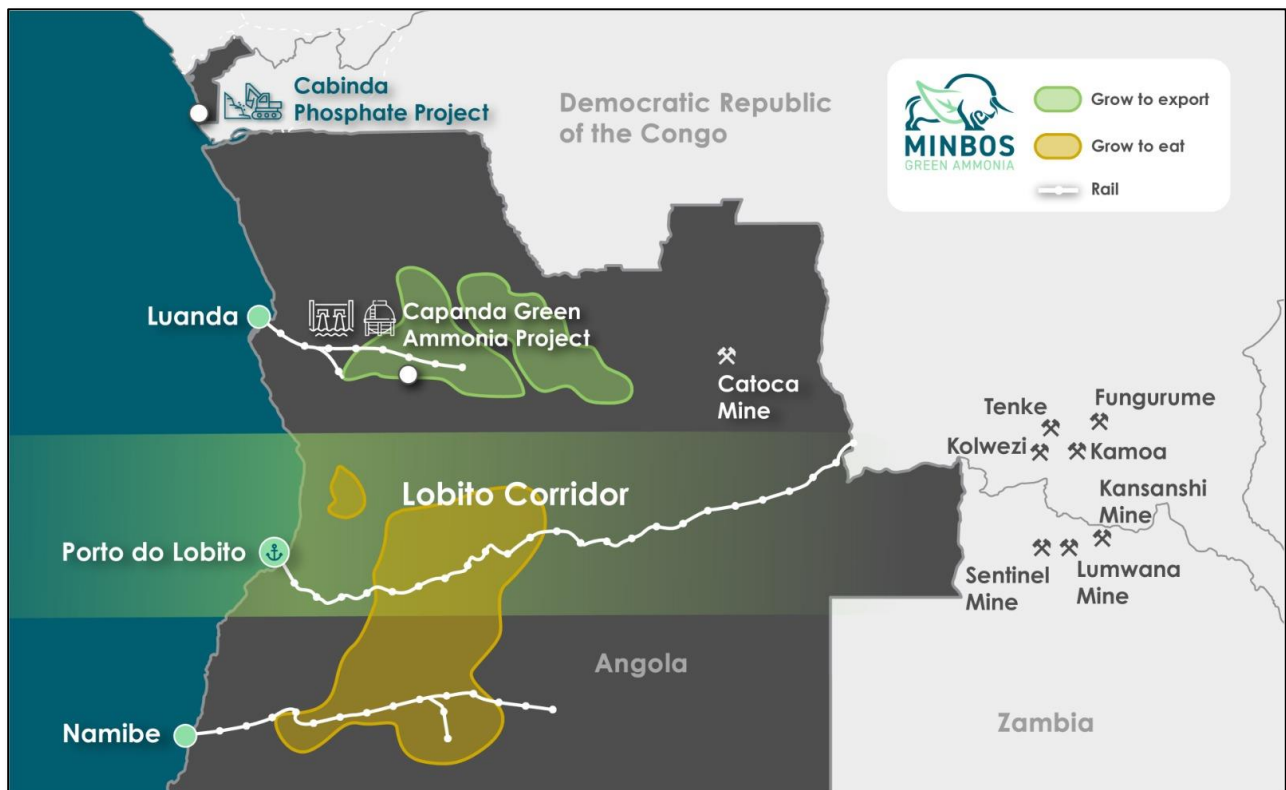
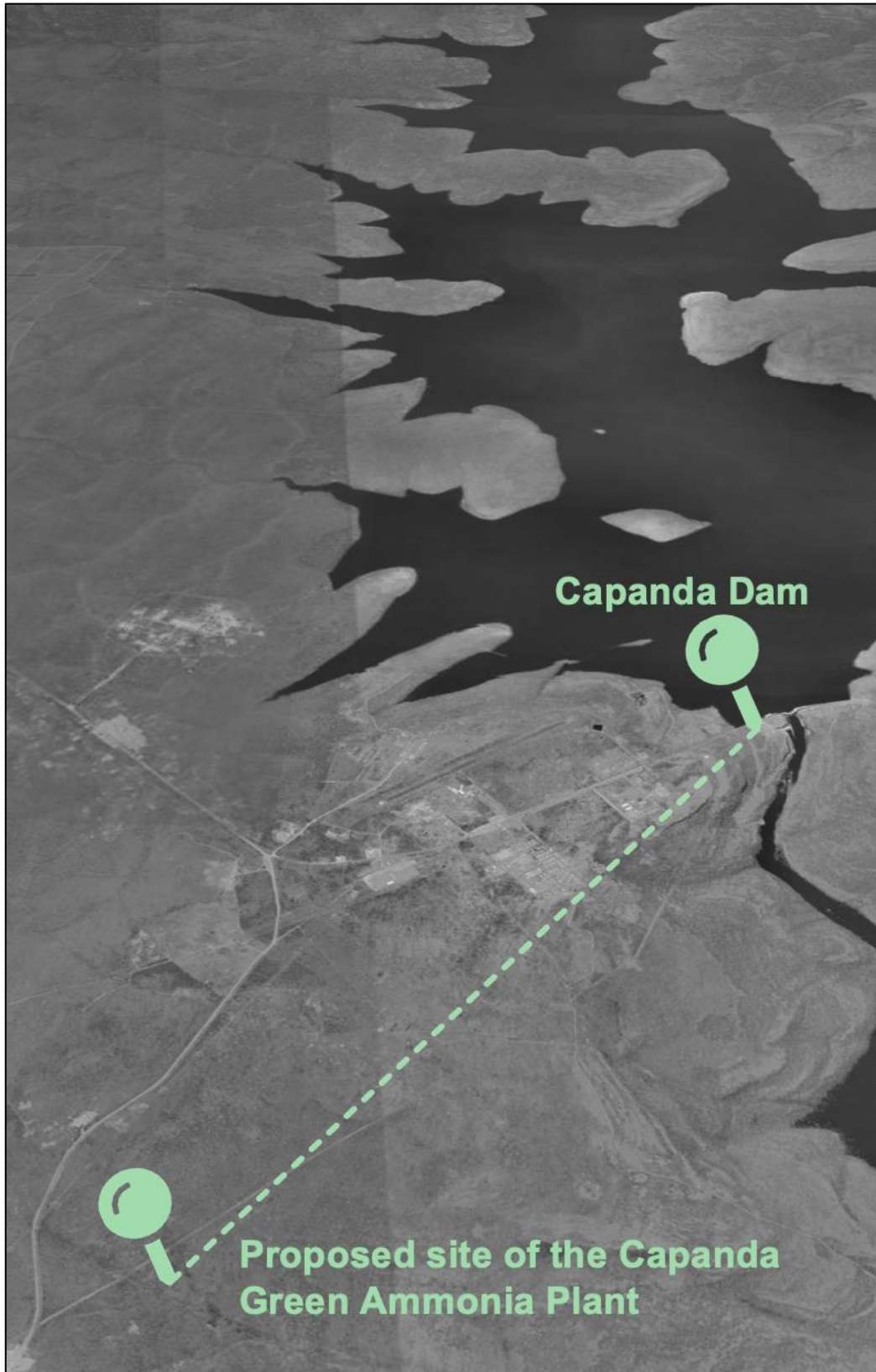

Figure 2 – Project location of the Capanda Green Ammonia Project

Located on the Kwanza River, in the Malange Province of Angola, the Capanda Hydropower Plant has installed capacity to 520 MW, generating power by utilising four turbines and 130 MW (170,000 hp) each.

The Project plant site is proposed to be located within 15 km of the Capanda Hydroelectric Dam (Figure. 3), along an existing transmission corridor where the Company plans to its Green Ammonia Plant and within trucking distance to the Malange growing corridor and major regional mining projects, reducing transport costs and ensuring the Project's 'African Inland Premium Advantage' cost is maintained.





*Figure 3 – Proposed site of the Capanda Green Ammonia Plant*

## TECHNICAL SCOPE

---

The basis for the design of the new Green Ammonium Nitrate Plant will comprise of the following main process plants (capacities hereunder are provided as preliminary based on maximum energy consumption of 200MWh):

- Green Hydrogen Generation unit by alkaline water electrolysis (AWE) with a capacity of 149MW.
- Nitrogen production by Nitrogen Generation Unit (NGU, with a capacity of 270MTPD).
- Ammonia Synthesis with capacity of ~320 MTPD.
- Nitric Acid process with capacity of ~580 MTPD.
- Calcium Ammonium Nitrate (CAN) ~980 MTPD and Low-Density Ammonium Nitrate (LDAN) ~730 MTPD.
- Ammonia Nitrate Finishing Section at 980 MTPD (50% Fertilizer and 50% Explosive grade).
- Utilities for the overall complex, including storage and truck loading facilities for CAN and LDAN.

The plant is anticipated to produce ~320 MTPD of Green Ammonia with a turn-down rate of 70% (Fig. 3). The entire plant availability considered is 96% minimum (350 days per year) at nominal capacity, excluding turnarounds.

Mono pressure nitric acid plant producing 60 wt. % nitric acid. Turn down capacity of the nitric acid plant is 70%.

LDAN and CAN plants have a normal turn-down ratio of 40-50% and normal working hours are referred to 330-335 days of operation and basically continuous operation, excluding cleaning and maintenance scheduled shutdowns.

Ammonium nitrate solution section will be common for both Ammonia Nitrate (AN) grade, whereas solids section will differ, as LDAN will be produced in a prilling tower while CAN in a granulation drum, but they will share some common equipment, mainly in final product and scrubbing equipment in order to optimize the overall plant Capex.

## PROCESS PLANT OVERVIEW

---

The Plant process arrangement consists of the following units:

- Nitrogen Generation Unit
- Green Hydrogen Production Unit
- Hydrogen Compression
- Green Ammonia Unit
- Nitric Acid Unit
- Ammonium Nitrate Solution Section
- AN Prilling and Granulation Sections
- Dolomite (Calcium carbonate and magnesium) Milling Section

A block diagram of the flowsheet is shown below in Figure 4.

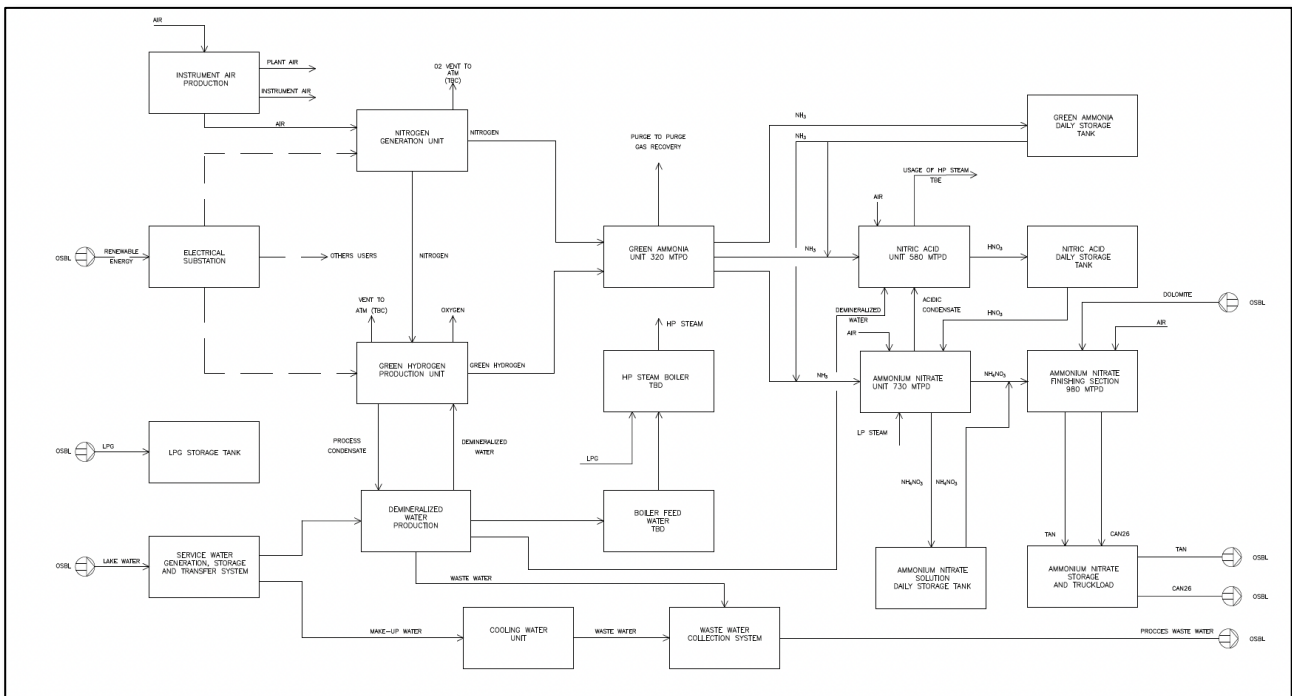

Figure 4 – Capanda Green Ammonia Project design flowsheet with various production and energy units, including hydrogen and nitric acid units.

## Nitrogen Generation Unit

The nitrogen production is based on a cryogenic process to separate nitrogen and oxygen from compressed air. The unit will be fed with dry compressed air from instrument and plant air.

In the nitrogen generation package, dry compressed air is distillate in order to produce simultaneously gaseous and liquid nitrogen. Gaseous nitrogen feed the downstream

Ammonia Synthesis Unit and the nitrogen distribution header for purging requirement of equipment, for blanketing, for utility stations, for flare headers purging in order to cover the nitrogen continuous and intermittent demand of the Fertilizer Complex.

## Hydrogen Production

The function of this unit is to produce Pure Hydrogen at the required rate, by the electrolysis of Water. An electrolysis cell uses direct current electric supply to split Water into Hydrogen and Oxygen.

The electrolysis unit is a standard and well proven solution that gives a stable and reliable production, with high production efficiency and limited power losses and allows to produce gas directly at high pressure ready for further processing. The system structure is modular and flexible design for both electrical and control systems. Multiple electrolyser trains of hydrogen are foreseen to meet the required capacity. Each train is composed of:

- a) Two electrolyzer stacks with common rectifier system.
- b) Two Lye Coolers
- c) Two Lye-gas Separators
- d) One O<sub>2</sub> Cooler and one H<sub>2</sub> Cooler
- e) One gas condensate KO drum for O<sub>2</sub> and one for H<sub>2</sub>

Each electrolyser train is supplied and controlled independently in order to ensure maximum production and maintenance flexibility minimizing the production downtime.

## Green Ammonia Unit

Synthesis of Ammonia is performed by the well-established Haber Bosch process. Ammonia is produced when 1 mole nitrogen reacts with 3 mole hydrogen to give 2 moles of ammonia under pressure and in the presence of a catalyst.

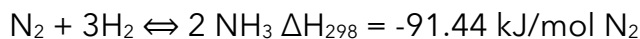

Production of ammonia is an exothermic reaction, meaning heat is produced as product of the reaction, as shown in the reaction equation above. Heat removal is thus important to operate at an optimal distance from equilibrium as well as to prevent undesired high temperatures in the converter. The equilibrium between products and reactants at reaction conditions does not allow for full conversion of the reactants, thus requiring a recycle of hydrogen and nitrogen back to the converter, after product separation. A simplified Block-Flow Diagram of the process is shown below (Figure 5).

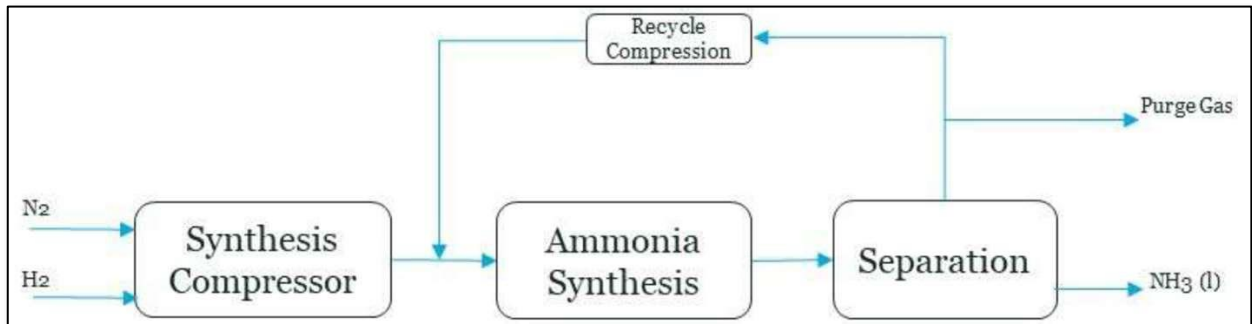

Figure 5: Block Diagram for Heber-Bosh Ammonia Production

## Nitric Acid Production

There are three primary steps to produce Nitric Acid:

- Catalytic oxidation of ammonia to yield nitrogen monoxide.
- Oxidation of nitrogen monoxide to yield oxides of nitrogen.
- Absorption of oxides of nitrogen in water to yield nitric acid.

Liquid nitrogen is first vaporized and converted into the gaseous state and then it is passed through a filter in order to remove any impurities present in the raw material. The air is compressed and passed through a heat exchanger in order to increase its temperature and then the preheated compressed air is passed through a filter to remove impurities if any. Air and ammonia are mixed and passed to a converter containing a Platinum-Rhodium catalysts (Figure 6).

The ammonia is catalytically oxidized in presence of oxygen to primarily yield nitrogen monoxide. The by products which are formed are water and nitrogen. Enough oxygen remains in the output of the converter for the next chemical reaction steps to occur further down the line.

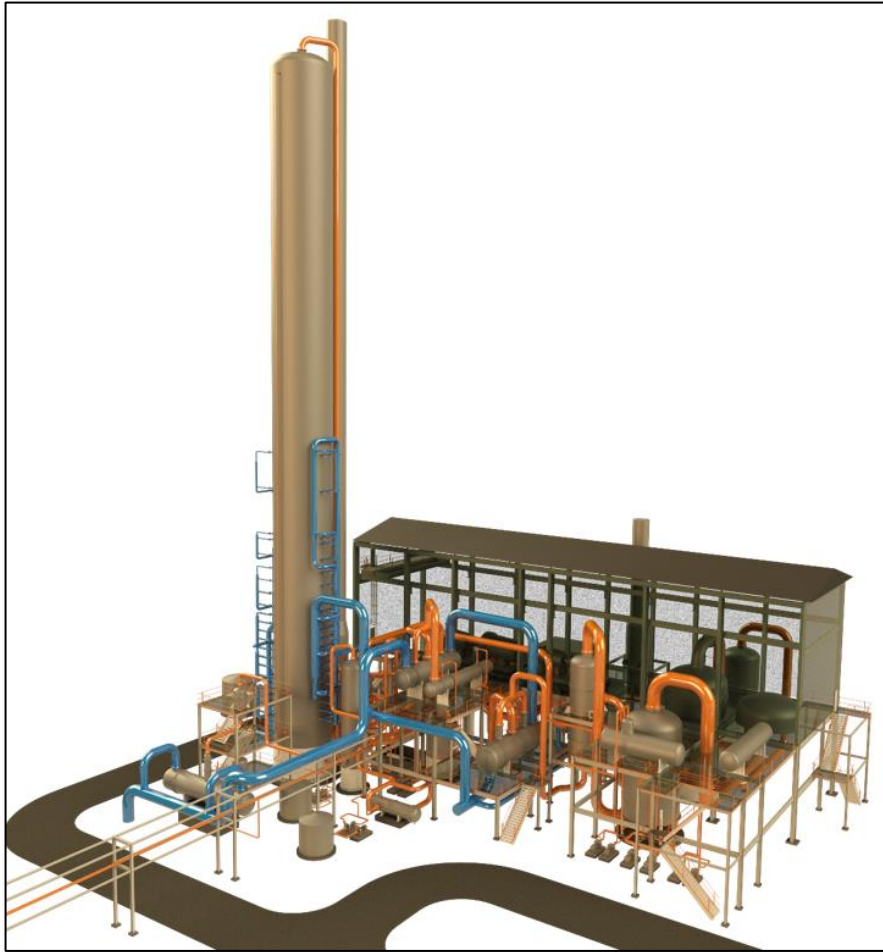

Figure 6: 3D model of a nitric acid plant

The gases from the outlet of the converter are first cooled by passing it through the cooler and after that the second chemical reaction step occurs in which nitrogen monoxide gets oxidized to oxides of nitrogen, primarily nitrogen dioxide and secondarily dinitrogen tetroxide. These are passed through a condenser in which some amount of nitric acid may be obtained. The major bulk of nitric acid is obtained in the absorption tower. The condensed nitric acid is directed to the absorption tower to get mixed with the bulk of the acid being produced.

The formed nitric acid in the cooler condenses together with the cold non-condensed nitrous containing vapors are sent to the absorption tower. The absorption tower gives residence time to the nitrogen monoxide in the vapor to form nitrogen dioxide that is absorbed to form nitric acid by adding process condensate from the ammonium nitrate section to the top of this tower.

## **Ammonia Nitrate Solution and Ammonial Nitrate Finishing Section**

The plant consists of non-simultaneous production of ~730tpd LDAN and ~980 tpd granulated CAN.

The Incro Multitubular Reactor (MTR) process will be used to produce an Ammonium nitrate solution (ANS) concentrated to over 95%. The (ANS) section will be common for both grades, whereas solids sections will differ, as Low density ammonium nitrate (LDAN) will be obtained in a prilling tower and Calcium ammonium nitrate (CAN) in a granulator, but they will share some common equipment, mainly in final product and scrubbing sections.

In LDAN case, the ammonium nitrate solution will be pumped to the ANS Prilling tower where prilling additive is added and heated-up with internal coils to avoid the crystallization of the solution. The LDAN prill is dried and cooled before storage.

In case of CAN, ANS is mixed with ground dolomite in a granulator before being dried, cooled and stored.

## **Utilities and off sites overview**

The production complex will require the following external supplies from over the fence:

- Raw Water
- Potable Water
- Renewable Power (EE)

Renewable Power availability has been assumed at steady conditions for all FC electrical duties and including the electrolyser unit.

Note, the Study does not consider the capital or operating costs for the infrastructure from over the fence.

Main utilities necessary for the overall complex:

- Demineralized Water Production
- Cooling Water Unit/s
- Liquid Nitrogen Storage
- Instrument and Plant Air Production
- Green Ammonium Nitrate Storage and Truckload
-

## **Demineralized Water Production**

Demineralized water is required in the fertilizer complex for three different purposes:

- As feed for Electrolyzers
- As feed for BFW / Steam generation in the Nitric Acid plant
- As feed to the CAN and LDAN plant

A typical Water Treatment plant has been considered as part of the FC. Possible integrations to produce Demi Water suitable for the selected Electrolyzer technology will be analyzed in future studies.

- Estimated Demi water Unit Capacity: 57 m<sup>3</sup>/h
- Estimated Raw Water consumption to produce Demi water : 117 m<sup>3</sup>/h

## **Cooling Water System**

Cooling Water Unit is foreseen to ensure cooling water to the new ammonia complex. This unit consists of:

- Cooling Water Tower
- Cooling Water Basin
- Cooling Water Supply Pumps
- Chemical Treatment Package

Estimated Cooling Tower Capacity: 8164 m<sup>3</sup>/h

Estimated Raw Water Make-up consumption: 294 m<sup>3</sup>/h

Raw Water Make-up consumption has been determined by assuming the following parameters (to be confirmed by Cooling Tower selected vendor) evaporation, drift losses and blowdown = 3.6 % of total cooling water

## **Total Raw Water Consumption**

The plant complex raw water consumption is estimated as:

- Raw water to produce DEMI water: 117 m<sup>3</sup>/h
- Raw water make up to CW system: 294 m<sup>3</sup>/h
- Plant water: 2.9 m<sup>3</sup>/h



- Total raw water intake to the FC: 413.9 m<sup>3</sup>/h

### **Instrument and Plant Air Consumption**

Instrument and Plant Air System is foreseen to ensure Plant Air and Instrument Air to the fertilizer complex.

Ambient Air is compressed to the pressure required by the Instrument and Plant air network.

Compressed Wet Air is sent to Plant Air Receiver, from which part is distributed as Plant Air and part is sent to the Air Dryers Package.

Part of the compressed and dried air is sent to Instrument Air Receiver before being distributed in instrument air network.

Instrument Air package design capacity is based on similar size projects. Estimated overall complex Instrument Air consumption: 1150 Nm<sup>3</sup>/h.

20% overdesign to include uncertainty and possible losses. Air Compressor for Instrument Air will be sized also for Plant Air production.

### **Ammonia Storage Tank**

To deal with downstream units shut down and to maintain the Ammonia plant in operation an Ammonia storage tank has been considered.

The sizing of such storage is based on the replacement of Pt/Rh gauzes in the Ammonia burner in the Nitric Acid plant, which is carried out every 9 months. This operation demands a 48 hour shut down of the Acid Nitric plant.

In order to avoid the whole fertilizer complex shutdown, an Ammonia daily storage tank with a capacity of 750 m<sup>3</sup> equivalent to 48 h of production, has been foreseen with the ammonia plant operating at 70% capacity plus the ammonia consumption at the ammonium nitrate plant at its maximum capacity.

The Ammonia Storage tank volume has been defined to:

- maintain the continuity of fertilizer production even during Nitric Acid shutdown for catalyst replacement; and
- cover almost the totality of unplanned shutdown in different units of the complex without interrupting fertilizer production.

The Nitric Acid plant has been designed with a NA storage tank with 48hs capacity, to allow a continuous operation in the LDAN/CAN plants during replacement of catalyst gauzes.

With the above-mentioned intermediate tanks, the NH<sub>3</sub> plant will be able to operate continuously during gauzes replacement in the NA plant, as well as during cleaning and maintenance shut down in the AN finishing plants.

### **CAN/LDAN Storage and Handling Facilities**

Storage and handling facilities have been added to enable bagging and truck loading.

- Fertilizer Handling to Storage
- Covered Storage
- Fertilizer Reclaiming to Silos
- Fertilizer Storage Silos, Truck Loading and Bagging Unit

Main parameters:

Fertilizer to be stored	CAN and LDAN
Daily fertilizer production	~980 MTPD and 730 MTPD
CAN Storage volume	equivalent to 15 days of production
LDAN Storage volume	equivalent to 15 days of production
Number of Piles	1 for CAN + 1 for LDAN
Max Pile Hight	15 meters
Bag size	25 kg
Volume for Truck Load Silos	equivalent to 8 hours of production
Volume for Bagging Silos	equivalent to 8 hours of production

## Green Ammonia Nitrate Complex Plot Plan

The green fertilizer complex including all process units as well as utilities and storage facilities requires and approximate area of 395 mts by 170mts (Figure 7). This is an initial plant lay out focused on optimizing space and reducing interconnection piping and cables racks to optimize the Capex. This does not include associated infrastructure from over the fence that will be required.

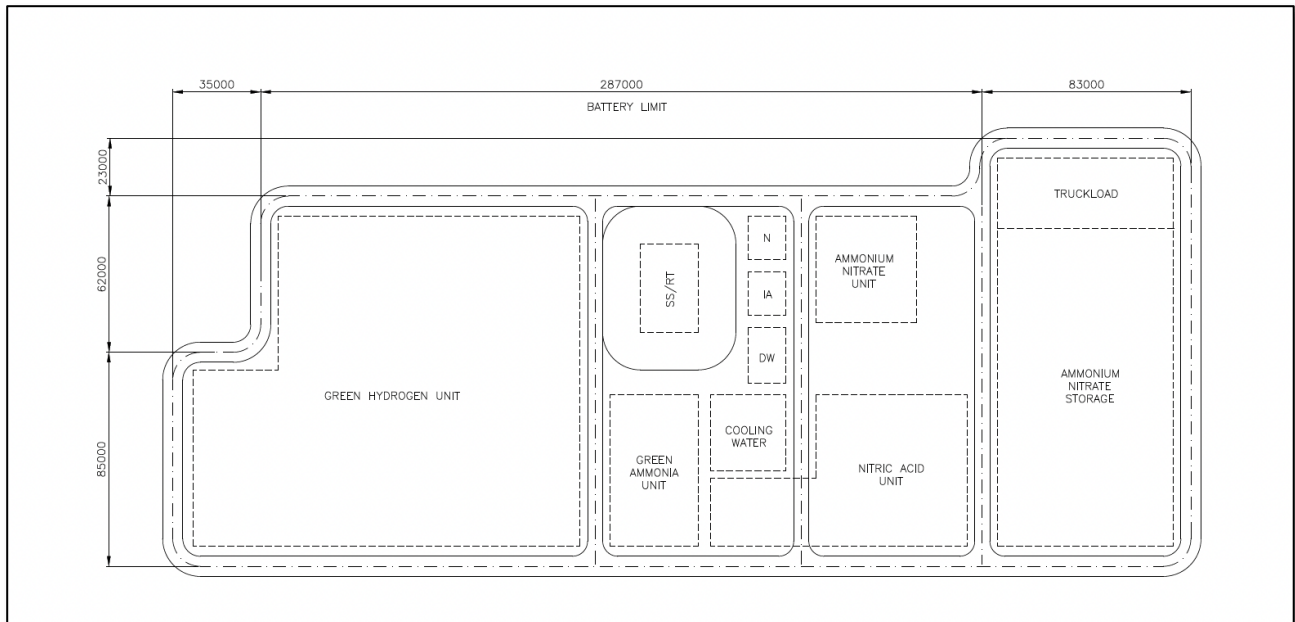

Figure 7 - Capanda Green Ammonia Plant, proposed layout .

## TECHNICAL STUDY: CAPITAL EXPENDITURE (CAPEX) ESTIMATE

The Cost Estimate has been carried out in accordance with Class 5 Cost Estimate, as per AACE R18-97 International (Association for the Advancement of Cost Engineering). recommended practice (Refer to Table 1).

For the level of information developed during the study and previous experience, the range of accuracy of the estimate is: +/-35%.

**Table 2: International recommended practice for the Association for the Advancement of Cost Engineering.**

<b>ESTIMATE CLASS</b>	<b>END USAGE</b> Typical purpose of estimate	<b>METHODOLOGY</b> Typical estimating method	<b>EXPECTED ACCURACY RANGE</b> Typical variation in low and high ranges [a]	<b>PREPARATION EFFORT</b> Typical degree of effort relative to least cost index of 1 [b]
<b>Class 5</b>	Concept Screening	Capacity Factored, Parametric Models, Judgment, or Analogy	L: -20% to -50% H: +30% to +100%	1
<b>Class 4</b>	Study or Feasibility	Equipment Factored or Parametric Models	L: -15% to -30% H: +20% to +50%	2 to 4
<b>Class 3</b>	Budget, Authorization, or Control	Semi-Detailed Unit Costs with Assembly Level Line Items	L: -10% to -20% H: +10% to +30%	3 to 10
<b>Class 2</b>	Control or Bid/Tender	Detailed Unit Cost with Forced Detailed Take-Off [c]	L: -5% to -15% H: +5% to +20%	4 to 20
<b>Class 1</b>	Check Estimate or Bid/Tender	Detailed Unit Cost with Detailed Take-Off	L: -3% to -10% H: +3% to +15%	5 to 100

## Notes:

a) The state of process technology and availability of applicable reference cost data affect the range markedly. The +/- value represents typical percentage variation of actual costs from the cost estimate after application of contingency (typically at a 50% level of confidence) for given scope.

b) If the range index value of "1" represents 0.005% of project costs, then an index value of 100 represents 0.5%. Estimate preparation effort is highly dependent upon the size of the project and the quality of estimating data and tools.

c) For those areas of the project still undefined, an assumed level of detail take-off (forced detail) may be developed to use as line items in the estimate instead of relying on factoring methods.

A class 5 Cost Estimate requires the following information:

- General process description of the plant;
- Capacities of any single Licensed and Open art process unit;
- Utilities description and relevant duty specification (capacity and process requirements); and
- Off-sites description and capacity.

Cost estimate execution methods are summarised in the following paragraphs

The cost structure includes equipment, bulk materials (including transport), construction, services, construction costs (including field supervision and commissioning activities and services include all engineering and procurement services necessary for the design of the plant (Table 2).

The Capex estimate is defined on the basis of preliminary information for each utility requirement given by the different process plant, with the basis capacity, Simplified description of the production scheme and product requirements.

**Table 2: Cost estimate summary by unit**

Description	€ (,000)
Electrolysers unit	143.187
Ammonia unit	71.000
Nitric acid	93,576
AN solution, Can and LDAN	60000
Nitrogen generation unit	10980
Demin water	2670
Cooling water	2712
Instrument air	5511
<b>Infrastructures</b>	
Substation and control room	16173
Storage building and handling	26900
<b>Total investment cost</b>	<b>432.709</b>

Note: The CAPEX estimation corresponds to a Class 5 of AACE Cost Estimate.

The cost estimate is based on capacity factors making reference to a Stamicarbon in-house database for similar units or, when these references are not available, on budgetary quotations received by specialized suppliers. Construction cost estimate is based on the same criteria described in previous paragraph, but different factors applied to cost of materials are considered, to take into account the different level of pre-assembly typical of these units.

The Capex estimate does not include two years spare parts, capital spare parts, Laboratory equipment, custom duties, staff training, financing costs, cash flow costs, insurances, taxes, infrastructures and non-EPC costs including land and working capital.

## **DEVELOPMENT AND FUNDING**

To achieve the complete the Capex involved to construct the Project based on the Study, funding in the order of EUR432 million will likely be required. Investors should note that there is no certainty that the Company will be able to raise funding when needed, however the Company has concluded it has a reasonable basis for providing the forward-looking statements included in this announcement and believes that it has a "reasonable basis" to expect it will be able to fund the development of the Project.

It is also possible that such funding may only be available on terms that may be dilutive to, or otherwise affect the value of the Company's existing shares. It is also possible that the Company could pursue other strategies to provide alternative funding options.

Minbos believes it has a reasonable basis to source the funding required for the Project for the following reasons:

- The Project has strong competitive advantage, including competitive and installed green electricity pricing, a genuinely zero-carbon project, high quality water and proximity to markets, which is now recognised as the gold standard for viable Green Hydrogen-Ammonia Projects.
- The Project has the potential to capture the ~\$200/t African Inland Premium for nitrogen products.
- Minbos has received significant inbound interest from major potential funding partners.
- The Project has unique characteristics which Minbos considers will likely be attractive to third party financiers.
- Minbos has entered into a Strategic Cooperation Agreement by a syndicate of investors includes Mr. Liang Feng, the Chairman of US \$18 Billion Shanghai Putailai New Energy. Under the terms of the Strategic Cooperation Agreement, the the syndicate of investors have agreed to assist the Company with various objectives, including securing potential debt financing sufficient to fund the capital expenditure requirements to construct the green ammonia production facilities in Angola.

Minbos is also in negotiations with a major explosives manufacturer with existing distribution in the Western Copper Belt with a view to establishing a joint venture. The negotiations are premised on the incoming party arranging project finance and carrying Minbos for a significant proportion of its equity contribution. Minbos expects that it will be able to conclude this type of arrangement with this potential partner or, failing that, with a partner of a similar scale and size that is capable of arranging project finance for the Project.

Stamicarbon has advised Minbos that the following schedule is typical for green ammonia projects of this scale. Minbos is progressing project activities including initial discussions with RNT regarding load supply matching and the purchase of land for the construction of the plant.

FEL 2	8 months	
FEED phase		12 months
Construction		Construction phase 32 months
Total schedule	48 months	

The schedule considers the option to order the LLI during FEED phase, to shorten the Construction phase in this example 4 months.

## ABOUT GREEN AMMONIA

A traditional ammonia plant converts fossil fuel and steam into so-called syngas, a gas consisting of hydrogen and carbon monoxide, through a method known as ‘steam reforming’. The hydrogen is one of the two components from which ammonia is produced (Figure 8).

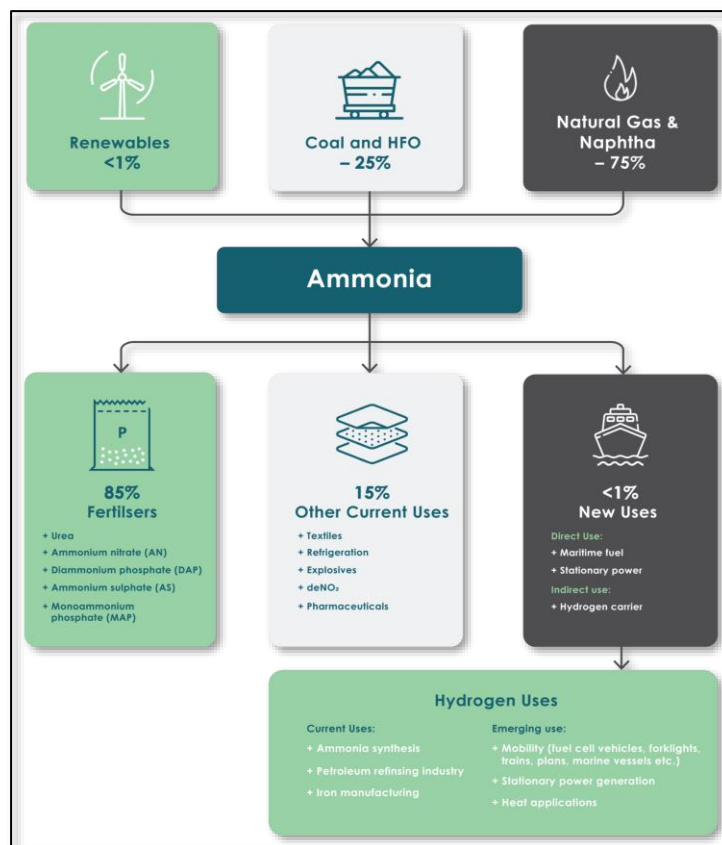

Figure 8 - Green, Grey and Blue Ammonia energy and production inputs and end uses.

The other component is nitrogen, which is the dominant component in air that is taken into the plant (with or without pre-treatment). Ammonia is synthesized from hydrogen and nitrogen. The

carbon monoxide is converted to carbon dioxide and is often, if not used for urea production, (largely) emitted into the atmosphere, as a greenhouse gas, contributing to global warming.

The presence of carbon as a result of using fossil fuels makes the ammonia produced this way often referred to as “grey” ammonia.

By eliminating the use of fossil fuels, an environmentally friendly process is created in which hydrogen is made via water electrolysis instead of the steam reforming of fossil fuels. The energy needed comes from renewable, sustainable resources, such as wind or solar energy. The output is carbon-free ammonia, also known as Green Ammonia, the primary feedstock for green fertilizers (Figure 9).

Green Ammonia can also be used as a renewable energy carrier (e.g., in shipping fuel) or as a renewable feedstock for other processes. The Stamicarbon Green Ammonia technology offers a total solution for carbon-free and sustainable ammonia production.

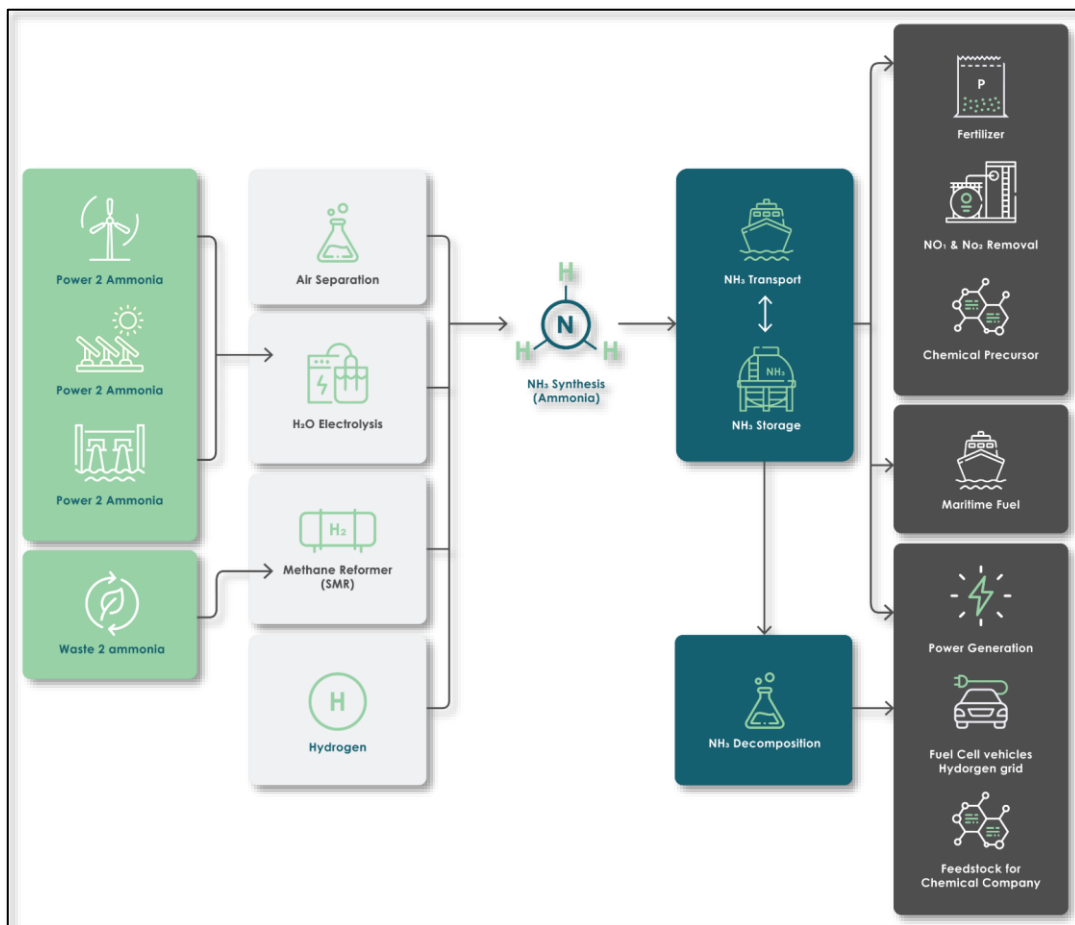

Figure 9 - Green Ammonia production flowsheet and end uses.

**-END-**

This announcement is authorised for release by the Board of Minbos Resources Limited.



For further information please contact:

**Investor and Media Enquires**

E: [info@minbos.com](mailto:info@minbos.com)

P: +61 8 6219 7171

**Compliance Statement**

The Company confirms that it is not aware of any new information or data that materially affects the information included in the original market announcement and, in the case of material assumptions and technical parameters underpinning the estimates in the relevant market announcement continue to apply and have not materially changed.

**Forward Looking Statements**

Statements contained in this release, particularly those regarding possible or assumed future performance, revenue, costs, dividends, production levels or rates, prices, or potential growth of Minbos Resources Limited, are, or may be, forward looking statements. Such statements relate to future events and expectations and, as such, involve known and unknown risks and uncertainties. Actual results and developments may differ materially from those expressed or implied by these forward-looking statements depending on a variety of factors.