

**Primed to commence
ferromanganese
alloy production
H2 2019.**

Corporate Presentation

February 2019

Investor Information



This presentation has been prepared by Gulf Manganese Corporation Limited ("Gulf") for the exclusive use of the party to whom Gulf delivers it to. The presentation should not be regarded as a substitute for the exercise of their own judgement.

The valuations, forecasts, estimates, opinions and projections contained herein involve subjective judgment and analysis. Any opinions expressed in the material may be subject to change. The presentation contains forward looking statements and any estimates or projections are based upon the best judgement of Gulf and on currently available information. All currency referred to in this presentation is based on USD.

The presentation has been prepared solely for informational purposes and should not be construed as an offer to buy or sell securities. The Recipient should not construe the contents of the matters presented as providing legal, tax, accounting or investment advice or recommendation. The Recipient should consult their own counsel, tax and financial advisors as to any matters related to the presentation. The presentation does not purport to be all inclusive or to contain all of the information that the Recipient may require to evaluate Gulf. No investment, divestment or other financial decisions or actions should be based solely on the information in this presentation.

The presentation has been prepared on a confidential basis for the use and benefit of the Recipient. Distribution to any other person other than the Recipient is not authorised and material should not be copied, reproduced, distributed or passed to others without the prior consent of Gulf.

Thank you.



Value Proposition

Gulf

On track for construction to be completed in H2 2019

Construction over 60% complete with first commercial alloy sales expected during Q3 2019

Clear pathway to production ramp-up

Low-cost, highly scalable production starting at 43,000 tpa, increasing to 201,000 tpa of ferromanganese alloy.

Mine-gate to production acquisition strategy

Actively assessing acquisition opportunities targeting high grade Mn mines in Indonesia – home to the world's highest grade manganese (+49%Mn).

Multiple revenue streams

Export of refined ferromanganese alloys of Medium and Low Carbon manganese alloys, and export of Direct Shipping Ore (DSO).

Strong in-country partnerships

Gulf backed by PT JTS, whose Chairman and CEO is Bapak Fofa Sariatmadja, a highly-regarded Indonesian business executive.



Kupang Smelting Hub Financials



Kupang Smelter Project		Annualised Performance			
		2 Units	4 Units	6 Units	8 Units
Installed Smelter Capacity	MVA	14	32	50	68
Physicals					
Mn Ore Purchased	†	112,000	247,000	385,000	524,000
FeMn Alloy Sold	†	43,000	95,000	148,000	201,000
Costs					
Ore Purchase & Preparation	USD	19.3	42.6	66.4	90.2
Smelting	USD	33.3	73.6	114.6	155.7
Overheads	USD	5.5	12.2	18.9	25.7
Total Operating Costs	USD	57.7	127.5	198.6	269.7
Revenue from Sales	USD	81.7	180.5	281.2	381.9
Operating Margin	USD	24.0	53.0	82.6	112.2

Notes:

1. Does not include revenue from Direct Shipped Ore “DSO” Sales
2. Based on 100% of project. GMC will have 74.9% with JTS 25.1% ownership of project.
3. Before Tax and Interest
4. All financials in millions
5. Assumes all ore purchased from local Indonesian miners in NTT and adjacent provinces
6. Refer to slide 19 for assumptions on annualised performance figures

Kupang, West Timor Excellent Infrastructure

Gulf



Tenau Port – Kupang

Gulf

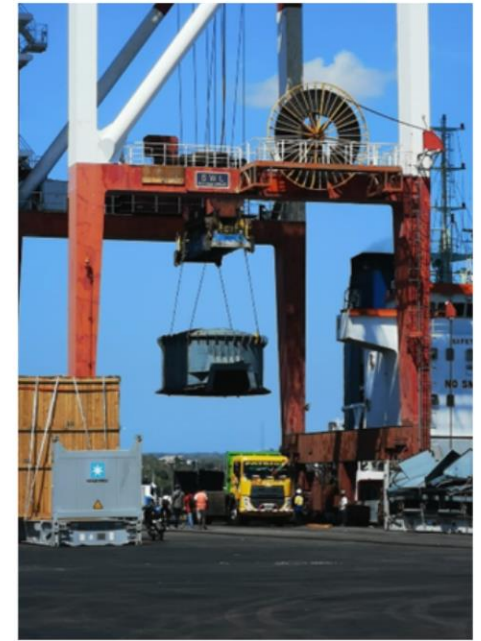

Unloading of Smelters at
Tenau Port, Kupang

Deepwater Port Facility
5km from Smelter Hub Site

Building a successful Indonesian Smelting business

Gulf

Significantly de-risked exposure to Indonesia's world-class high grade Mn deposits.

Key Milestone / Achievement		Completed / Due Date
1.	Licencing, Permitting Approval	✓
2.	Secure Cornerstone Indonesian Investors	✓
3.	Securing Indonesian High Grade Mn Mine	In Progress
4.	Commissioning Complete	H2 2019
5.	First Ferromanganese Alloy Sales	Q3 2019
6.	Direct Shipped Ore Licence "DSO"	Expected Q1 2019



PT JTS - Significant Local Partners

Gulf

- JTS Group: part of a diversified investment group based in Indonesia and Australia, with investments across the Asia Pacific region.
- JTS Group holds 9.04% of GMC and 25.1 % of the Indonesian Subsidiary PT GMG* with the completion of conditions precedent on convertible notes.
- Chairman and CEO Bapak Fofa Sariaatmadja is President Commissioner with:
 - ❑ PT. Surya Citra Televisi, the number one television in Indonesia
 - ❑ PT. Mediatama Anugrah Citra, the only digital terrestrial pay-TV operator in Indonesia
 - ❑ PT. Abhimata Persada, an IT solutions provider to the banking sector.

(*following MoEMR approval)

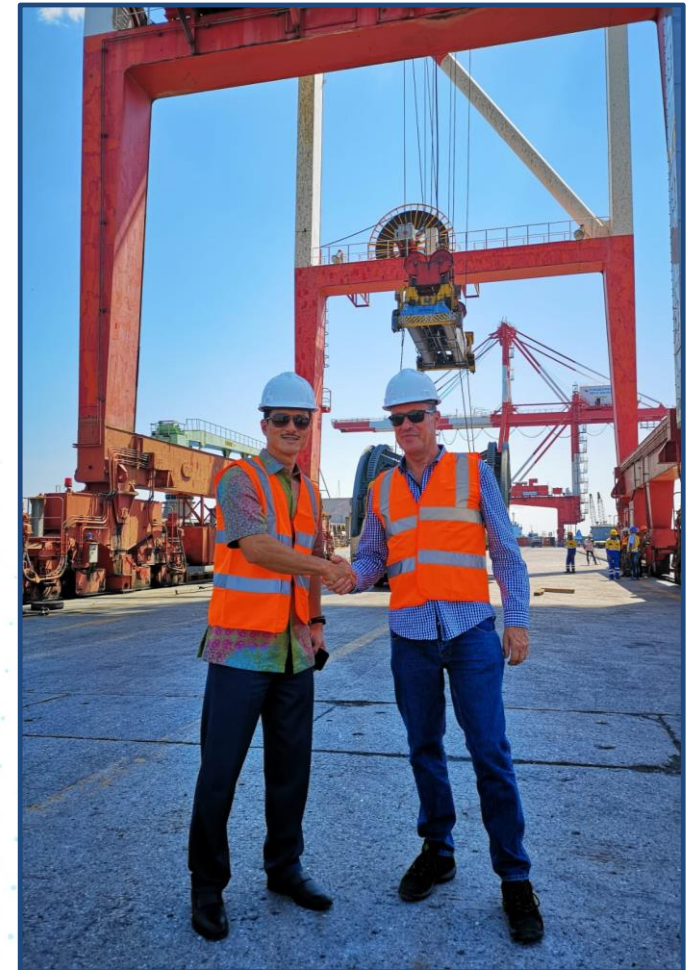

Gulf President Director Hamish Bohannan with PT JTS Chairman and CEO Bapak Fofa Sariaatmadja

Manganese Ore Resources West Timor

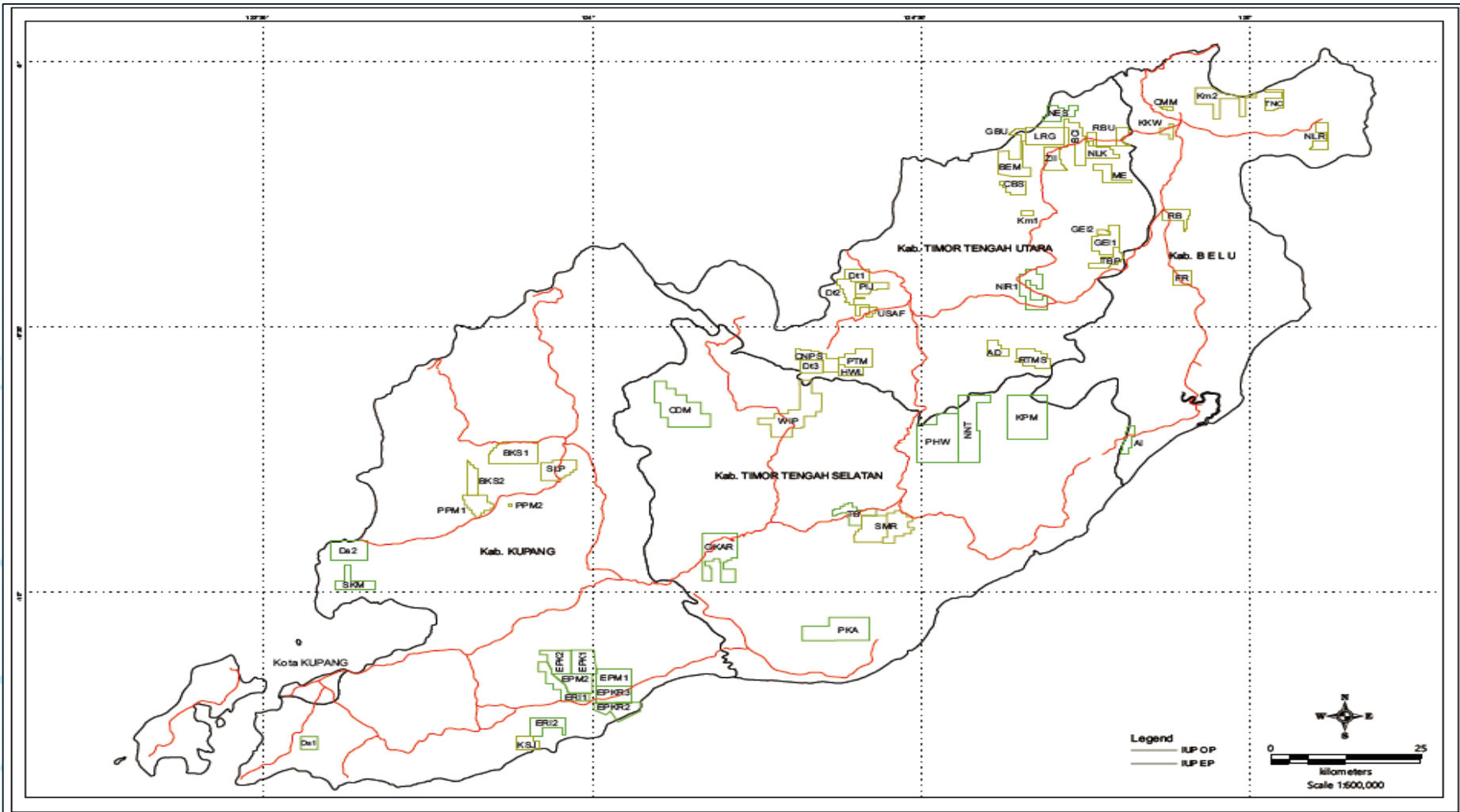

Map showing Clean and Clear IUPs (Mn) in West Timor

Manganese Ore - Procurement Strategy



- NTT focussed procurement strategy with 20 agreements in place with NTT miners
- Gulf is committed to working with NTT miners to ensure best mining practice and exemplar in establishing NTT as a manganese world class leader
- Gulf committed to purchase manganese ore only from suppliers who demonstrate they have all required permits, licences, certificates and approvals as required by Government regulations (clean and clear).
- Negotiations well advanced with miners in other locations within Indonesia and Timor Leste
- Discussions with international manganese ore suppliers



Kupang Smelting Hub Facility

Gulf

- Construction activities on the first two smelters, are progressing.
- Targeting production of premium quality 82%+ manganese alloy resulting from the unique qualities of the Indonesian high-grade, low impurity manganese ore.
- Targeting sale of Direct Shipped Ore (DSO) during construction phase - significant near-term value catalyst.
- Option to build Gulf's own shipping berth to further reduce logistics costs.
- Power supplied by state power utility on unit cost basis from power station directly adjacent to smelter site.
- Nearby deep water Tenau Port has both bulk and container loading facilities.



Concrete Foundations Finished at Smelting Hub Facility



Nearby Tenau Port – has both bulk and container loading facilities

Smelter – Unique Process & Expandable

Modular design allows for simple expansion

- At least 8 furnaces to be in operation upon completion

Processing

- Silicothermic reaction
- Process driven by the unique ultra high grade ore
- Low power consumption
- Produces very high grade Low Carbon Ferro Manganese alloy in a single stage

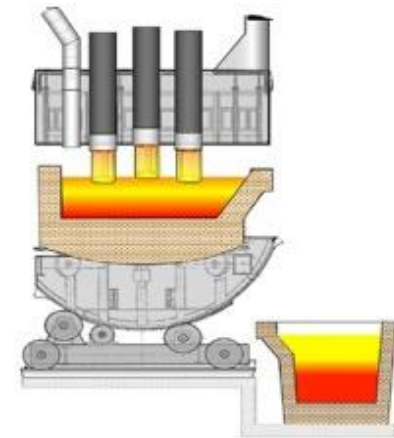

Manganese Market



- Over 90% of all manganese produced is consumed in steel production
- Refined ferromanganese alloys are usually used in the manufacture of high grade specialty steel
- Gulf's DSO and refined alloy products will be in very high demand due to their high manganese content and low impurities.
- Manganese ore prices remain strong driven by Chinese steel industry combined with deterioration of manganese ore grades globally and within China.
- After steel, the second most important market for manganese (in dioxide form) is for portable dry cell batteries.
- Other uses include manganese sulphates as an agricultural fertilizer, in water purification, health vitamins, gasoline additives and colouring glass.



Indonesia - World's Highest Grade Mn deposits

Gulf

- High Grade (>48%)
- High grade (+44%)
- Medium to low grade (<44%)

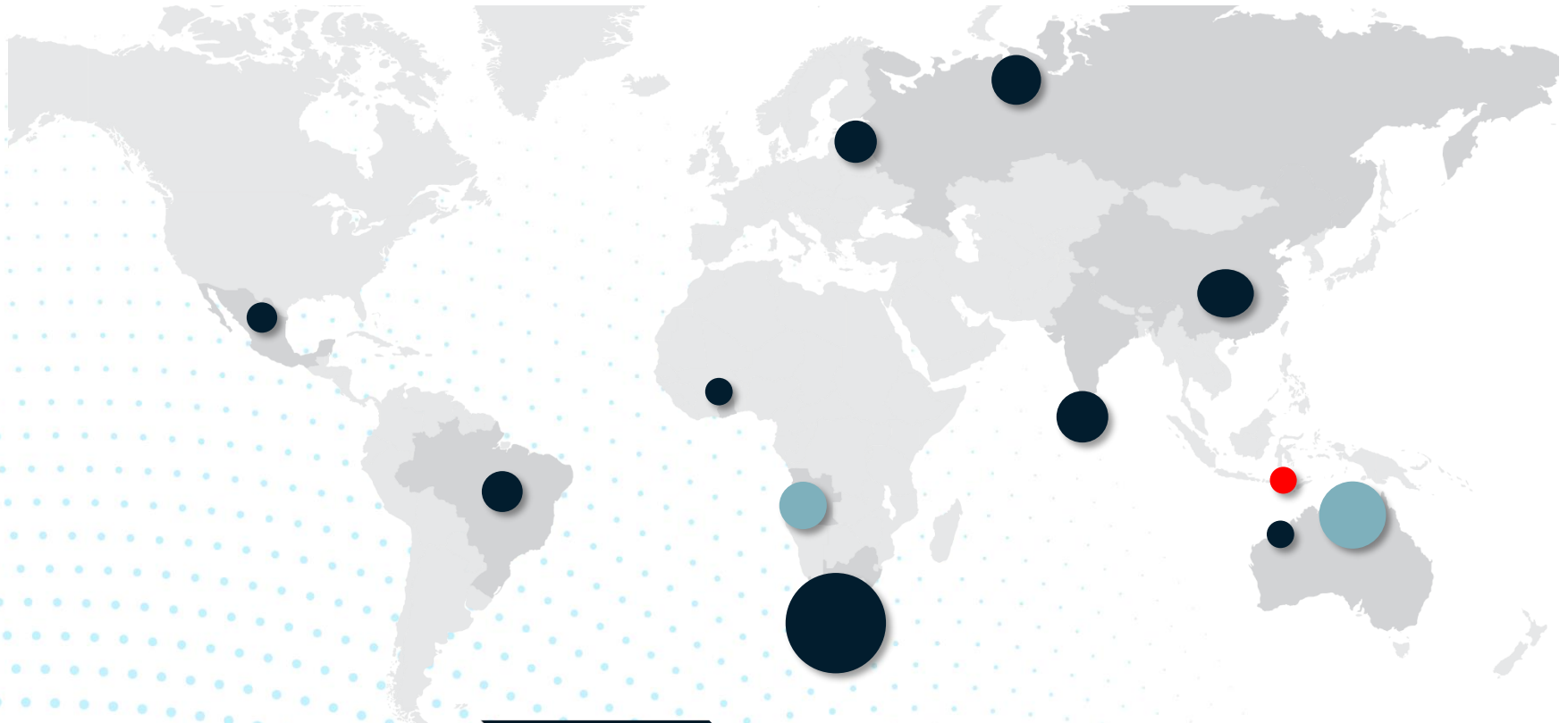

Manganese Value Chain – Geared for Growth

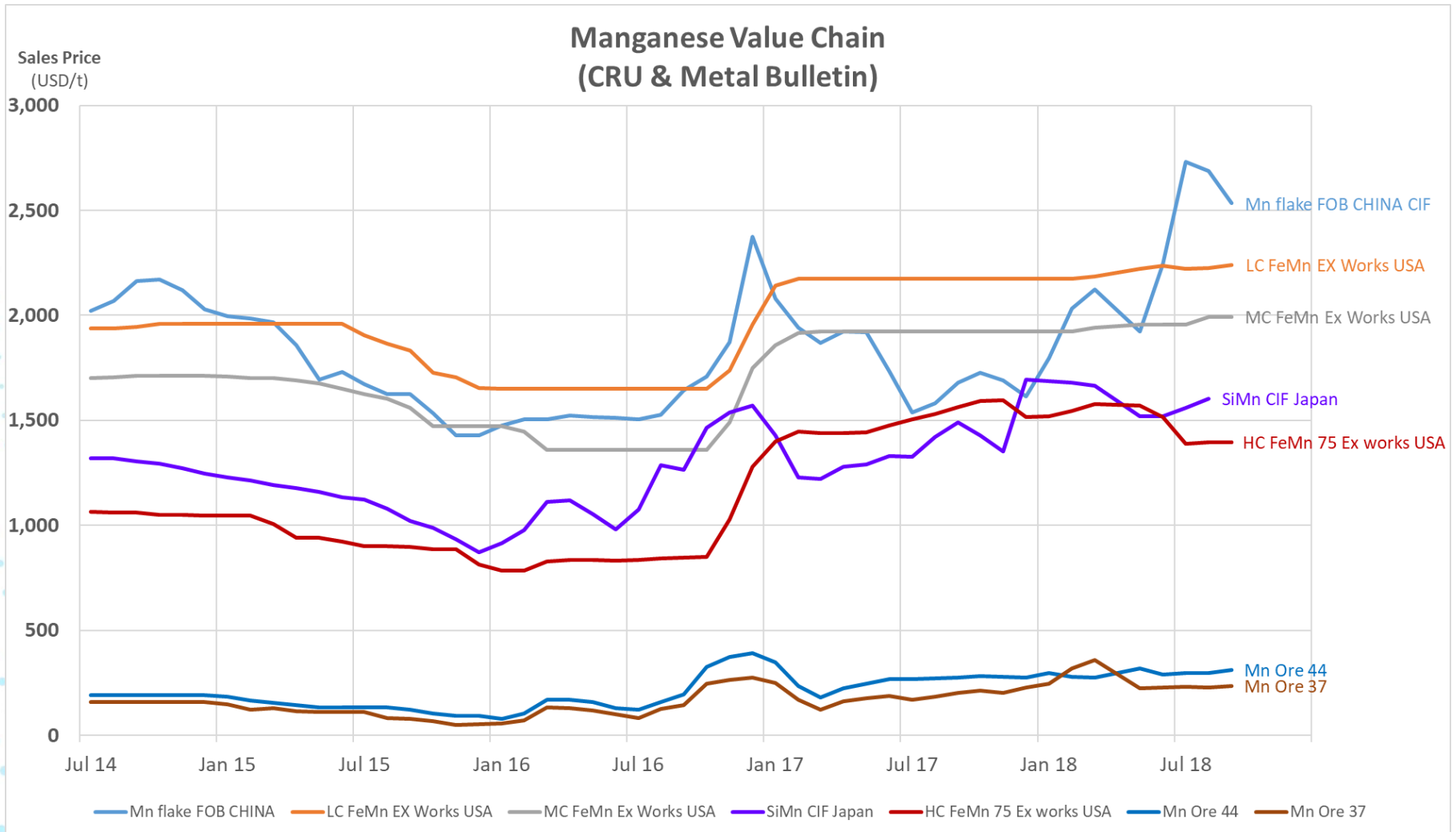

Corporate Snapshot

Capital Structure	
ASX Code:	GMC
Shares on Issue	3,510,746,449
Listed Options on Issue (0.5c Exp 21/4/19)	1,850,621,403
Share Price / 30 day VWAP (as at 24 Jan 2019)	1.05¢
52 week high / low	2.5¢ / 0.5¢
Market Cap (24 Jan 2019)	\$A 28 million

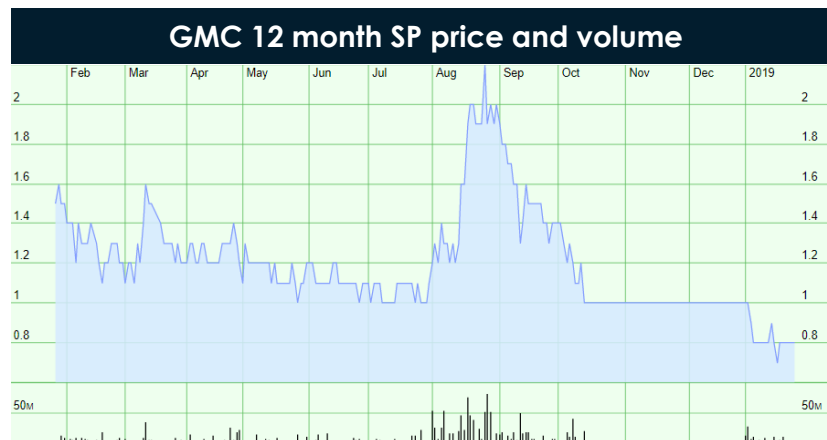

Top Shareholders	
Citicorp Nominees Pty Ltd	13.31%
HSBC (Tanah Capital PE)	10.41%
JTS Group (EBI, JGI, JTS)	9.04%

Board and Management	
Non-Executive Chairman	Craig Munro
Managing Director & CEO	Hamish Bohannan
Non-Executive Director	Andrew Wilson
Non-Executive Director	Tan Hwa Poh
Company Secretary & CFO	Robert Ierace



Kupang Smelting Hub - Assumptions



Kupang Smelter Project				LCFeMn Alloy _(LP)				
Smelters			each	2	4	6	8	
Installed Capacity	2,260	t/MVA	MVA	14.0	32.0	50.0	68.0	
Physicals								
Mn Ore Purchased			tpa	112,000	247,000	385,000	524,000	
FeMn Alloy Sold			tpa	43,000	95,000	148,000	201,000	
				USDm	USDm	USDm	USDm	USD/t
Ore Purchase & Preperation	\$172.01	/t purch		19.3	42.6	66.4	90.2	448.84 33.2%
FeSi75%	0.341	t/t FeMn		17.6	38.9	60.6	82.3	409.30 30.3%
Burnt Lime	0.713	t/t FeMn		2.1	4.6	7.2	9.8	48.84 3.6%
Electrode Paste	0.023	t/t FeMn		0.6	1.3	2.1	2.8	13.95 1.0%
Power	\$0.089	/kWh		7.0	15.5	24.1	32.7	162.79 12.0%
Salaries/Wages				1.7	3.8	5.9	7.9	39.53 2.9%
Laboratory				0.4	0.9	1.4	1.9	9.30 0.7%
Smelter Consumables				2.0	4.4	6.9	9.3	46.51 3.4%
Logistics				0.7	1.5	2.4	3.3	16.28 1.2%
Maintenance				1.0	2.2	3.4	4.7	23.26 1.7%
Fuels/Oils				0.1	0.2	0.3	0.5	2.33 0.2%
Environmental				0.1	0.2	0.3	0.5	2.33 0.2%
Smelting				52.2	115.3	179.7	244.0	774.42 57.3%
General & Administration				2.1	4.6	7.2	9.8	48.84 3.6%
Sales & Marketing				3.0	6.6	10.3	14.0	69.77 5.2%
Overheads				0.4	0.9	1.4	1.9	9.30 0.7%
Overheads				5.5	12.2	18.9	25.7	127.91 9.5%
Total Op Costs				57.7	127.5	198.6	269.7	1,351.16
Revenue	\$1,900	U\$/t		81.7	180.5	281.2	381.9	1,900.00
Net Operating Margin				24.0	53.0	82.6	112.2	548.84



Pre-Construction

Showing Bolok Industrial Estate Land,
Backing on to Government Owned Power Station







Smelters Shipped

Shipped from the Port of Durban to Tenau Port Kupang
May 2018

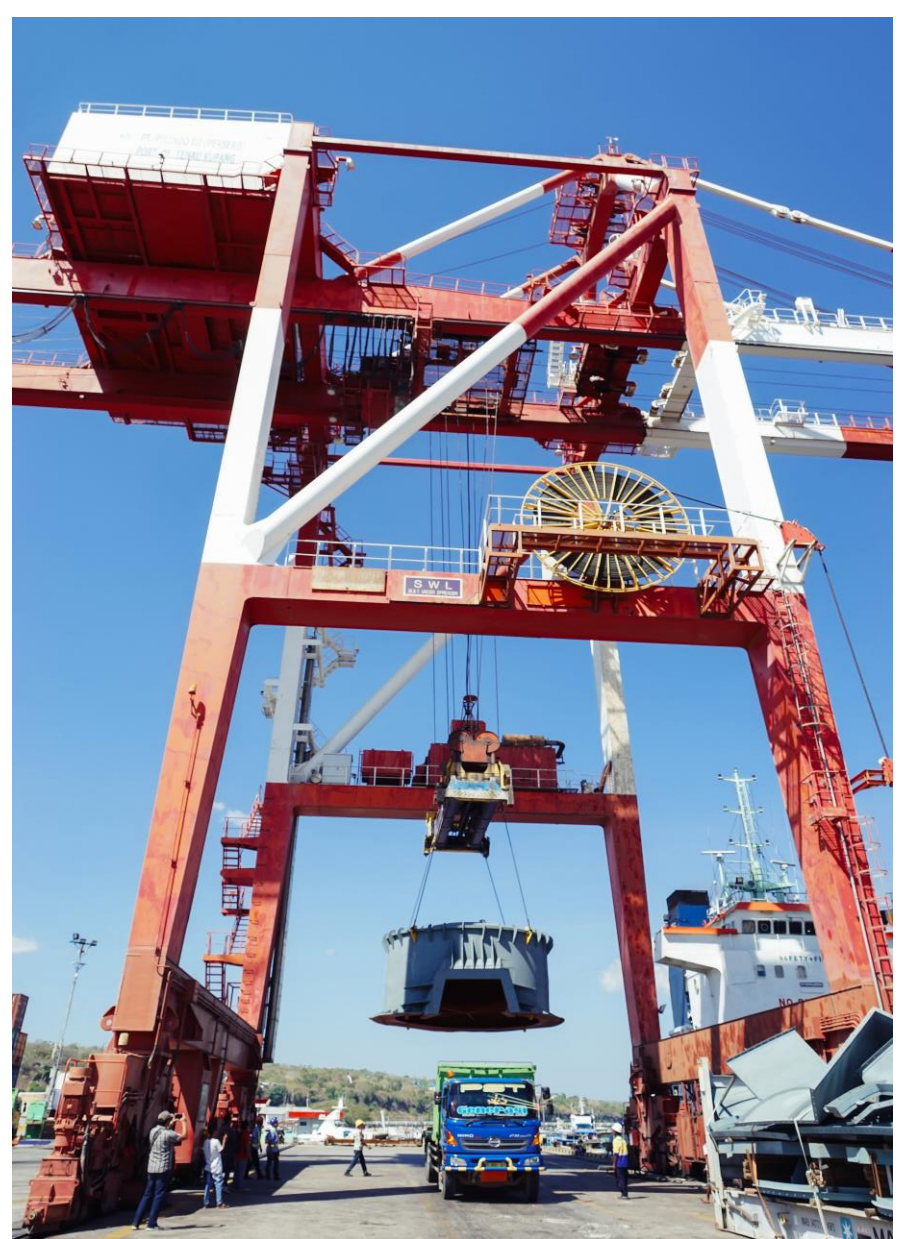

Gulf

Smelters Arrive in Kupang

July 2018







Gulf



Smelters on Site and Construction Progressing

- Structural steel fabrication is now complete.
- Construction over 60% complete



Gulf Manganese Corporation Ltd

T4, 152 Great Eastern Highway

Ascot WA 6104

Ph: +61 8 9367 9228

Fax: +61 8 9367 9229

E: info@gulfmanganese.com