

Melbourne, 22 August 2016

## **Syerston Nickel/Cobalt Mineral Resource Estimate**

### **Updated Resource Estimate demonstrates potential for Syerston to become a leading global supplier of cathode raw materials to the lithium-ion battery industry**

#### **Highlights**

- **Update to global nickel/cobalt Mineral Resource Estimate confirms approximately 700 kt of contained nickel and over 110 kt of contained cobalt, making Syerston one of Australia's largest undeveloped nickel/cobalt resources**
- **Over 92% of the Updated Mineral Resource Estimate is in the Measured and Indicated categories**
- **Cobalt grades position Syerston to be one of the largest global suppliers of cobalt outside Africa**
- **Potential to fast track development with key work programmes, infrastructure and permits already in place - prior feasibility study completed; Project located adjacent to existing road and rail line; water allocation secured; EIS approved; and Development Consent for a 2.5 Mtpa operation granted**
- **Nickel/Cobalt Project Prefeasibility Study (PFS) to be released shortly**
- **The PFS will assess potential for a 1.5 - 2.5 Mtpa mining operation to produce high purity nickel sulphate and cobalt sulphate products to supply the global lithium-ion battery industry**
- **The Project has the potential to generate significant scandium by-product credits, opening options for a step change reduction in scandium oxide production costs**

Clean TeQ Holdings Limited (ASX: CLQ) is pleased to announce an update to the Syerston Nickel/Cobalt Mineral Resource. The Updated Resource Estimate is summarised in Table 1 below.

**Table 1: Syerston Summary Nickel/Cobalt Mineral Resource Estimate, 0.60%NiEQ Cut-off<sup>1</sup>**

Classification Category	Tonnage (Mt)	Ni Grade %	Co Grade %	Ni Metal Tonnes	Co Metal Tonnes
Measured	52	0.73	0.11	380,000	57,000
Indicated	49	0.58	0.10	280,000	49,000
<b>Meas + Ind</b>	<b>101</b>	<b>0.65</b>	<b>0.10</b>	<b>660,000</b>	<b>106,000</b>
Inferred	8	0.54	0.10	50,000	8,000
<b>Total</b>	<b>109</b>	<b>0.65</b>	<b>0.10</b>	<b>700,000</b>	<b>114,000</b>

Notes: Any apparent arithmetic discrepancies are due to rounding  
NiEQ = nickel equivalent

The Mineral Resource Estimate, that has been undertaken by McDonald Speijers and conforms to JORC 2012 standards, updates a resource estimate made by them in 2005 for Ivanplats Syerston Pty Ltd (**Ivanplats**) and incorporates additional drilling results obtained since that time. The 2005 resource estimate followed programmes of infill drilling conducted by Ivanplats, subsequent to a resource estimate published by Black Range Minerals Limited (**BRM**) in 1999.

Of particular note are the grades of cobalt reported in the Updated Mineral Resource Estimate. The ratio of cobalt to nickel grades is unusually high when compared to other global nickel laterite resources<sup>2</sup> (see Figure 1).

Between 1999 and 2000, BRM undertook a Feasibility Study<sup>3</sup> on the Syerston Project to evaluate the economic potential of a mine processing 2.0 Mtpa of ore over a 36-year mine life, with an average plant feed grade of 0.99% nickel and 0.24% cobalt in the first three years of operation, and 0.88% nickel and 0.17% cobalt over the first 20 years of operation. The planned capacity of the Project was 20,000 tpa of contained nickel and 5,000 tpa of contained cobalt. This indicates the potential of the Syerston Project to become a significant global producer of cobalt owing to the significant cobalt grades of the laterite.

In addition to nickel and cobalt, a range of accessory elements were included in the estimation process. For the purposes of the nickel/cobalt resource estimate, none of these were treated as potential economic by-products and none were taken into account in calculating nickel equivalent (**NiEQ**) values for cut-off grade application. Consequently, they were not subjected to the same level of technical scrutiny as nickel and cobalt, particularly in relation to sampling and assaying quality controls.

<sup>1</sup> NiEQ cutoff was calculated as  $NiEQ\% = Ni\% + (Co\% \times 2.95)$ , based on assumed metal prices of US\$4.00/lb Ni, US\$12/lb Co, at USD:AUD exchange rate of 0.70. NiEQ was calculated on Ni and Co only, with no consideration for scandium or platinum.

<sup>2</sup> Comparison of global nickel laterite projects as per SNL Metals and Mining database [www.snl.com/Sectors/metalsmining/Default.aspx](http://www.snl.com/Sectors/metalsmining/Default.aspx)

<sup>3</sup> Results quoted from Black Range Minerals Annual Report 2000 (ASX: BLR)

**Figure 1: Undeveloped Cobalt-Containing Nickel Projects (excludes African and seabed mining projects)**

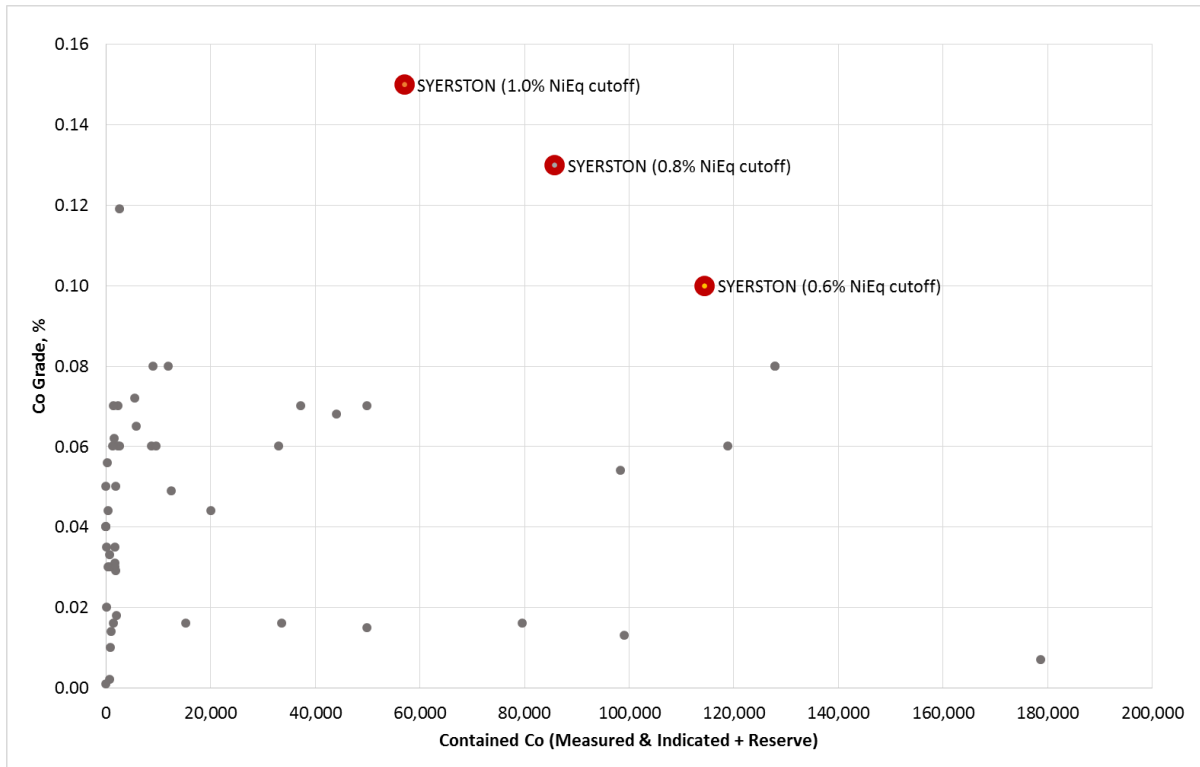

Source: SNL global database. Comparator group comprises undeveloped nickel projects with declared cobalt resources, excluding African and seabed mining projects. Figures represent latest reported resources (inclusive of reserves) of cobalt. Syerston figures based on Updated Resource Estimate to JORC 2012.

The following table (Table 2) provides a summary of the current resource estimate at a range of different nickel equivalent cut-off grades, including selected accessory elements.

**Table 2: Updated Mineral Resource Estimate at a range of NiEQ cut-off<sup>1</sup> grades**

Cut-off NiEQ %	Classification Category	Tonnage (Mt)	Grades								
			Ni %	Co %	Accessory Elements						
					Pt g/t	Sc* ppm	Fe %	Al %	Ca %	Mg %	Mn %
0.6	Measured	52	0.73	0.11	0.20	51	35	2.5	0.38	1.3	0.80
0.6	Indicated	49	0.58	0.10	0.21	56	35	2.3	0.40	1.2	0.70
<b>0.6</b>	<b>Meas + Ind</b>	<b>101</b>	<b>0.65</b>	<b>0.10</b>	<b>0.21</b>	<b>54</b>	<b>35</b>	<b>2.4</b>	<b>0.39</b>	<b>1.2</b>	<b>0.75</b>
0.6	Inferred	8	0.54	0.10	0.16	78	36	2.8	0.38	1.4	0.78
<b>0.6</b>	<b>Total</b>	<b>109</b>	<b>0.65</b>	<b>0.10</b>	<b>0.20</b>	<b>56</b>	<b>35</b>	<b>2.4</b>	<b>0.39</b>	<b>1.2</b>	<b>0.75</b>
0.8	Measured	37	0.81	0.13	0.21	53	37	2.5	0.28	1.1	0.93
0.8	Indicated	26	0.66	0.13	0.23	53	37	2.3	0.30	1.0	0.87
<b>0.8</b>	<b>Meas + Ind</b>	<b>64</b>	<b>0.75</b>	<b>0.13</b>	<b>0.22</b>	<b>53</b>	<b>37</b>	<b>2.4</b>	<b>0.29</b>	<b>1.1</b>	<b>0.90</b>
0.8	Inferred	4	0.66	0.12	0.18	65	39	2.5	0.22	1.0	0.93
<b>0.8</b>	<b>Total</b>	<b>67</b>	<b>0.74</b>	<b>0.13</b>	<b>0.22</b>	<b>53</b>	<b>37</b>	<b>2.4</b>	<b>0.29</b>	<b>1.1</b>	<b>0.90</b>
1.0	Measured	25	0.90	0.15	0.22	54	39	2.5	0.22	1.0	1.07
1.0	Indicated	12	0.74	0.16	0.26	50	39	2.4	0.24	0.9	1.08
<b>1.0</b>	<b>Meas + Ind</b>	<b>36</b>	<b>0.85</b>	<b>0.16</b>	<b>0.24</b>	<b>53</b>	<b>39</b>	<b>2.5</b>	<b>0.23</b>	<b>1.0</b>	<b>1.07</b>
1.0	Inferred	2	0.75	0.14	0.20	57	42	2.4	0.13	0.8	1.04
<b>1.0</b>	<b>Total</b>	<b>38</b>	<b>0.84</b>	<b>0.15</b>	<b>0.23</b>	<b>53</b>	<b>39</b>	<b>2.5</b>	<b>0.23</b>	<b>1.0</b>	<b>1.07</b>

Notes: Any apparent arithmetic discrepancies are due to rounding

NiEQ = nickel equivalent, g/t = grams per tonne, ppm = parts per million Mt = million tonnes

\*Sc grades estimated independently by OreWin Pty Ltd

### Note Relating to Scandium

Prior to 2014, scandium was regarded as one of several minor accessory elements present in the laterite profile at Syerston. Since acquiring the Project, Clean TeQ has pursued its interest in the potential for development of the scandium mineralisation. The nickel and cobalt resource area contains a noteworthy endowment of background-grade scandium, as well as a minor contribution from localized zones of high-grade scandium that occur mostly, but not exclusively, around the periphery of the nickel/cobalt resource area. While the average scandium grade over the deposit is low, the potential to generate significant by-product revenues from scandium oxide production, for a relatively minor incremental cost, could add substantial by-product credits to a nickel/cobalt development.

In early 2016, Clean TeQ commissioned OreWin Pty Ltd to develop an independent resource estimate for high-grade scandium, with the aim of assessing whether the high-grade scandium may be considered as a standalone project. The results of this work were announced to the ASX on 17<sup>th</sup> March 2016. In mid-2016, Clean TeQ commissioned OreWin Pty Ltd to update the background scandium model throughout the nickel/cobalt resource area. The estimated scandium reported in the nickel/cobalt resource that is the subject of this current announcement is largely comprised of low-grade background scandium that is considered to be accessory to the nickel/cobalt resource and not standalone scandium resource in its own right. Only a small proportion (less than 10%) of the

previously announced scandium Mineral Resource (17<sup>th</sup> March 2016) is contained within the current nickel/cobalt Mineral Resource at the quoted NiEq cut-off. The scandium Mineral Resource from 17<sup>th</sup> March 2016 remains unchanged.

The Syerston Project is located 4 km from the regional town of Fifield (350 km north-west of Sydney). The Fifield District is noted for its intense magnetic anomalism and significant occurrences of minerals containing nickel, cobalt, scandium and platinum. The project lies within EL 4573 and several MLA's overlay the same project area (shown in Figure 2 below). The Project also contains a limestone deposit to the south-east, as well as an established bore field with water rights to the south. The EL and the MLA's are 100% owned by Clean TeQ.

**Figure 2: Syerston Project Area**

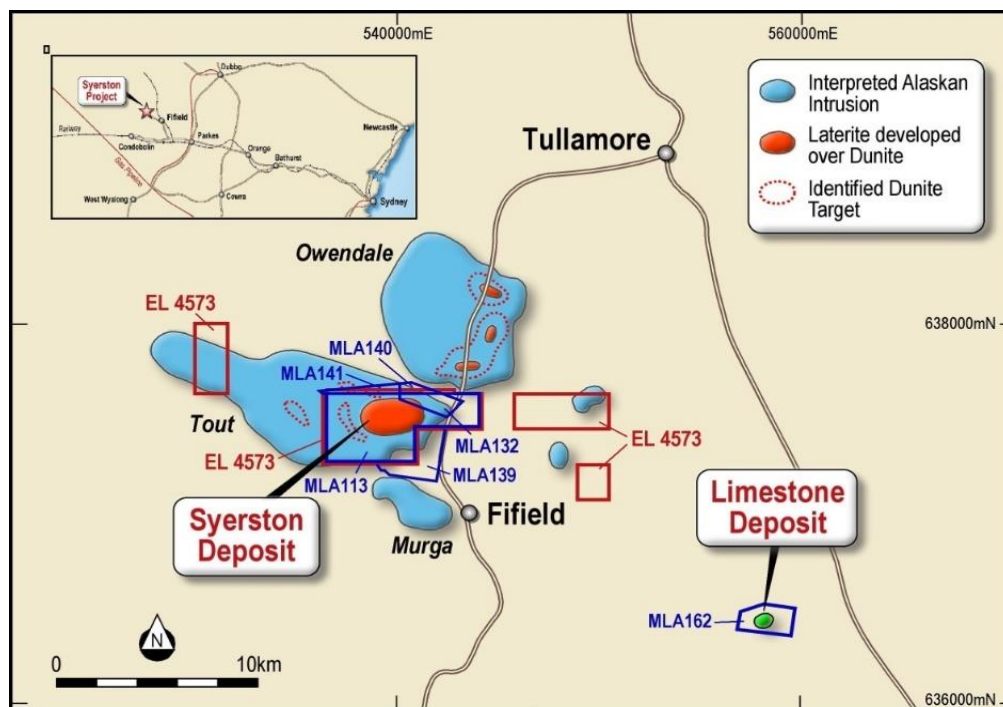

Extensive historic drilling has been undertaken by previous owners of the Syerston Project to identify the potential for economic nickel and cobalt mineralisation. The drilling comprises over 1,300 holes, which have enabled a comprehensive assessment of variability across the mineralised area, as well as the completion of metallurgical test work to identify the leaching characteristics.

**Figure 3: Syerston Nickel/Cobalt Mineral Resource Area**

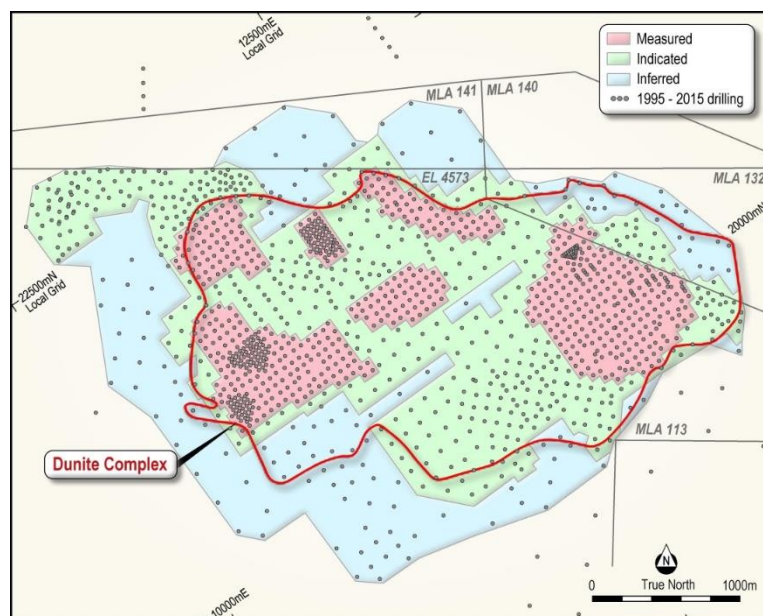

### **Nickel and Cobalt in the Lithium-Ion Battery Market**

Cobalt and nickel are critical raw materials in the production of cathodes for the lithium-ion battery (LiB) market. These metals are used in the production of precursor materials, which are converted to cathode active material for use in the batteries.

The battery industry requires nickel and cobalt to be supplied in specific chemical form for production of precursor material. In the case of both cobalt and nickel, this is generally in the form of hydrated metal sulphates ( $\text{CoSO}_4 \cdot 7\text{H}_2\text{O}$  and  $\text{NiSO}_4 \cdot 6\text{H}_2\text{O}$ ).

The demand for lithium-ion cells is anticipated to grow strongly over the next decade as production of electric vehicles increases and batteries become an important component in utility-scale energy storage systems.

Syerston's high cobalt grades, combined with Clean TeQ's proprietary ion exchange technology to produce the specific cobalt and nickel sulphates required by lithium-ion cell manufacturers, positions the Company to benefit from strong forecast growth in demand for LiB's.

The global LiB market has grown at a 20% compound annual growth rate (CAGR) over the last 10 years<sup>4</sup>, mainly due to the steady growth in portable electronic devices (laptops, smartphones, etc) and, more recently, the emergence of automotive applications. Forecasts for LiB demand growth vary, but even the most conservative estimates are predicting LiB demand to experience rapid growth over the next 10 years.

<sup>4</sup> Source: Avicenne Energy Analysis 2014

**Figure 4: Historic and Forecast Global LiB Sales ('GWh) <sup>4</sup>**

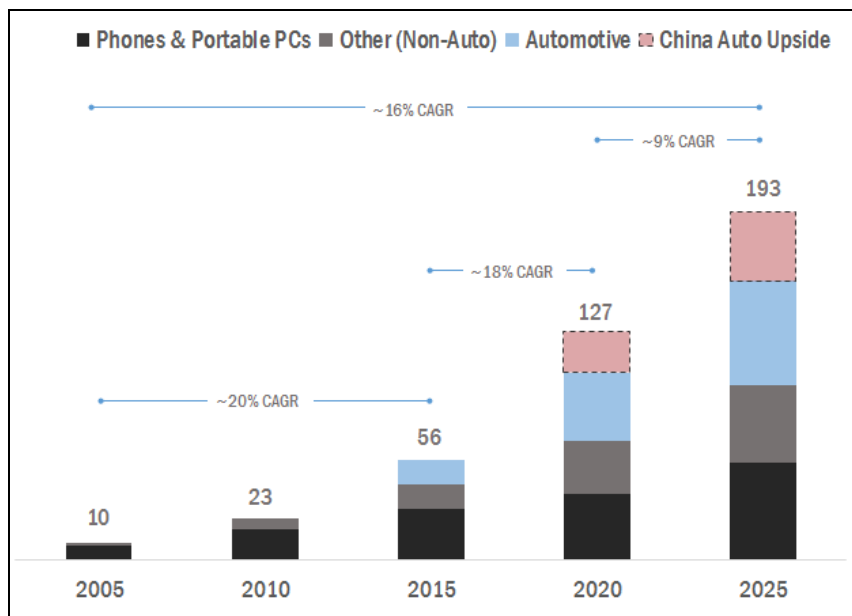

Much of the current acceleration in demand for LiB's is resulting from their use in electric vehicles. From approximately 0.5 million plug-in hybrid electric vehicles (**PHEV**) and battery electric vehicles (**BEV**) sold in 2015, demand is forecast to grow to 2 million units by 2020 and 6 million units by 2025 (see Figure 5). As battery costs fall, BEV drivetrains with higher capacity batteries are expected to replace PHEV's and hybrid electric vehicles (**HEV**), further adding to demand for key raw materials.

**Figure 5: Forecast Global x-EV Sales (2014 – 2025) <sup>5</sup>**

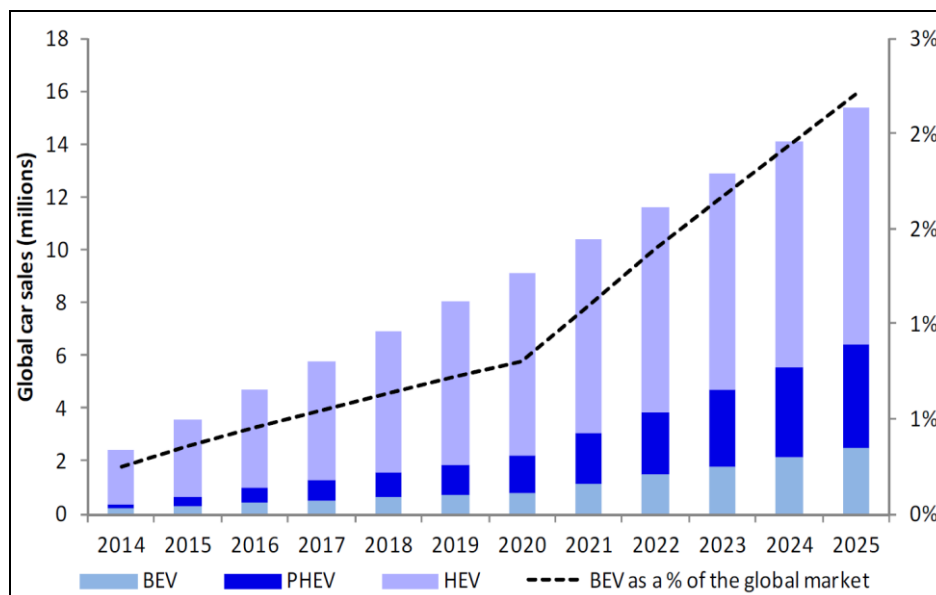

<sup>5</sup> Source: Deutsche Bank research 2016

## Lithium-Ion Battery Chemistries

Lithium ion cells contain a positive and a negative electrode. The positive electrode (cathode) is made of various formulations or 'chemistries' of oxidized metals. The negative electrode is generally made of carbonaceous material (natural and synthetic graphite). When the battery is charged, ions of lithium move through an electrolyte from the cathode to the anode and attach to the carbon. During discharge, the lithium ions move back from the carbon anode to the cathode (See Figure 6).

The different battery types or 'chemistries' are defined by the compositions of their metalliferous cathodes. There are five main battery chemistries which comprise the majority of the LiB market. Of those, lithium-cobalt-oxide (**LCO**) is the dominant battery in portable electronic devices. The nickel-cobalt-manganese (**NCM**) and nickel-cobalt-aluminium (**NCA**) chemistries are increasingly becoming the industry standard for electric vehicle applications, due to their high energy density.

Figure 6: Rechargeable LiB Cell<sup>6</sup>

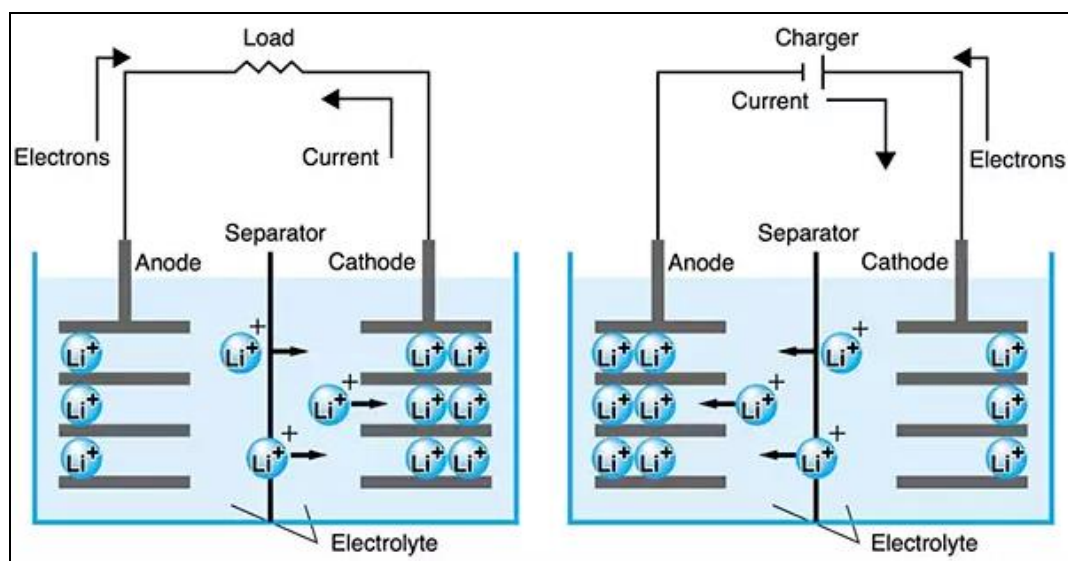

In recent years, China's automotive industry has favored adoption of lithium-iron-phosphate (**LFP**) and lithium-magnesium oxide (**LMO**) battery chemistries. However, there is a clear global trend to the adoption of NCM and NCA chemistry due to their higher energy densities, increased life cycle and the auto industry's preference for passenger vehicles with longer range. Significant growth in the LiB sector is expected to come from NCM and NCA chemistries, both of which can contain relatively high nickel and cobalt content.

<sup>6</sup> Source: Stephen Evanczuk, DigiKey Electronics



**Figure 7: LiB Chemistry Market Share<sup>7</sup>**

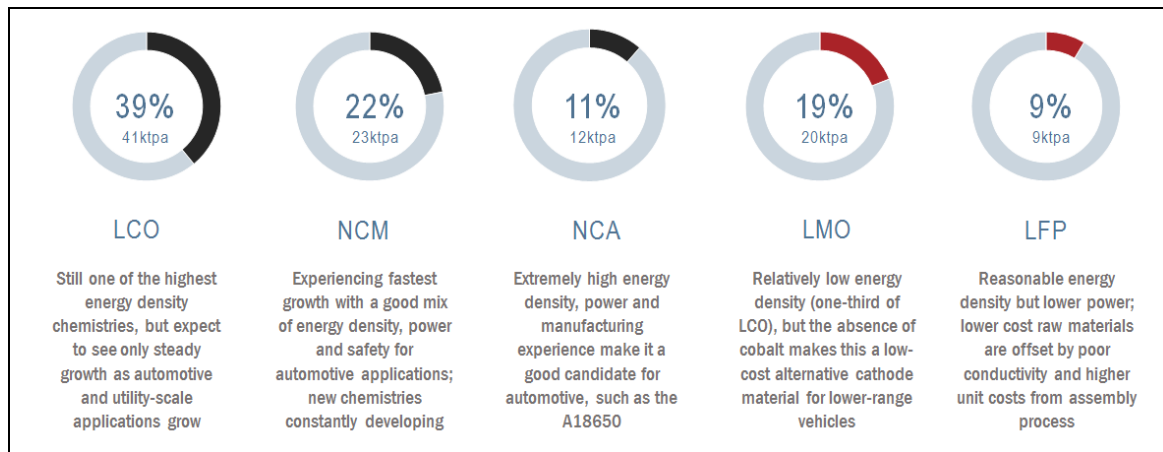

LiB cathode production requires high purity precursor materials to ensure high performance and extended battery life. NCA and NCM battery chemistries require high purity nickel sulphate ( $\text{NiSO}_4 \cdot 6\text{H}_2\text{O}$ ) and cobalt sulphate ( $\text{CoSO}_4 \cdot 7\text{H}_2\text{O}$ ) to produce precursor materials. LCO battery chemistry requires cobalt oxide.

### **Cathode is Critical to Battery Cost and Performance**

The cathode is fundamentally important to both the performance and cost-competitiveness of a lithium-ion cell. Raw materials can represent 50%–70% of the cost of manufacturing a lithium-ion cell, depending on the chemistry adopted. As such, nickel and cobalt can represent as much as 80% of the metal cost in the cathode, or approximately 20% of the total cell cost (see Figure 8).

The predicted growth in the LiB market means that a considerable amount of high grade nickel sulphate and cobalt sulphate will be required over the next ten years. As such, reliable and cost-competitive nickel and cobalt supply has an important role to play in the future of LiB's (see Figure 9).

While there is a large and established market for nickel which is driven by the global steel sector, almost all of the world's cobalt is produced as a by-product from nickel and copper mines. For this reason, cobalt stands apart as one of the few metals consumed at industrial-scale that has almost no source of primary supply. Global refined production in 2015 was in the order of 90,000 tonnes<sup>8</sup> of contained cobalt, a large portion of which was exported to, and processed in, China. In order to meet the demands of the growing LiB market, there will need to be a significant increase in global supply of cobalt. At a time when nickel and copper prices are at or near long-term historic lows, this presents real challenges for cobalt supply, as seen in recent or pending mine and refinery closures in Africa (Katanga Mining) and Australia (QNI).

<sup>7</sup> Source: Avicenne Energy Analysis 2014

<sup>8</sup> Source: Darton Commodities, "Global Cobalt Review, 2015–2016"

**Figure 8: Estimated NCM Cell Cost Breakdown<sup>9</sup>**

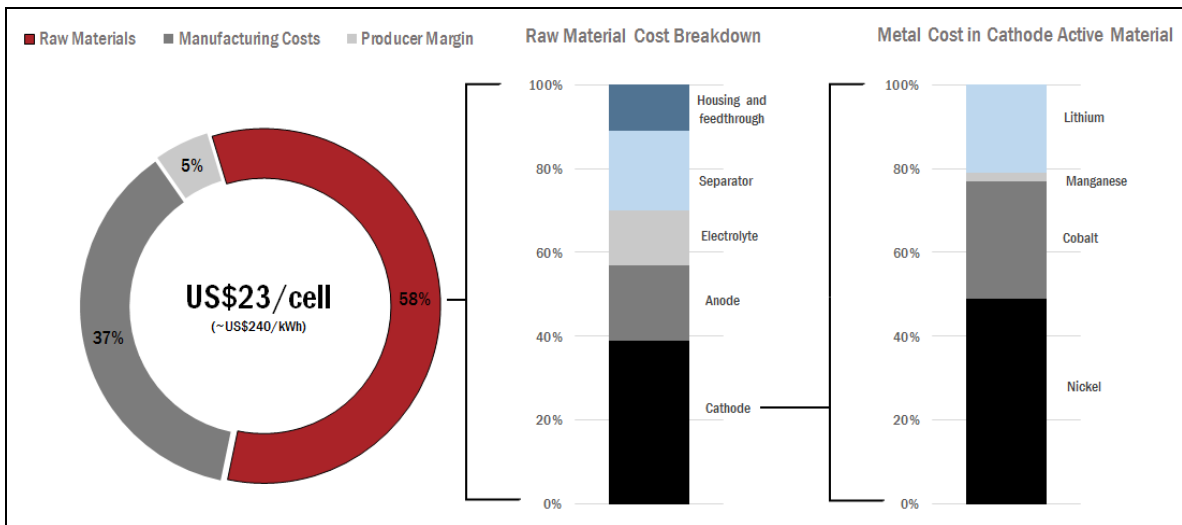

**Figure 9: LiB Cathode Raw Material Demand<sup>10</sup>**

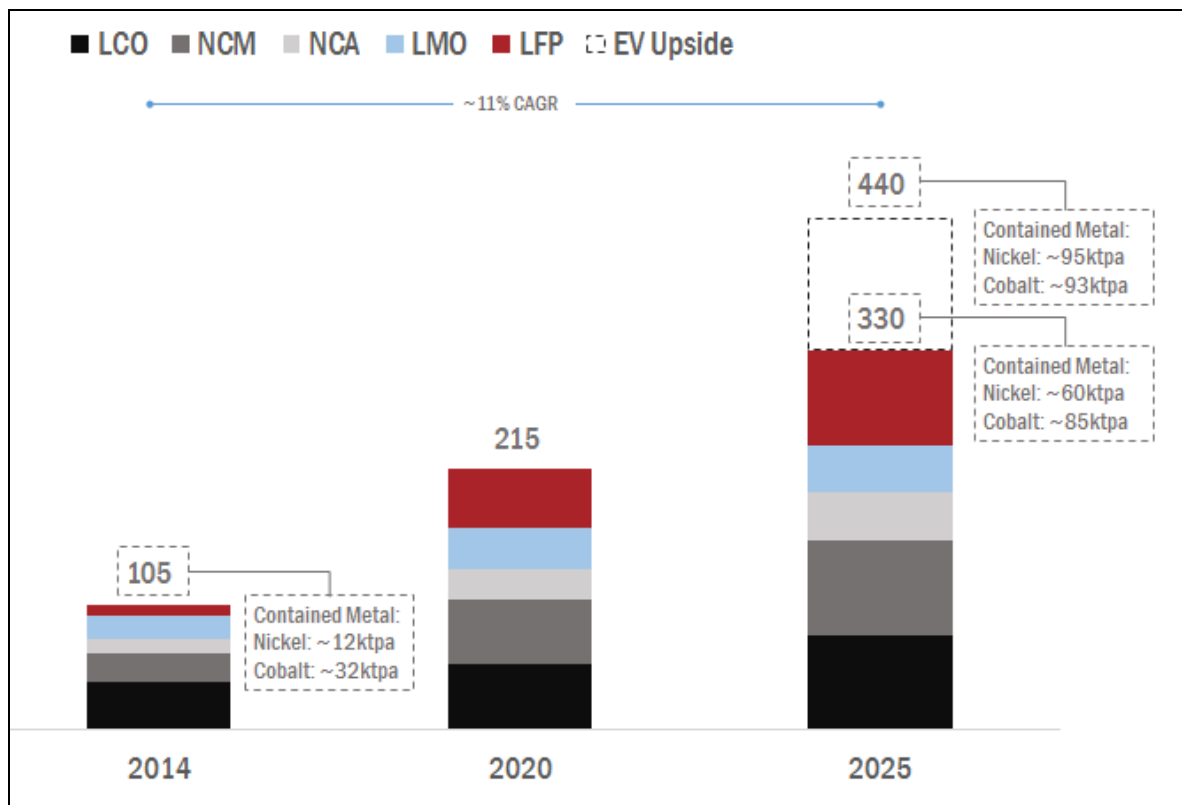

<sup>9</sup> Source: Roland Berger (2012) and internal analysis. Assumes a 96Wh PHEV cell (26Ah, 3.7W) using NCM622 cathode chemistry. Cathode cost includes non-metallic materials (carbon black, binder, foil). Internal assumptions concerning split of costs assumes average long-term prices of Ni US\$7.00/lb; Co US\$12.00/lb; Mn US\$1.00/lb; Li US\$6.50/kg (as LCE).

<sup>10</sup> Source: Avicenne Energy Analysis 2014. EV Upside based on Avicenne upside case for 2025 of 2.6m units of EV sales. Metal demand based on internal Clean TeQ estimates.

In addition to the risk through by-product dependence, global cobalt supply is heavily concentrated in the Democratic Republic of Congo (DRC). In 2015 production sources in the DRC represented 65% of global mined cobalt supply. A large portion of this production was from artisanal mining operations involving child labour.<sup>11</sup> While cobalt is not listed as a 'conflict mineral', the LiB industry is under increasing pressure to demonstrate an auditable cobalt supply chain to ensure that responsible procurement practices are adopted.

A recent report by Amnesty International and Afreewatch, *"This is what we die for: Human rights abuses in the Democratic Republic of the Congo power the global trade in cobalt"*, highlighted the child labour practices adopted in many of the artisanal mines and urged the global electronics and automotive industries to provide better auditing of their supply chains. See:

[http://www.amnesty.org.au/images/uploads/about/Amnesty\\_report\\_2016\\_Human\\_rights\\_abuses\\_in\\_DRC\\_power\\_global\\_cobalt\\_trade.pdf](http://www.amnesty.org.au/images/uploads/about/Amnesty_report_2016_Human_rights_abuses_in_DRC_power_global_cobalt_trade.pdf)

### **Nickel/Cobalt Project Prefeasibility Study**

Clean TeQ is currently completing a Prefeasibility Study (**PFS**) based on the Updated Mineral Resource Estimate to determine the potential viability of a large-scale development to produce high-quality nickel sulphate and cobalt sulphate to supply growing demand from the LiB industry. The PFS data is derived, in large part, from an update to the previous Feasibility Study. The PFS is on track to be completed by the end of September.

As the Mineral Resource contains scandium, the PFS will also assess the impact of producing scandium oxide as a by-product to meet anticipated future demand for lightweight alloys for the global transportation sector. The PFS will allow the Company to compare the economics of the larger Nickel/Cobalt Project against the small-scale primary scandium mine, which is in the final stages of a Feasibility Study due for completion in September 2016.

The PFS will assume a flow sheet adopting high pressure acid leaching of ore followed by Clean TeQ's Resin-In-Pulp (**RIP**) process to extract and recover high-value nickel sulphate and cobalt sulphate products, rather than using solid-liquid separation and mixed sulphide or hydroxide precipitation to produce a low-value mixed nickel/cobalt product typically produced in conventional flowsheets. This has the potential to significantly reduce the number of production processes required to manufacture high-purity cathode raw material for the lithium-ion battery industry, as well as providing customers with a fully-auditable supply chain of raw materials back to mine source.

---

<sup>11</sup> Source: Darton Commodities, "Global Cobalt Review, 2015-2016"

**Figure 10: Clean TeQ's proprietary Resin-In-Pulp (cRIP) process demonstration plant, which can be used for production of NiSO<sub>4</sub> and CoSO<sub>4</sub> samples for customer testing**



### **Extraction of Nickel and Cobalt Using Ion Exchange**

Clean TeQ has extensive experience in development, testing and piloting of RIP for recovery of nickel and cobalt from lateritic ores. A detailed programme of research and testwork, including construction and operation of a comprehensive pilot plant operation, was undertaken by Clean TeQ between 2007 and 2009. The programme successfully demonstrated the RIP technology as an effective process for the recovery of nickel and cobalt from lateritic leach slurries. Clean TeQ owns this pilot plant which was used as the demonstration plant for the scandium recovery testwork in 2015 (see Figure 10 above).

As outlined above, cathode manufacture requires high-purity metal salts, in the form of chemical grade nickel and cobalt sulphate, rather than nickel and cobalt metal. As the RIP and elution process naturally produces a highly concentrated and pure nickel and cobalt sulphate stream, the downstream purification, separation and production of high-quality products at the mine site offers a potentially unique and simplified proposition for supplying the LiB industry.

The PFS will also seek to validate the results from the earlier feasibility study, which assessed the impact of Syerston's unique ore characteristics. Syerston ore is differentiated from typical clay-hosted laterite projects in a number of ways. In particular, it is a limonitic deposit consisting predominantly of goethite (high iron, low clay) that is low in acid-consuming elements such as calcium and magnesium. Extensive metallurgical and leaching testwork undertaken as part of the previous feasibility studies demonstrated that the limonitic nature of the ore results in low acid consumption. As sulphuric acid is typically a major operating cost for laterite operations, a low acid consuming ore may provide significant operating cost advantages.

The limonitic nature of the ore also results in a low viscosity slurry. A low viscosity leachate slurry 'flows' better through the process, allowing for more concentrated solutions and therefore, lower overall volumes of throughput. This provides potential for smaller sized plants.

The relatively dry climate of the region is also amenable to residue disposal to conventional tailings storage facilities and evaporation ponds. Syerston is likely to be supplied with low-chloride raw water which will minimise materials/corrosion costs within the plant. The area is also well serviced with excellent infrastructure and is recognised globally as having low political risk.

The PFS will include a high level review by SNC Lavalin, who completed the prior feasibility study by Ivanplats, of key cost assumptions to determine any variations in costs from the previous studies.

Clean TeQ has commenced discussions with a number of key participants in the lithium-ion battery industry to assess potential demand for nickel and cobalt sulphate from the Syerston Nickel/Cobalt Project. These participants include precursor and cathode manufacturers, LiB cell and battery manufacturers and end users of LiB batteries, as well as metals/chemicals traders. To date the Company has received strong initial expressions of interest for offtake of Syerston nickel sulphate and cobalt sulphate products. Work is underway for recommissioning the pilot plant within the next few months to produce samples for customer testing purposes.

**For more information about Clean TeQ, contact:**

Sam Riggall, Executive Chairman or Ben Stockdale, CFO

+61 3 9797 6700

**About Clean TeQ Holdings Limited (ASX: CLQ)** – Based in Melbourne, Clean TeQ, using its proprietary Clean-iX<sup>®</sup> continuous ion exchange technology, is a leader in metals recovery and industrial water treatment.

For more information about Clean TeQ please visit the Company's website at [www.cleanteq.com](http://www.cleanteq.com).

**About the Syerston Project** – Clean TeQ is the 100% owner of the Syerston Project, located in New South Wales. The Syerston Project has the potential to be a key global supplier of nickel, cobalt and scandium raw materials. The Syerston Scandium Project Feasibility Study is currently underway and expected to be completed in September 2016. A larger scale nickel, cobalt and scandium project is currently being evaluated.

*The information in this document that relates to nickel-cobalt Mineral Resources is based on information compiled by Diederik Speijers and John McDonald, who are Fellows of The Australasian Institute of Mining & Metallurgy and employees of McDonald Speijers. Diederik Speijers and John McDonald have sufficient experience that is relevant to the style of mineralisation and type of deposit under consideration and to the activity which they are undertaking to qualify as Competent Persons as defined in the 2012 Edition of the 'Australasian Code for Reporting of Exploration Results, Mineral Resources and Ore Reserves'. Diederik Speijers and John McDonald, who are consultants to the Company, consent to the inclusion in the report of the matters based on their information in the form and context in which it appears.*

*The information in this document that relates to scandium Mineral Resources is based on information compiled by Sharron Sylvester, who is a Member and Registered Professional of the Australian Institute of Geoscientists and is an employee of OreWin Pty Ltd. Sharron Sylvester has sufficient experience that is relevant to the style of mineralisation and type of deposit*

**Clean TeQ Holdings Limited**

ABN 34 127 457 916

Ferntree Business Park  
12/21 Howleys Rd, Notting Hill VIC Australia 3168  
PO Box 227, Mulgrave VIC 3170 Australia  
T: +61 3 9797 6700 F: +61 3 9706 8344  
W: [www.cleanteq.com](http://www.cleanteq.com) E: [Info@cleanteq.com](mailto:Info@cleanteq.com)

*under consideration and to the activity which she is undertaking to qualify as a Competent Person as defined in the 2012 Edition of the 'Australasian Code for Reporting of Exploration Results, Mineral Resources and Ore Reserves'. Sharron Sylvester, who is a consultant to the Company, consents to the inclusion in the report of the matters based on their information in the form and context in which it appears.*

*This release may contain forward-looking statements. The actual results could differ materially from a conclusion, forecast or projection in the forward-looking information. Certain material factors or assumptions were applied in drawing a conclusion or making a forecast or projection as reflected in the forward-looking information.*

# Syerston Mineral Resource Statement Technical Overview

## 1 Resource Statement

McDonald Speijers Pty Ltd (“McDonald Speijers”) has completed a nickel (Ni) and cobalt (Co) Mineral Resource estimate for the Syerston Project, located in New South Wales. The resource incorporates revision of the previous nickel and cobalt mineral resource, and has been prepared according to the guidelines of the Australasian Code for the Reporting of Exploration Results, Mineral Resources and Ore Reserves (the JORC Code), 2012 Edition.

The following table provides a summary of the Mineral Resource Estimate.

**Table 3: Syerston Summary Nickel/Cobalt Mineral Resource Estimate, 0.60%NiEQ Cut-off<sup>12</sup>**

Classification Category	Tonnage (Mt)	Ni Grade %	Co Grade %	Ni Metal Tonnes	Co Metal Tonnes
Measured	52	0.73	0.11	380,000	57,000
Indicated	49	0.58	0.10	280,000	49,000
<b>Meas + Ind</b>	<b>101</b>	<b>0.65</b>	<b>0.10</b>	<b>660,000</b>	<b>106,000</b>
Inferred	8	0.54	0.10	50,000	8,000
<b>Total</b>	<b>109</b>	<b>0.65</b>	<b>0.10</b>	<b>700,000</b>	<b>114,000</b>

Notes: Any apparent arithmetic discrepancies are due to rounding  
 NiEQ = nickel equivalent Mt = million tonnes

In addition to nickel and cobalt, a range of accessory elements were included in the estimation process. For the purposes of the nickel/cobalt resource estimate none of these were treated as potential economic by-products and none were taken into account in calculating nickel equivalent (NiEQ) values for cut-off grade application. The accessory elements were not subjected to the same level of technical scrutiny as nickel and cobalt, particularly in relation to sampling and assaying quality controls.

The following table provides a summary of the current resource estimate at a range of different nickel equivalent cut-off grades, including selected accessory elements.

<sup>12</sup> NiEQ cut-off was calculated as  $NiEQ\% = Ni\% + (Co\% \times 2.95)$ , based on assumed metal prices of US\$4.00/lb Ni, US\$12/lb Co, at USD:AUD exchange rate of 0.70. NiEQ was calculated on Ni and Co only, with no consideration for scandium and platinum.

**Table 4: Updated Mineral Resource Estimate at a range of cut-off<sup>1</sup> grades**

Cut-off NiEQ %	Classification Category	Tonnage (Mt)	Grades								
			Ni %	Co %	Accessory Elements						
					Pt g/t	Sc* ppm	Fe %	Al %	Ca %	Mg %	Mn %
0.6	Measured	52	0.73	0.11	0.20	51	35	2.5	0.38	1.3	0.80
0.6	Indicated	49	0.58	0.10	0.21	56	35	2.3	0.40	1.2	0.70
<b>0.6</b>	<b>Meas + Ind</b>	<b>101</b>	<b>0.65</b>	<b>0.10</b>	<b>0.21</b>	<b>54</b>	<b>35</b>	<b>2.4</b>	<b>0.39</b>	<b>1.2</b>	<b>0.75</b>
0.6	Inferred	8	0.54	0.10	0.16	78	36	2.8	0.38	1.4	0.78
<b>0.6</b>	<b>Total</b>	<b>109</b>	<b>0.65</b>	<b>0.10</b>	<b>0.20</b>	<b>56</b>	<b>35</b>	<b>2.4</b>	<b>0.39</b>	<b>1.2</b>	<b>0.75</b>
0.8	Measured	37	0.81	0.13	0.21	53	37	2.5	0.28	1.1	0.93
0.8	Indicated	26	0.66	0.13	0.23	53	37	2.3	0.30	1.0	0.87
<b>0.8</b>	<b>Meas + Ind</b>	<b>64</b>	<b>0.75</b>	<b>0.13</b>	<b>0.22</b>	<b>53</b>	<b>37</b>	<b>2.4</b>	<b>0.29</b>	<b>1.1</b>	<b>0.90</b>
0.8	Inferred	4	0.66	0.12	0.18	65	39	2.5	0.22	1.0	0.93
<b>0.8</b>	<b>Total</b>	<b>67</b>	<b>0.74</b>	<b>0.13</b>	<b>0.22</b>	<b>53</b>	<b>37</b>	<b>2.4</b>	<b>0.29</b>	<b>1.1</b>	<b>0.90</b>
1.0	Measured	25	0.90	0.15	0.22	54	39	2.5	0.22	1.0	1.07
1.0	Indicated	12	0.74	0.16	0.26	50	39	2.4	0.24	0.9	1.08
<b>1.0</b>	<b>Meas + Ind</b>	<b>36</b>	<b>0.85</b>	<b>0.16</b>	<b>0.24</b>	<b>53</b>	<b>39</b>	<b>2.5</b>	<b>0.23</b>	<b>1.0</b>	<b>1.07</b>
1.0	Inferred	2	0.75	0.14	0.20	57	42	2.4	0.13	0.8	1.04
<b>1.0</b>	<b>Total</b>	<b>38</b>	<b>0.84</b>	<b>0.15</b>	<b>0.23</b>	<b>53</b>	<b>39</b>	<b>2.5</b>	<b>0.23</b>	<b>1.0</b>	<b>1.07</b>

Notes: Any apparent arithmetic discrepancies are due to rounding

NiEQ = nickel equivalent

g/t = grams per tonne

ppm = parts per million

\*Scandium grades estimated independently by OreWin Pty Ltd

About 97% of the drill hole data accepted for use in resource grade estimation are dated from mid-1997 or later. Recent drilling programmes in 2014–2015 contributed only some 8% of holes deemed acceptable for use in resource estimation.

The key features of the resource estimate are:

- The final classification resulted in 48% of the total volume being categorised as Measured, 45% as Indicated, and 7% as Inferred.
- There is the potential to include by-product low-grade scandium into a nickel/cobalt operation, as it is relatively consistent through the deposit.

Figure 1 shows the nickel and cobalt contained within the defined resource as a function of cut-off grade. The nickel and cobalt grades for each cut-off are also indicated. Figure 12 outlines the classification zones over the resource area.



**Figure 11: Contained nickel and cobalt resource and grade for a range of cut-off grades**

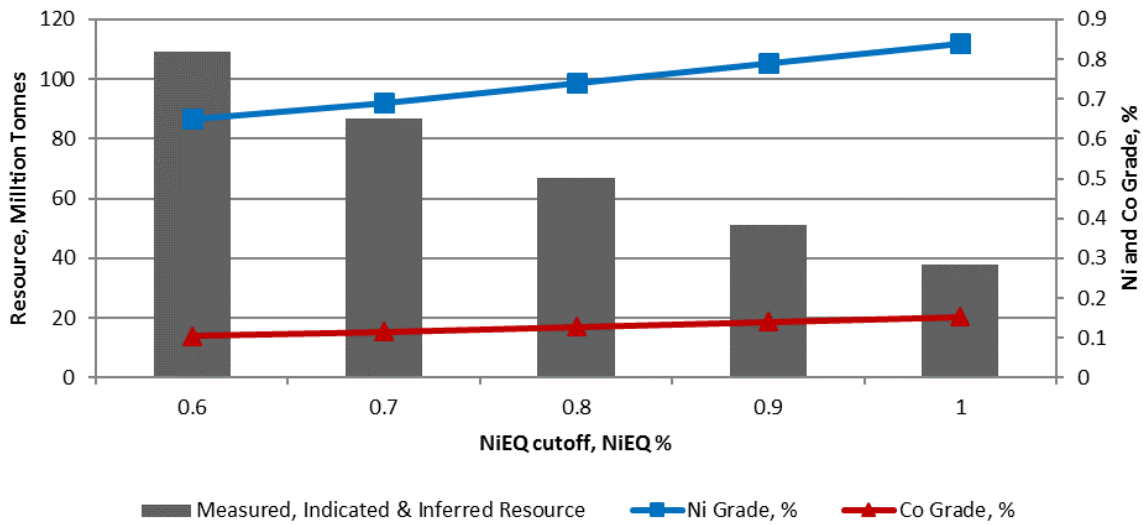

**Figure 12: Syerston Cobalt/Nickel Mineral Resource Area**

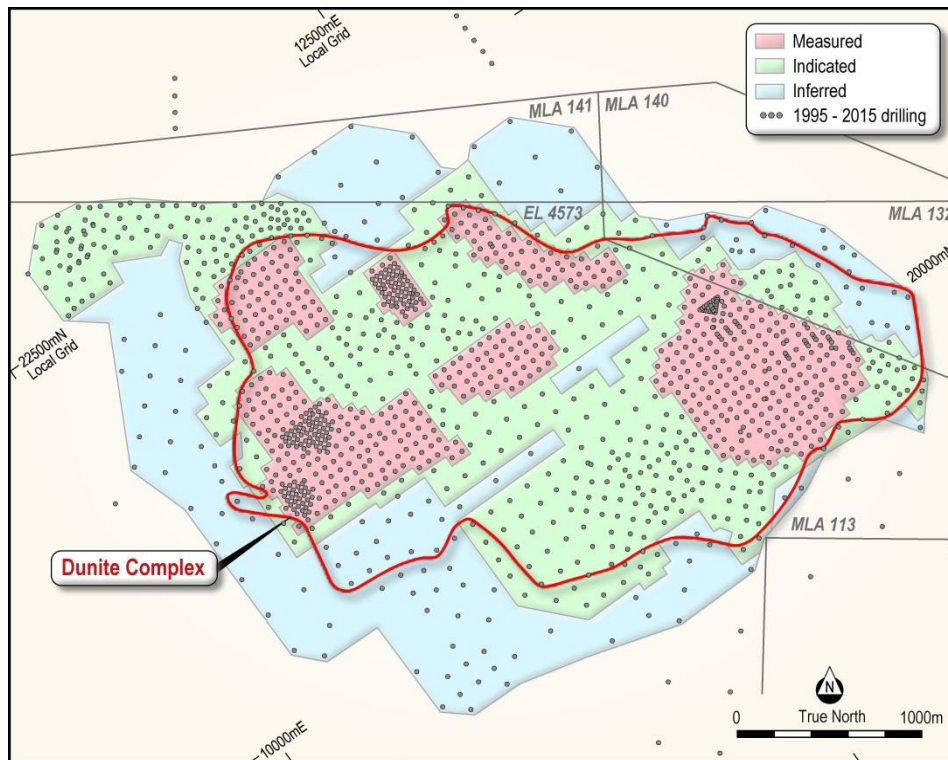

Reasonable prospects for eventual economic extraction of the mineral resource are supported by:

- Anticipated low mining costs as a result of the near-surface nature of the mineralisation.
- Amenability to leaching using sulphuric acid at high-temperature and pressure as demonstrated in both the historical and scandium-related metallurgical test work. High-pressure acid leaching is a recognised and widely-used method for the liberation of metals from lateritic ores.

- The nickel and cobalt are generally associated with mineralisation containing relatively low amounts of gangue minerals, meaning acid consumption is expected to be low.
- The ability to utilise Resin-In-Pulp (**RIP**) technology to produce a nickel and cobalt sulphate liquor at a reasonably high purity which is amenable to simple purification and crystallization processes to produce high quality hydrated nickel sulphate ( $\text{NiSO}_4 \cdot 6\text{H}_2\text{O}$ ) and cobalt sulphate ( $\text{CoSO}_4 \cdot 7\text{H}_2\text{O}$ ) products.

### **Note Relating to Scandium**

Prior to 2014, scandium was regarded as one of several minor accessory elements present in the laterite profile at Syerston. Since acquiring the Project, Clean TeQ has pursued its interest in the potential for development of the scandium mineralisation. The nickel and cobalt resource area contains a noteworthy endowment of background-grade scandium, as well as a minor contribution from localized zones of high-grade scandium that occur mostly, but not exclusively, around the periphery of the nickel/cobalt resource area. While the average scandium grade over the deposit is low, the potential to generate significant by-product revenues from scandium oxide production, for a relatively minor incremental cost, could add substantial by-product credits to a nickel/cobalt development.

In early 2016, Clean TeQ commissioned OreWin Pty Ltd to develop an independent resource estimate for high-grade scandium, with the aim of assessing whether the high-grade scandium may be considered as a standalone project. The results of this work were announced to the ASX on 17<sup>th</sup> March 2016. In mid-2016, Clean TeQ commissioned OreWin Pty Ltd to update the background scandium model throughout the nickel/cobalt resource area. The estimated scandium reported in the nickel/cobalt resource that is the subject of this current announcement is largely comprised of low-grade background scandium that is considered to be accessory to the nickel/cobalt resource and not standalone scandium resource in its own right. Only a small proportion (less than 10%) of the previously announced scandium Mineral Resource (17<sup>th</sup> March 2016) is contained within the current nickel/cobalt Mineral Resource at the quoted NiEq cut-off. The scandium Mineral Resource from 17<sup>th</sup> March 2016 remains unchanged.

## **2 Project Overview**

### **2.1 Project Location**

The Syerston Project is located 4 km from the regional town of Fifield (350 km north-west of Sydney). The Fifield District is noted for its intense magnetic anomalism and significant occurrences of minerals containing platinum, nickel, cobalt, and scandium.

**Figure 13: Location of the Syerston Exploration Licence and Mining Licence Applications in the Fifield District (AGD84).**

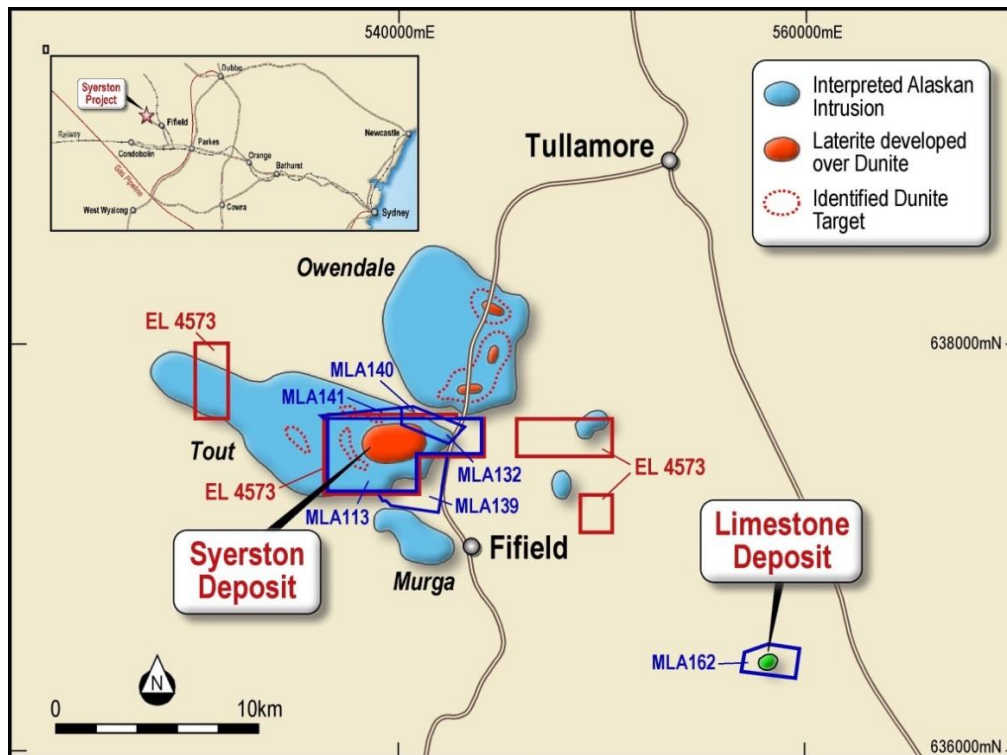

## 2.2 Tenements / Licences

The Project lies within EL 4573. Several MLA's overlay the same project area (shown in Figure 13 above). The project also contains a limestone deposit to the south-east, as well as an established bore field with water rights to the south.

Scandium21 Pty Ltd, a wholly owned subsidiary of Clean TeQ, has 100% ownership of the EL and MLA's. A list of these is provided in Table .

**Table 5: Syerston Project Tenement Summary (see figure above)**

Licence No.	Area	Application Date	Status	Interest	Holder
EL 4573	c. 57 sq km (4 parts)	--	granted	100%	Scandium21 Pty
MLA 113	8 units (c. 24 sq km)	10 August 1998	pending	100%	Scandium21 Pty
MLA 132	200 Ha	20 September 1999	pending	100%	Scandium21 Pty
MLA 139	421.0488 Ha	10 December 1999	pending	100%	Scandium21 Pty
MLA 140	77.7845 Ha	10 December 1999	pending	100%	Scandium21 Pty
MLA 141	137.5524 Ha	10 December 1999	pending	100%	Scandium21 Pty
MLA 162	390 Ha	27 September 2000	pending	100%	Scandium21 Pty

Clean TeQ owns the freehold land under a large portion the project area, as well as a 3.2GL p.a. water licence to the south of the project. Water is a critical part of any project in the region due to limited availability. Therefore, having this water licence provides a significant advantage for the project.

There is also a pre-existing Development Consent in place with the NSW government relating to the Syerston Nickel/Cobalt project for a plant with a throughput rate up to 2.5Mtpa, providing one of the key approvals required to develop the project. This was lodged after an Environmental Impact Statement (**EIS**) was completed and lodged with the NSW government in 2000.

### **2.3 Project and Exploration History**

The Fifield District remains the location of Australia's only historic source of platinum production, with approximately 20,000 ounces of the metal being extracted from deep leads between 1887 and the mid-1960s. Despite promising indications, few companies have succeeded in identifying economic grades of platinum mineralisation.

The Syerston deposit has been subjected to multiple drilling programmes by five different owners since 1988.

In 2000, SNC-Lavalin completed a Feasibility Study for Black Range Minerals NL (**BRM**), then owner of the project. The study focused on a variety of development options for a nickel laterite operation and throughout 2002 and 2003 work focused on project financing. The project gained development approval from the NSW government in 2001.

In 2004, Ivanplats acquired the project from **BRM** and continued to progress development studies for the resource, focusing principally on extracting nickel and cobalt from the laterite. As part of its studies, it completed an in-fill RC drill programme comprising 174 holes over 6,748 metres. The drill samples were assayed for a range of elements including nickel, cobalt, platinum, and scandium. During this time, Ivanplats completed further piloting of the entire process flow sheet.

In 2005 Ivanplats completed a revised Feasibility Study with SNC-Lavalin, based on the additional piloting work and drilling results. Also at this time, a modified development approval was obtained reflecting the changes in the project. In May 2006, the development consent was triggered on the project. The project did not proceed to full development due to the prevailing base metal prices at the time.

In 2014 Ivanplats conducted a small drilling programme to investigate scandium potential on the northern fringes of the nickel/cobalt resource.

Figure 14 provides an overview of the drilling campaigns completed over the Project area.

**Figure 14: Syerston Drilling Campaign Summary**

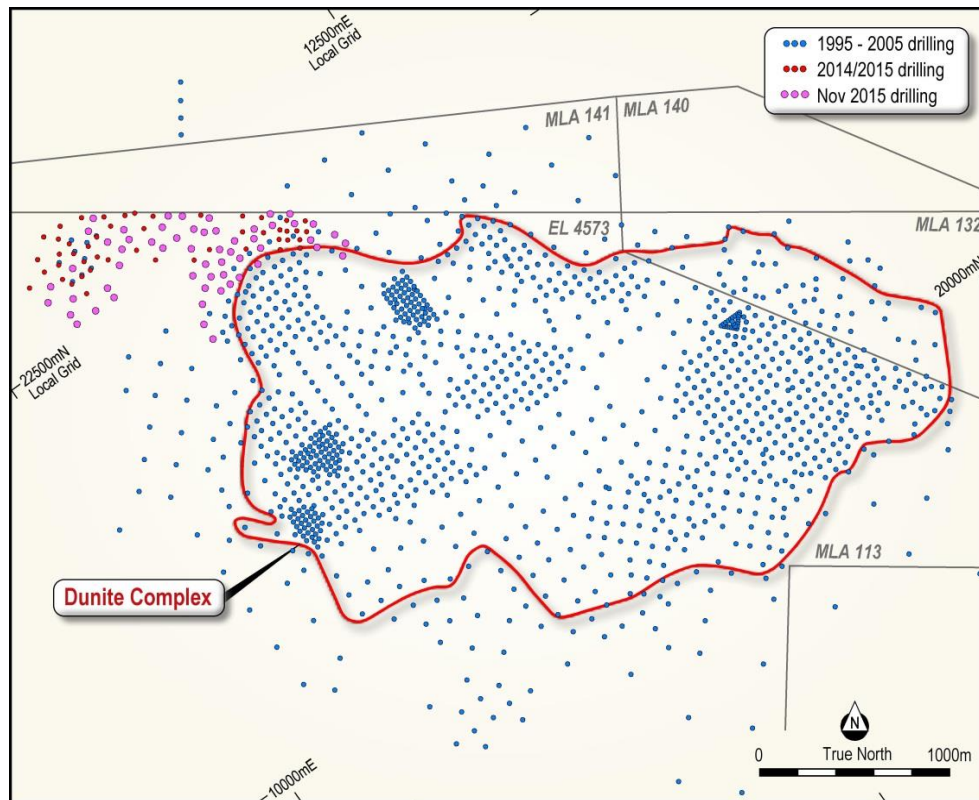

Clean TeQ, through its wholly owned subsidiary Scandium21 Pty Ltd, acquired the project from Ivanplats in March 2015 to focus on the development of Syerston for scandium. A scoping study was completed in May 2015 with a large scale demonstration plant on Syerston ore completed in the second half of 2015. In 2015, Scandium21 conducted two further programmes of localised infill and extension drilling to better delineate areas of potential scandium resources.

### 3 Project Geology

The Syerston Project is a typical surficial deposit hosted within a Tertiary age lateritic weathered profile. Enrichment of the metals of economic interest occurred during a secondary process ascribed principally to chemical weathering of the underlying ultramafic rocks. During weathering, selective leaching of more soluble elements such as magnesium and silica occurred, leaving a highly iron-enriched laterite residue enriched in base and precious metals. Further enrichment can occur during mechanical weathering or erosion.

Figure 15: Syerston Project Geology

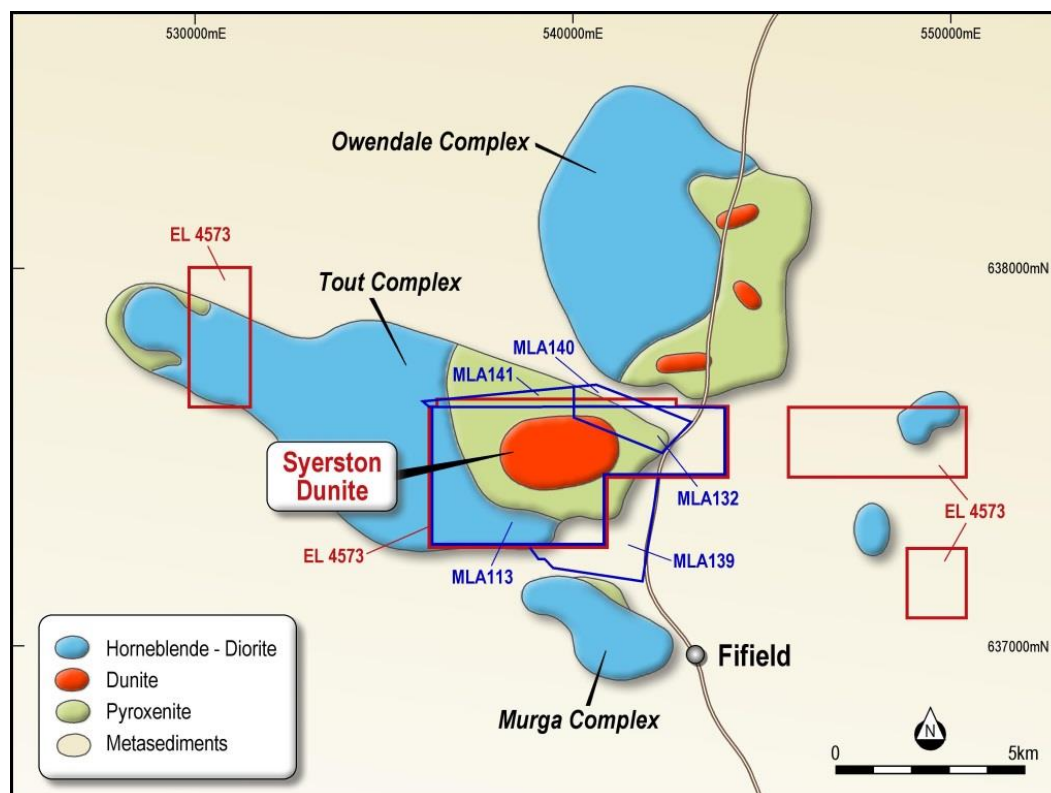

The Tout Ultramafic Complex is the intrusive body which underlies the laterite at the Syerston Project. The complex is concentrically zoned, with ultramafic rocks in the core grading to mafic material on the periphery. The laterite profile developed preferentially over a dunite core, covering an area of about 4 km by 2 km, which controls the location of the bulk of the nickel-cobalt mineral resource. Accelerated preferential weathering over the ultramafic core has resulted in the laterite profile reaching its maximum thickness of 35–40 m and thinning out laterally over surrounding mafic rocks.

### 3.1 Laterite Profile

Five zones have been recognised in the lateritic weathering profile, below any transported alluvial cover. From top to bottom these are:

#### 1. Residual Overburden (OVB)

Poorly mineralised, hematitic (commonly pisolitic) material immediately beneath any alluvial cover. Physically similar to the upper part of the underlying Transition Zone and distinguished from it only by low nickel values.

#### 2. Transition Zone (TZ)

Typically, a mixed zone grading from red-brown and hematitic (commonly pisolitic) near surface, or just beneath the alluvial cover, to an orange-brown goethitic material near the base. The top of this zone is defined purely on the basis of nickel grade.

### 3. Goethite Zone (GZ)

A relatively uniform, orange-brown layer, consisting mainly of extremely fine grained goethite. It typically contains more than 40% iron (Fe) and only 5-10% silicon (Si) occurring as silica (SiO<sub>2</sub>). Minor proportions of manganese (Mn) oxides are also generally present in this zone but absent in the TZ. This is the most strongly mineralised zone.

### 4. Silicified Goethite Zone (SGZ)

Distinguished from the overlying GZ by a rapid increase in silica content (Si values usually >15% and averaging over 20%). The silica is secondary, occurring as laminated veins or sub-horizontal bands and as irregular, coarse mesh works where it precipitated on joints and fractures. The matrix between the silica bands is predominantly fine goethite similar to the GZ. Grades are lower in this zone due to the diluting effect of the silica.

### 5. Saprolite Zone (SAP)

This is the strongly weathered top of the underlying bedrock. It usually consists mainly of clays, but relict igneous textures are preserved.

The typical form and relationships of the laterite zones are illustrated in Figure 16.

**Figure 16: Syerston Schematic Geological Section**

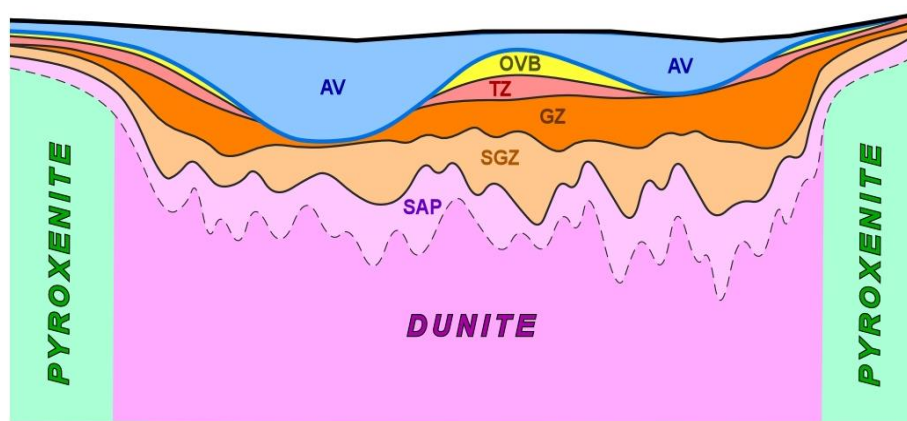

## 3.2 Mineralisation

Syerston is an iron-rich nickel laterite deposit with higher than normal levels of associated cobalt and local elevated platinum (Pt) values. For the most part nickel and cobalt are intimately incorporated in goethite and to a lesser degree, hematite. The clay content of the main mineralised zones at Syerston seems to be very low and nickel-bearing hydrated silicates such as garnierite, or clay minerals like smectite, appear to be more or less absent except perhaps in the SAP.

The highest nickel and cobalt grades generally occur in the highly ferruginous GZ, with somewhat lower grades in the overlying TZ and in the underlying SGZ. The SAP zone only rarely contains significant nickel and cobalt values, but some elevated platinum grades occur on a very localised basis.

Unusually high cobalt values tend to be closely associated with manganese oxides, predominantly in the GZ.

The bulk of the nickel/cobalt resource occurs in an area measuring about 3,000m local grid north-south by 3,500m east-west. The top of the main mineralised zones occurs at depths ranging from zero to about 25m below surface and they are typically about 5m to 25m in thickness. An example of a laterite zone cross section can be seen in Figure 17.

Although the Fifield district is known for alluvial platinum in "deep leads" there are almost no indications of platinum accumulations in the Tertiary alluvial channels that traverse the Syerston deposit. There are suggestions of some very localised potential for bedrock platinum mineralisation in the underlying ultramafic intrusions.

Along with nickel and cobalt, platinum has also been concentrated in the laterite profile. Where it has been physically identified it occurs as grains of ferroplatinum, but the spatial distribution of grades suggests that there has been substantial lateral dispersion of platinum, particularly in the Goethite zone. This implies significant chemical remobilisation during weathering, analogous to the secondary dispersion of gold in many Western Australian laterite deposits, so platinum may also occur in other forms.

Scandium is widely dispersed through the ferruginous laterite zones at moderately enriched but still low concentrations. Zones of substantially higher values mostly occur over pyroxenites, peripheral to the dunite core of the ultramafic complex, where the laterite profile is thinner and nickel/cobalt grades are usually lower. Scandium may be preferentially associated with aluminium oxides.

**Figure 17: Section 11200mE Laterite Zone Interpretations (vertical exaggeration = 5:1)**

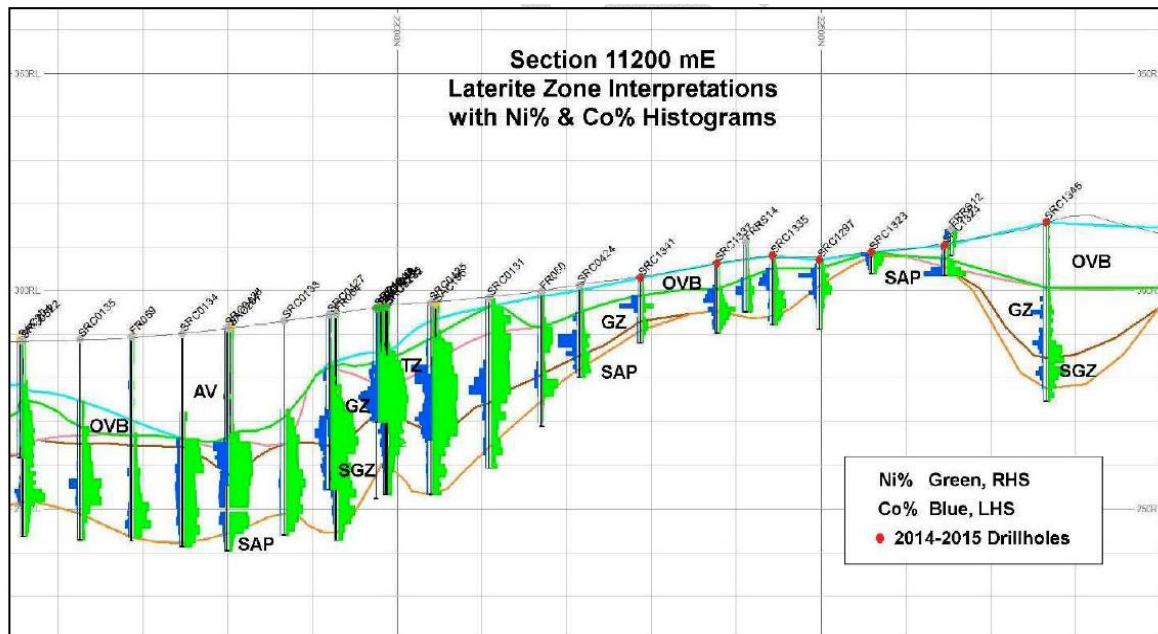



## 4 Mineral Resource Technical Details

A technical report has been prepared documenting the various aspects of the Mineral Resource Estimate which are summarised in the table below, prepared using the JORC (2012) Table 1 form:

**Table 6: JORC 2012 edition: Table 1 Report for Syerston Project Nickel/Cobalt Mineral Resource Estimate, June 2016**

### Section 1 Sampling Techniques and Data

Criteria	Commentary
<i>Sampling techniques</i>	<ul style="list-style-type: none"> <li>Available drill hole data was accumulated from multiple phases of drilling conducted by several operators over a period of more than 25 years, between 1988 and 2015. Due to the passage of time, some details of procedures followed during early phases of drilling are uncertain.</li> <li>The overwhelming bulk of data accepted for use in resource estimation was obtained by reverse circulation (RC) drilling, predominantly using face sampling hammers, but with a small proportion of aircore drilling. Cuttings were normally collected over 1m intervals. A very small proportion of holes were sampled over 2m intervals. Approximately 2-4 kg field samples were obtained by riffling and submitted to independent commercial laboratories for sample preparation and assaying. As recorded, procedures were consistent with normal industry practices.</li> </ul>
<i>Drilling techniques</i>	<ul style="list-style-type: none"> <li>Early programmes of rotary air blast (RAB) drilling were superseded by systematic patterns of vertical reverse circulation (RC) drilling, initially using aircore rigs, but predominantly using face sampling, down hole hammer bits with a nominal hole diameter of about 135mm.</li> <li>The overwhelming bulk of the RC drilling on which the resource estimate is based was carried out in 6 phases between 1997 and 2015, most of it in 2 major phases between 1997 and 2000. A total of 1,308 RC holes and 45 aircore holes were used for resource grade estimation.</li> <li>A total of 13 shallow, vertical diamond core holes were drilled between 1997 and 2000 to provide material for metallurgical test work and bulk density measurements.</li> <li>In 1999, nine large diameter (approximately 770 mm) holes were drilled with a Calweld rig to provide large samples for metallurgical test work and bulk density determination. Five (5) of the holes were bulk sampled to obtain Ni and Co grades.</li> </ul>
<i>Drill sample recovery</i>	<ul style="list-style-type: none"> <li>RC sample recoveries were recorded. Samples were weighed in 1998-2000, but the equipment used proved to be unsuitable and results were found to be unreliable. Recoveries were subsequently estimated by visual assessment during drilling. Recoveries were not consistently quantified in the drill hole database, but were reported to have been satisfactory. In 2005 average estimated recoveries ranged from 87% to 94% in the main mineralised zones.</li> <li>Much of the mineralised material is extremely fine grained. Potential for biases due to loss of sample during RC drilling was recognised and investigated at several stages.</li> <li>In 2000, a statistical study of the relationship between subsample weights and Ni-Co grades concluded that any biases were unlikely to be large enough to have a material impact on resource grade estimates for Ni or Co. However, the study was clouded by</li> </ul>

Criteria	Commentary
	<p>unreliable weight data and a distinct negative correlation between bulk density and Ni-Co grades. It was noted that any apparent biases could have been artifacts of the data.</p> <ul style="list-style-type: none"> <li>Subsequently, in 2005, as a practical test a total of 20 close-spaced RC twins were drilled around 5 bulk sampled, large diameter Calweld holes (4 RC holes in each case, which were averaged). They yielded average Ni and Co grades that were extremely similar to average bulk sample grades:  Aggregated Calweld Bulk Samples 88.82 m 0.88% Ni 0.13% Co  Averaged &amp; Aggregated RC Twins 90.0 m 0.89% Ni 0.13% Co</li> <li>At the same time, 7 RC holes dating from 1998-2000 were also twinned with good results:  Aggregated Old RC Holes 156 m 0.74% Ni 0.12% Co  Aggregated 2005 RC Twins 156 m 0.75% Ni 0.12% Co</li> <li>The 2005 twinning programme indicated that RC samples were unlikely to have been affected by significant sampling biases.</li> </ul>
<i>Logging</i>	<ul style="list-style-type: none"> <li>All holes were geologically logged.</li> <li>Checking of stored RC cuttings in the field showed that some logging had been of dubious quality, but distinct geological changes were clearly reflected in multi-element sample assay results. Where contradictions occurred, analytical data were preferred as a guide to geological interpretations.</li> </ul>
<i>Sub-sampling techniques and sample preparation</i>	<ul style="list-style-type: none"> <li>No diamond core samples were used for resource grade estimation.</li> <li>RC holes were usually dry and field samples of approximately 2-4 kg were collected by riffing, consistent with common industry practice.</li> <li>Some damp or wet intervals were sampled by spear or grab sampling. These samples would not be reliable. The proportion of wet intervals was reported to have been very small, but they were not identified in the drill hole database, so they could not be quantified.</li> <li>Sample preparation at all the laboratories used reportedly involved pulverising the total received sample to nominal minus 75µm. In 2014-2015, if necessary, the received sample was riffle split to a maximum of 3 kg. Procedures were apparently similar at all stages and consistent with normal industry practices.</li> <li>Field duplicate samples were collected, normally at a rate of 1 per hole, approximating 1 in 25 to 1 in 35 samples. Results were located for 619 duplicates from the 1998-2000 period, 117 from 2005 and 105 from 2014-2015. On average, duplicate sample grades for Ni and Co compared closely with originals, indicating that sub-sampling procedures had been free of significant bias.</li> <li>In 2014-2015 field duplicates were reportedly collected by spear sampling bagged reject, but details could not be verified in the time frame of this estimate. If correct this would not be a satisfactory procedure, however it relates to only a small proportion of the assay data.</li> <li>In 2000, 204 duplicate samples from 5 RC holes were collected by independent consultants and submitted for independent assay. The results correlated well with those from the original samples. They also indicated that field sub-sampling procedures were</li> </ul>

Criteria	Commentary
	<p>free of significant bias.</p> <ul style="list-style-type: none"> <li>In 2005 another programme of independent duplicate sampling and assaying was conducted involving 149 samples from 4 RC holes, with similar good results.</li> <li>The mineralised material is predominantly fine to very fine grained. Sizing analysis of typical RC cuttings showed that on average approximately 60-75% by weight was minus 0.1mm. Sample sizes were appropriate.</li> </ul>
<p><i>Quality of assay data and laboratory tests</i></p>	<ul style="list-style-type: none"> <li>Prior to late 1998 samples were assayed at Australian Laboratory Services Pty Ltd (ALS), Orange, New South Wales, by AAS after perchloric acid digest of a 0.25 gm aliquot. Ni, Co &amp; Cr were routinely determined. Mn was determined for most samples and some Cu assays were reported. Selected samples were assayed for Mg, Ca &amp; Fe by ICPOES after aqua regia digest of a 0.25 gm aliquot. Pt was determined by 50gm fire assay with an AAS finish.</li> <li>From late 1998 to 2005 samples were assayed at Ultratrace Analytical Laboratories (Ultratrace), Canning Vale, Western Australia. Samples were routinely assayed for Ni, Co, Cr, Mn, Mg, Ca, Al, Fe, Sc, Zn, As and Cu by digestion of 0.3gm of sample pulp in a mixture of hot Hydrochloric, Nitric, Perchloric and Hydrofluoric acids, with an ICP_OES finish.</li> <li>In 2014-2015 samples were reportedly assayed at Australian Laboratory Services Pty Ltd (ALS), Brisbane, Queensland, after sample preparation at their Orange, New South Wales, facility. An aliquot of 0.25 gm was digested in a mixture of Perchloric, Nitric, Hydrofluoric and Hydrochloric acids, and analysed for Sc and 32 other elements, including Ni and Co, by Inductively Coupled Plasma – Atomic Emission Spectroscopy (ICP-AES).</li> <li>All assaying methods were appropriate for Ni, Co and Pt, and were regarded as total determinations.</li> <li>Between late 1998 and 2005 a small proportion of samples were assayed for Si by sodium peroxide fusion of a 0.3 gm sample with an ICPOES finish. The results were used to develop a regression equation to calculate Si values. The great majority of Si values in the drill hole database are calculated and can only be regarded as semi-quantitative. Si values had no direct influence on resource grade estimation.</li> <li>No analyses were obtained using Geophysical tools.</li> <li>Sampling and assaying quality controls routinely imposed during drilling programmes in 1998–2000 and in 2005 consisted of field duplicate samples, extensive check assaying at independent laboratories and submission of a range of certified standard samples.</li> <li>In 2014–2015, field duplicate samples were routinely collected, apparently by spear sampling. This procedure was unsatisfactory. No check assaying was done. Only a single standard sample was used, which was intended primarily for monitoring Sc results. Ni and Co grades of the standard were far too low to provide useful data.</li> <li>The 2014–2015 programmes only contributed some 8% of drill holes accepted for use in Ni-Co resource estimation.</li> <li>Duplicate sampling results indicated that sub-sampling procedures were unbiased at all stages.</li> <li>Duplicate sampling demonstrated that precision levels were satisfactory in 1998–2000 and in 2005. Data from 2014–2015 indicated poorer precision levels, but results were</li> </ul>

Criteria	Commentary
	<p>possibly distorted by an unsatisfactory duplicate sampling procedure.</p> <ul style="list-style-type: none"> <li>• Check assaying results prior to 1998, in 1998–2000 and in 2005 were consistently good and showed close agreement at all stages between the 3 reputable laboratories that were involved. Mean relative differences for Ni and Co were within +/- 2%.</li> <li>• On average, standard sample results for Ni and Co in 1998–2000 and 2005 were higher than the expected values. Two sets of certified standards were used.</li> <li>• One set consisted of 5 standards, prepared from Syerston material and inserted into sample batches at the laboratory in 1998–2000 and in 2005. On average results were about 3%–5% relative higher than the expected values for both Ni and Co, during both time periods.</li> <li>• Another set of 5 standards, prepared from material from other lateritic Ni-Co deposits, were inserted on site, blind to the laboratory, during 2005. They gave Ni and Co results averaging about 8% relative higher than the expected values.</li> <li>• The apparent biases shown by standard samples were of serious concern, but completely at odds with consistently good check assaying results.</li> <li>• An investigation into the standard samples in 2005 substantiated the laboratory results and failed to explain the differences from expected values. It was concluded that they were probably due to more effective digestion techniques at the 3 laboratories involved in check assaying programmes than at some of the other laboratories involved in establishing expected values for the standards. However, the possibility of some bias could not be entirely ruled out.</li> </ul>
<p><i>Verification of sampling and assaying</i></p>	<ul style="list-style-type: none"> <li>• Independent custody sampling programmes were conducted by two different groups of independent consultants in 2000 and 2005. They involved a total of 253 metres from 9 RC drill holes. Results verified the original intercepts.</li> <li>• Twin drilling in 2005 was discussed above.</li> <li>• Due to the age of much of the data and changes in project ownership, details of primary data entry procedures were largely obscure.</li> <li>• In 2000, independent consultants conducted validation checks against original sources for 66 holes. Some collar coordinates could not be validated because original records were not located. No significant errors were found in the assay data.</li> <li>• In 2005 a drill hole database created by the previous owner was subjected it to extensive tests for internal errors and inconsistencies. Very few problems were detected.</li> <li>• In 2005 validation checks were carried out on 100 holes.</li> <li>• Collar coordinates were checked against surveyors' reports and/or drill logs. No survey records could be located for the 16 aircore holes involved and some early RC holes. A total of 17 early, predominantly aircore holes showed significant coordinate discrepancies against drill logs that could not be resolved. Where original survey reports were available, all database coordinates were found to be correct. The quality of the survey database was open to doubt for holes drilled before about 1997. The great majority of holes accepted for use in resource estimation were drilled later.</li> <li>• Database assay records were checked against original laboratory reports for 1,673 pre-2005 samples and 908 samples from 2005 drilling. Only a single incorrect Si value was</li> </ul>

Criteria	Commentary
	<p>detected. The assay database seemed to be of good quality.</p> <ul style="list-style-type: none"> <li>No adjustments to laboratory assay data were required.</li> </ul>
<i>Location of data points</i>	<ul style="list-style-type: none"> <li>Collar survey procedures prior to 1998 were unclear.</li> <li>For drilling programmes between 1998 and 2000, collars were picked up by contract licensed surveyors.</li> <li>In 2005, collar positions were pegged out by contract licensed surveyors. Holes were collared within 0.1m of pegs or offsets were measured by steel tape to 0.1m.</li> <li>In 2014-2015 drill hole collars were reportedly located by hand-held GPS, but details could not be verified because the contractor involved was overseas and could not be contacted. This procedure would not normally be considered suitable for resource estimation purposes.</li> <li>Local project grid coordinates have been used throughout. A transformation between local grid and national coordinates (AGD84) was established by licensed surveyors around late 1998.</li> <li>A new national grid system has since been adopted (GDA94). Care is required to ensure that any national coordinates used in connection with the project are all in the same system.</li> <li>Local topographic survey control is adequate, based on a photogrammetric survey flown in 1999.</li> </ul>
<i>Data spacing and distribution</i>	<ul style="list-style-type: none"> <li>Most of the deposit area has been covered by vertical RC drilling on a 120m x 120m pattern. A substantial proportion of the more strongly mineralised areas have been covered by vertical RC drilling on a 60m x 60m pattern and some limited areas have been infilled to 30m x 30m. This is sufficient to establish geological and grade continuity appropriate for the resource estimation procedures used and resource classifications applied.</li> <li>For resource estimation purposes drill hole samples were composited over 2m down hole intervals to reflect block model parameters and likely open pit working bench heights.</li> </ul>
<i>Orientation of data in relation to geological structure</i>	<ul style="list-style-type: none"> <li>Vertical drill holes were appropriate for delineation of the broadly sub-horizontal laterite hosted Ni-Co mineralisation.</li> <li>However, in similar deposits, unusually high Co values are often associated with Mn concentrations in steeper relict structures and can therefore have very limited lateral continuity.</li> <li>30m infill drilling programmes conducted in early 2005 were intended to better constrain some of these high Co values. Combined with harsher top cutting of Co in areas of wider spaced drilling this risk has been ameliorated as a result. But it has not been eliminated.</li> </ul>
<i>Sample security</i>	<ul style="list-style-type: none"> <li>As far as could be determined, no specific security measures were imposed prior to 2005. However, independent custody sampling by consultants in 2000 indicated that tampering was unlikely to have occurred.</li> <li>In 2005, a system of security tags was used to prevent any tampering with bagged samples between the project site and the laboratory.</li> </ul>

Criteria	Commentary
	<ul style="list-style-type: none"> <li>Independent custody sampling 2005 confirmed that tampering was unlikely to have occurred.</li> <li>As far as could be determined, no specific security measures were imposed during 2014-2015.</li> </ul>
<i>Audits or reviews</i>	<ul style="list-style-type: none"> <li>Independent technical reviews by independent consultants SNC-Lavalin Australia Pty Ltd (SLA) in 2000 and by McDonald Speijers (MS) in 2005 concluded that data collection procedures since late 1998 had been generally satisfactory and consistent with normal industry practices.</li> </ul>

## Section 2 Reporting of Exploration Results

Criteria	Commentary
<i>Mineral tenement and land tenure status</i>	<ul style="list-style-type: none"> <li>The deposit is covered by Exploration Licence EL4573 held 100% by Scandium21 Pty Ltd. It was granted on 17th August 1993 and has an expiry date of 16th August 2018, which may be extended by future applications for renewal.</li> <li>Conditions that apply to the licence appear to be normal conditions that would apply to any similar tenement in New South Wales.</li> <li>The project was granted Development Consent under the NSW Environmental Protection and Assessment Act in May 2001. Scandium21 state that the consent remains in place.</li> <li>Five applications for Mining Leases have been lodged over the area of the deposit. These are also registered in the name of Scandium21 Pty Ltd. They remain pending.</li> <li>Scandium21 also holds title to a number of freehold farming properties in and around the area of the deposit.</li> <li>There appear to be no impediments to obtaining a licence to operate.</li> </ul>
<i>Exploration done by other parties</i>	<ul style="list-style-type: none"> <li>The deposit has been subjected to multiple drilling programmes by 5 different owners since 1988.</li> <li>About 97% of the drill hole data accepted for use in resource grade estimation dates from mid 1997 or later.</li> </ul>
<i>Geology</i>	<ul style="list-style-type: none"> <li>Syerston is an iron rich Ni laterite deposit with higher than normal levels of associated Co and local elevated Pt and Sc values. It has developed over an ultramafic, intrusive complex.</li> <li>The laterite profile is best developed over a dunite core and thins over peripheral pyroxenites.</li> <li>The laterite profile is partly overlain by transported alluvium.</li> <li>The laterite profile is interpreted to consist of 5 sub-horizontal zones: <ul style="list-style-type: none"> <li>Residual Overburden (OVB): Hematitic material below the base of any alluvium, but with Ni grade below about 0.2%</li> <li>Transitional Zone (TZ): Hematitic to goethitic material with an upper boundary defined by approximately 0.2% Ni, where values greater than this extend above</li> </ul> </li> </ul>

Criteria	Commentary
	<p>the top of the underlying Goethite Zone.</p> <ul style="list-style-type: none"> <li>Goethite Zone (GZ): Composed mainly of very fine grained goethite. Upper boundary defined by Mn greater than 0.35% with Fe usually greater than 33%, preferably greater than 43%.</li> <li>Silicified Goethite Zone (SGZ): Similar goethitic material to the GZ, but with veins, bands and mesh works of secondary silica. Upper boundary defined by approximately 15% Si.</li> <li>Saprolite Zone (SAP): Clay rich, intensely weathered bedrock. Upper boundary defined by about 6% Mg.</li> </ul> <ul style="list-style-type: none"> <li>Ni-Co mineralisation is best developed in the GZ and SGZ, overlying the dunite.</li> </ul>

### Section 3 Estimation and Reporting of Mineral Resources

Criteria	Commentary
<i>Database integrity</i>	<ul style="list-style-type: none"> <li>In 2000, SLA conducted detailed validation checks on 68 drill holes.</li> <li>In 2005 MS conducted validation checks on 100 holes, involving 1,673 samples from pre-2005 drilling programmes and 908 samples obtained in 2005.</li> <li>Where original survey reports could be located, collar surveys in the database were found to be correct. However, survey data for aircore holes and some RC holes dating from before late 1998-1999 could not be validated due to lack of records.</li> <li>Assays were comprehensively checked against original laboratory reports. No errors of any significance were detected.</li> <li>MS did not conduct validation checks on the very small proportion of additional drilling carried out in 2014-2015. MS were aware that checks had been conducted by other consultants.</li> </ul>
<i>Site visits</i>	<ul style="list-style-type: none"> <li>Site visits were made by MS personnel in November 2004 and February 2005 to review the geology and field procedures.</li> </ul>
<i>Geological interpretation</i>	<ul style="list-style-type: none"> <li>In 2005 MS made a conscious effort to seek alternatives to laterite zone interpretations made by others in 2000. In spite of this, interpretations resembled those previously made. Laterite zone interpretations seem to be reasonably robust, at least over the dunite, even though many boundaries are likely to be irregular and diffuse.</li> <li>Laterite zone interpretations were based on all existing drill holes in the data base.</li> <li>Site checks revealed that some geological coding in the data base was unreliable. Where analytical data conflicted with geological codes the analytical data were used to guide interpretations.</li> <li>Interpreted laterite zones were used to constrain resource grade estimation.</li> <li>There has been considerable lateral dispersion of Ni and Co in the laterite profile, but high Co values (above about 0.4-0.5%) tend to be closely associated with Mn and can have very limited lateral continuity. Infill and twin drilling programmes in 2005 confirmed this. They may be localised in relict, dipping structures.</li> </ul>

Criteria	Commentary
<i>Dimensions</i>	<ul style="list-style-type: none"> <li>The bulk of the Ni-Co resource occurs in an area measuring about 3,000 m north-south by 3,500 m east-west. The top of the main mineralised zones occurs at depths ranging from 0 m to about 25 m below surface and they are typically about 5 m to 25 m in thickness.</li> </ul>
<i>Estimation and modelling techniques</i>	<ul style="list-style-type: none"> <li>Resource estimation procedures were largely unchanged from 2005. The exception is scandium, which in 2016 was estimated separately as high-grade ‘pods’, generally peripheral to the nickel/cobalt mineralisation, and as background mineralisation that contributes only as accessory mineralisation to the nickel/cobalt resource.</li> <li>A 3-dimensional resource block model was generated using Datamine software. Block dimensions were 20 m x 20 m x 2 m vertical compared with typical drill hole spacings of 60-120 m.</li> <li>Block grades were estimated for Ni, Co, Pt, Fe, Si, Al, Ca, Cu, Cr, Mg, Mn, Sc and Zn.</li> <li>Estimates for Ni, Co, Pt, Fe, Si, Mg, Al and Mn were made by ordinary kriging. Other elements were estimated using an anisotropic inverse distance squared interpolation.</li> <li>Laterite zones were used to construct 3-dimensional surface wireframes that were used to flag model blocks and constrain grade interpolations. To reflect their probable gradational and irregular nature, controlled transparency of 2m vertically was allowed across the TZ/GZ, GZ/SGZ and SGZ/SAP boundaries during block grade estimation.</li> <li>Top cuts were applied to several elements by laterite zone. Top cuts for Co varied according to typical drill hole spacing to reduce the risk of serious local overestimation of average Co grade around unusually high values in widely spaced holes.  Top cuts for Ni and Co were:  TZ: Ni 1.5%; Co 0.15% GZ: Ni 2.5%; Co 1.0% (30 m pattern), 0.5% (60 m+ pattern) SGZ: Ni 2.25%; Co 0.35% (30 m pattern), 0.25% (60 m+ pattern) SAP: Ni 1.75%; Co 0.1%</li> <li>The proportions of samples affected by top cuts in the main mineralised zones ranged from approximately 0% to 0.1% for Ni, 0% to 1.25% for Co in areas of 30m infill drilling and 1% to 3% in areas of wider spaced drilling.</li> <li>Drill hole samples were composited to 2m for block grade estimation.</li> <li>Data search ellipsoids were based on either the first or second variogram structure depending on whether they were 2 or 3-component models. Horizontal variogram ranges were scaled so that a minimum horizontal search distance in any direction was 100m (the minimum required to find at least the nearest hole in all directions for the predominant 60 x 60 m drilling pattern). Horizontal anisotropy for Ni and Co was rarely more than 2:1. Data search distances were typically 100 to 300m horizontally and 6m vertically.</li> <li>The results obtained from the block model compared satisfactorily with previous</li> </ul>



Criteria	Commentary
	<p>estimates.</p> <ul style="list-style-type: none"> <li>• Cutoff grade and nickel equivalent factors were based on Ni and Co only. No account was taken of Pt due to low reliability of grade estimates and uncertainty about recoverability. None of the other elements estimated were taken into account or regarded as deleterious elements.</li> <li>• The model was extensively checked by visual comparison of block grades with composite grades. In addition, average block grades and average composite grades were calculated and compared for sets of 60m sectional slices through the model. Comparisons were satisfactory.</li> </ul>
<i>Moisture</i>	<ul style="list-style-type: none"> <li>• All reported tonnage figures are in dry tonnes obtained by applying dry bulk density factors.</li> </ul>
<i>Cut-off parameters</i>	<ul style="list-style-type: none"> <li>• Using metallurgical, price and cost assumptions specified by the client and based on previous feasibility studies, a mill feed breakeven cutoff grade was estimated to be 0.60% Ni equivalent (NIEQ), based on a formula of:   <math display="block">\text{NIEQ}\% = \text{Ni}\% + (\text{Co}\% * 2.95)</math> </li> <li>• Assumed metal prices were US\$4.00/lb Ni and US\$12/lb Co, with a USD:AUD exchange rate of 0.70.</li> <li>• Average overall metallurgical recoveries to final product were estimated to be 90.0% for Ni and 88.9% for Co.</li> </ul>
<i>Mining factors or assumptions</i>	<ul style="list-style-type: none"> <li>• The deposit is amenable to conventional open pit mining. Two feasibility studies have developed practicable staged open pit mine plans based on conventional open pit mining by contractor, using large backhoes and trucks, operating on working benches 2m in height. The most recent study assumed about 2.5 Mtpa of feed to a processing plant.</li> </ul>
<i>Metallurgical factors or assumptions</i>	<ul style="list-style-type: none"> <li>• A substantial amount of metallurgical test work has been undertaken as part of the feasibility studies conducted in 2000 and 2005.</li> <li>• Sufficient work has been done to demonstrate that a potentially viable treatment process is available for the Syerston lateritic Ni-Co mineralisation. The proposed process involves high pressure acid leaching followed by decantation of pregnant liquor by counter current decantation, neutralisation and mixed sulphide precipitation.</li> <li>• There do not appear to be any metallurgical factors that might preclude the deposit from being reported as an identified Mineral Resource.</li> </ul>
<i>Environmental factors or assumptions</i>	<ul style="list-style-type: none"> <li>• The area in which the Ni-Co resource occurs does not seem to have any unusual environmental significance.</li> <li>• An Environmental Impact Statement (EIS) was prepared in parallel with the 2000 feasibility study and in May 2001 the proposed Ni-Co project received Development Consent under the NSW Environmental Planning and Assessment Act.</li> </ul>

Criteria	Commentary
	<ul style="list-style-type: none"> <li>• Despite the fact that additional permits and licences would have to be obtained before operations could commence, previous granting of a Development Consent indicates that there are unlikely to be any insurmountable environmental obstacles.</li> <li>• There are no obvious environmental factors that would prevent the deposit being reported as an identified mineral resource.</li> </ul>
<i>Bulk density</i>	<ul style="list-style-type: none"> <li>• Dry bulk density factors used for a resource estimate in 2000 were accepted without change for the 2005 resource model and for this update. No additional measurements were available and there did not seem to be any justification for changes.</li> <li>• The measurements available were limited in number. Additional measurements should be obtained at any opportunity.</li> <li>• The factors used were based primarily on measurements obtained by weighing total material recovered from over 100 m of drilling in mineralised zones by 6 large diameter Calweld holes, adjusted for moisture content determined by oven drying quickly sealed grab samples. As documented, the procedures used seemed appropriate. Due to the relatively large volumes involved these should have been the most reliable measurements available.</li> <li>• Measurements made after drying small core samples from 5 diamond drill holes were given some influence.</li> <li>• Factors applied to the more mineralised zones tended to be slightly rounded downwards. This was prudent in view of the general tendency for a negative correlation between bulk density and grade.</li> <li>• A higher average value was assumed for the SGZ than indicated by the Calweld holes. This was reasonable because they failed to fully penetrate the zone and we would expect average density to increase in its lowermost parts.</li> </ul>
<i>Classification</i>	<ul style="list-style-type: none"> <li>• The resource model was independently classified mainly on the basis of: <ul style="list-style-type: none"> <li>• An assessment of overall sampling and assaying reliability, and of levels of confidence in the continuity, geometry and probable boundary characteristics of the main mineralised zones provided by various drill hole patterns.</li> <li>• A 2005 review of average kriging variances, kriging efficiencies and kriging slopes of regression for Ni and Co block grade estimates in the 2 main mineralised zones (GZ &amp; SGZ).</li> <li>• The result was a classification primarily reflecting drilling patterns: <ul style="list-style-type: none"> <li>Measured: Consistent 60m x 60m pattern or closer</li> <li>Indicated: Consistent 120m x 120m pattern or closer</li> <li>Inferred: Other areas within the overall model boundary</li> </ul> </li> </ul> </li> <li>• The result reflected the Competent Person's views.</li> </ul>
<i>Audits or</i>	<ul style="list-style-type: none"> <li>• This resource estimate has not been subject to any independent, external audits or</li> </ul>

Criteria	Commentary
<i>reviews</i>	reviews.
<i>Discussion of relative accuracy/confidence</i>	<p>The principal factors that may contribute to resource estimation errors are:</p> <ul style="list-style-type: none"> <li>• Poor lateral continuity of unusually high Co grades (say above about 0.4% to 0.5%). These could be associated with Mn concentrations in inclined, relict structures which might be poorly represented in vertical drill holes. Local Infill drilling to 30m x 30m and harsher Co top cuts in areas of wider-spaced drilling have ameliorated this risk, but it has not been eliminated.</li> <li>• Incorrect geological interpretation. Sometimes a major source of error, but in this case interpretations seem to be reasonably robust.</li> <li>• Error in the interpreted lateral limits of mineralisation, related to drill hole spacings.</li> <li>• The nature of mineralisation boundaries, which are likely to be gradational and possibly very irregular.</li> <li>• Sampling and assaying errors, particularly any biases. Twin drilling indicated that serious bias in RC samples is unlikely, but the existence of some biases cannot be categorically ruled out.</li> <li>• Inherent estimation error arising from the fact that samples represent only a minute proportion of the deposit as a whole.</li> <li>• Bulk density factors based on limited numbers of direct measurements.</li> <li>• The highest risk is associated with estimated Co metal content.</li> </ul>

**Table 4: List of Drill Holes Accepted for Use in Resource Estimation**

BHID	Easting	Northing	RL	Hole Type	Depth
SAC127	11815.46	21868.44	295.05	AIRCORE	29
SAC128	11674.56	21153.85	284.69	AIRCORE	30
SAC131	10688.22	22895.03	314	AIRCORE	30
SAC132	10587.57	22895.03	315	AIRCORE	28
SAC133	10768.74	22895.03	313	AIRCORE	26
SAC134	10829.13	22895.03	315	AIRCORE	24
SAC135	10708.35	22955.42	316	AIRCORE	24
SAC136	10708.35	22834.64	311	AIRCORE	33
SAC137	10708.35	22774.26	308	AIRCORE	30
SAC138	10647.96	22774.26	308	AIRCORE	32
SAC139	10587.57	22774.26	309	AIRCORE	30
SAC144	13364.95	20362.09	284.04	AIRCORE	40
SAC148	12879.52	20363.42	285.11	AIRCORE	44
SAC151	13496.49	20242.61	283.87	AIRCORE	32
SAC152	13503.28	20186.17	284.47	AIRCORE	39
SAC153	13364.62	20167.79	285.61	AIRCORE	33
SAC154	13236.61	20115.75	286.15	AIRCORE	38
SAC168	12284.22	20126.93	291.23	AIRCORE	42
SAC184	12286.21	20005.23	293.95	AIRCORE	36
SAC200	11310.89	21676.81	289.69	AIRCORE	37
SAC201	11312.73	21559.6	287.77	AIRCORE	39
SAC206	11064.86	21804.39	290.76	AIRCORE	31
SAC212	11433.56	21803.54	293.35	AIRCORE	30
SAC213	11436.1	21563.02	287.59	AIRCORE	39
SAC214	11440.81	21439.95	286.06	AIRCORE	30
SAC220	11449.09	21312.2	285.23	AIRCORE	25
SAC222	11422.9	21206.98	286.6	AIRCORE	27
SAC227	10800.42	21186.02	287.61	AIRCORE	27
SAC231	11563.55	21431.09	285.21	AIRCORE	30
SAC233	12020.62	21437.51	285.5	AIRCORE	28
SAC234	12297.31	21438.55	285.04	AIRCORE	27
SAC235	12312.17	21338.97	283.43	AIRCORE	25
SAC236	12298.69	21566.55	289.24	AIRCORE	28
SAC237	12416.42	21558.43	287.82	AIRCORE	30
SAC240	12654.2	21075.48	281.92	AIRCORE	38
SAC241	12530.5	21199.95	281.38	AIRCORE	28
SAC242	12310.41	21207.91	283.37	AIRCORE	34
SAC243	12162.42	21309.64	282.43	AIRCORE	36
SAC249	11683.01	21083.45	286.08	AIRCORE	39
SAC251	11916.43	21088.52	285.9	AIRCORE	42
SAC256	12509.85	21095.65	282.95	AIRCORE	27
SAC258	12147.72	21218.29	282.83	AIRCORE	22
SAC264	10843.68	20958.99	289.82	AIRCORE	34
SAC265	11070.55	20961.4	287.85	AIRCORE	32
SAC267	13638.87	20570.64	281.48	AIRCORE	36
SRC0001	11674.24	22410.17	309.7	RC	30
SRC0002	11674.43	22291.11	308.9	RC	24
SRC0003	11674.27	22171.17	304.42	RC	38
SRC0004	11553.92	22341.28	310.75	RC	24
SRC0005	11554	22220.7	304.74	RC	30
SRC0006	11553.45	22100.22	301.63	RC	44
SRC0007	11433.47	22230.67	303.25	RC	42
SRC0008	11432.99	22350.89	305.73	RC	30
SRC0009	11795.44	22231.62	303.71	RC	34
SRC0010	11795.21	22110.54	300.46	RC	36
SRC0011	11795.14	21988.72	297.1	RC	34
SRC0012	11675.27	22049.98	300.73	RC	44
SRC0013	11910.75	22043.38	300.57	RC	26
SRC0014	12158.04	22089.45	293.74	RC	18
SRC0015	12037.64	22049.6	297.31	RC	34
SRC0016	12036.52	21928.85	299.57	RC	30
SRC0017	12035.6	21807.54	299.15	RC	48
SRC0018	12523.14	21748.94	296.68	RC	43
SRC0019	12519.93	21629.81	292.34	RC	38

BHID	Easting	Northing	RL	Hole Type	Depth
SRC0020	12639.39	21544.42	288.06	RC	34
SRC0021	12523.81	21536.93	288.49	RC	31
SRC0022	12760.91	21445.67	282.64	RC	24
SRC0023	11914.38	21806.67	297.28	RC	43
SRC0024	11790.81	21749.86	292.23	RC	46
SRC0025	11675.81	21553.3	287.29	RC	43
SRC0026	11549.87	21497.81	286.08	RC	43
SRC0027	11439.25	21372.55	285.58	RC	48
SRC0028	11312.66	21254.79	285.76	RC	48
SRC0029	11310.32	21144.52	285.38	RC	46
SRC0030	11552.87	21084.06	285.83	RC	48
SRC0031	11559.51	21327.03	284.73	RC	48
SRC0032	11554.85	21202.95	285	RC	48
SRC0033	11672.8	21293.52	284.06	RC	48
SRC0034	11787.56	21629.58	288.76	RC	48
SRC0035	11913.61	21688.85	292.12	RC	52
SRC0036	11911.06	21568.64	287.99	RC	49
SRC0037	12020.65	21580.15	289.7	RC	49
SRC0038	11911.44	21441.9	284.6	RC	46
SRC0039	11785.61	21386.92	283.76	RC	48
SRC0040	11782.48	21506.29	285.82	RC	48
SRC0041	11431.8	21058.86	285.54	RC	64
SRC0042	11781.7	21209.1	283.81	RC	54
SRC0043	11779.71	21266.1	284.87	RC	55
SRC0044	11903	21320.03	283.16	RC	46
SRC0045	12036.29	21265.55	282.9	RC	40
SRC0046	12517.6	21149.6	281.87	RC	52
SRC0047	12767.69	21093.58	280.16	RC	52
SRC0048	12879.89	21080.58	279.6	RC	52
SRC0049	12761.47	21324.62	280.74	RC	48
SRC0050	12760.6	21211.08	280.04	RC	52
SRC0051	12520.13	21277.15	280.92	RC	48
SRC0052	12638.97	21423.47	284.85	RC	25
SRC0052A	12637.82	21421.83	284.85	RC	48
SRC0053	12517.17	21400.98	284.1	RC	48
SRC0054	12414.38	21323.79	280.27	RC	46
SRC0055	12155.35	21556.52	288.64	RC	52
SRC0056	12153.91	21678.68	292.79	RC	46
SRC0057	12034.75	21696.07	295.22	RC	52
SRC0058	13003.12	21324.91	279.77	RC	10
SRC0059	12882.37	21325.15	280.32	RC	30
SRC0060	12399.45	21691.88	293.06	RC	55
SRC0061	12278.81	21687.35	294.84	RC	55
SRC0062	12158.38	21807.91	296.15	RC	25
SRC0063	12278.82	21807.73	294.45	RC	19
SRC0064	12398.05	21808.54	293.83	RC	60
SRC0065	12296.94	21948.1	292.49	RC	31
SRC0066	12761.7	20962.19	283.22	RC	56
SRC0067	12639.52	20964.13	284.52	RC	52
SRC0068	12521.47	20962.62	284.76	RC	52
SRC0069	12278.72	20963.41	286.54	RC	52
SRC0070	12156.49	21032.51	286.61	RC	52
SRC0071	11553.99	20962.86	288.63	RC	61
SRC0072	11674.55	20842.16	289.31	RC	58
SRC0073	11787.05	20963.28	287.97	RC	55
SRC0074	11795.16	21082.46	286.16	RC	54
SRC0075	11915.17	21203.04	283.73	RC	52
SRC0076	12030	21139.35	284.87	RC	52
SRC0077	11912.46	21034.76	286.6	RC	58
SRC0078	12037.34	20962.25	287.83	RC	54
SRC0079	12640.76	20842.83	285.56	RC	60
SRC0080	12635.26	19820.25	298.33	RC	50
SRC0081	12639.68	19745.3	299.85	RC	56
SRC0082	12520.21	19835.37	297.59	RC	56
SRC0083	12404.08	20190.46	290.01	RC	56
SRC0084	12399.53	20328.7	288.45	RC	52
SRC0085	12519.66	20358.4	287.29	RC	55
SRC0086	12519.52	20479.36	286.11	RC	58
SRC0087	12763.18	20840.38	284.75	RC	58

BHID	Easting	Northing	RL	Hole Type	Depth
SRC0088	12881.93	20839.16	283.83	RC	58
SRC0089	13002.78	20841.5	282.94	RC	60
SRC0090	13124.33	20841.32	281.58	RC	61
SRC0091	13245.48	20842.07	280.26	RC	61
SRC0092	13005.34	21083.08	279.53	RC	55
SRC0093	13246.6	20716.49	280.39	RC	64
SRC0094	13013.1	20715.22	281.66	RC	60
SRC0095	12760.31	20599.24	283.65	RC	37
SRC0096	12871.68	20600.19	282.95	RC	49
SRC0097	13003.29	20600.07	282.09	RC	49
SRC0098	13123.11	20599.82	281.74	RC	49
SRC0099	13244.31	20599.65	282.17	RC	55
SRC0100	13352.1	20673.64	281.33	RC	55
SRC0102	13003.23	20480.72	283.31	RC	49
SRC0103	12874.91	20480.14	283.91	RC	49
SRC0104	12761.61	20478.94	284.7	RC	49
SRC0105	12767.33	20355.45	286.09	RC	49
SRC0106	12880.64	20237.88	286.38	RC	49
SRC0107	13123.65	20297.01	284.63	RC	43
SRC0108	13245.31	20302.63	285.17	RC	55
SRC0109	13365.2	20569.24	283.04	RC	55
SRC0110	13467.63	20434.22	282.88	RC	49
SRC0111	12881.59	20355.88	289.35	RC	45
SRC0112	12761.37	20059.21	290.68	RC	49
SRC0113	12520.14	20057.67	292.08	RC	49
SRC0114	12399.44	20078.18	291.89	RC	49
SRC0115	12156.57	19996.71	294.4	RC	49
SRC0116	12141.83	19887.14	297.56	RC	48
SRC0117	12278.39	19875.56	298.78	RC	49
SRC0118	12399.77	19954.24	294.53	RC	40
SRC0119	12397.59	19836.99	297.13	RC	26
SRC0120	12761.14	19875.48	295.45	RC	30
SRC0121	12882.37	19876.65	292.33	RC	42
SRC0122	10831.62	21808.39	294.4	RC	31
SRC0123	10950.48	21808.42	291.05	RC	42
SRC0124	10834.64	21691.14	298.38	RC	34
SRC0125	10948.95	21564.51	296.14	RC	41
SRC0126	11081.23	21436.16	293.51	RC	43
SRC0127	11070.53	21616.55	291.16	RC	43
SRC0128	11072.82	21734.37	289.86	RC	39
SRC0129	11074.24	21928.95	293.46	RC	45
SRC0130	11073.37	22048.72	295.61	RC	37
SRC0131	11195.45	22108.94	298.23	RC	39
SRC0132	11196.73	21988.43	296.2	RC	43
SRC0133	11195.94	21866.74	292.87	RC	49
SRC0134	11194.43	21747.13	290.1	RC	49
SRC0135	11193.87	21626.24	288.75	RC	46
SRC0136	11193.55	21505.47	288.61	RC	42
SRC0137	11196.87	21355.14	287.41	RC	43
SRC0138	11053.37	21199.55	286.32	RC	31
SRC0139	11079.35	21327.71	289.55	RC	43
SRC0140	10948.98	21423.7	292.01	RC	40
SRC0141	10953.83	21312.62	291.13	RC	37
SRC0142	10822.3	21447.21	294.18	RC	30
SRC0143	10824.68	21575.22	297.29	RC	37
SRC0144	10717.24	21675.56	294.34	RC	19
SRC0145	10704	21568.8	293.24	RC	25
SRC0146	10599.64	21434.66	289.87	RC	13
SRC0147	10580.48	21341.79	288.77	RC	7
SRC0148	10700.29	21341.97	288.67	RC	30
SRC0149	10813.75	21342.47	291.24	RC	31
SRC0150	11310.2	21370.62	286.42	RC	43
SRC0151	11311.87	21494.8	287.14	RC	43
SRC0152	11311.74	21614.49	288.5	RC	43

BHID	Easting	Northing	RL	Hole Type	Depth
SRC0153	11312.7	21736.55	290.88	RC	43
SRC0154	11312.04	21856.58	293.73	RC	43
SRC0155	11311.81	21976.82	297.64	RC	43
SRC0156	11312.85	22096.29	301.05	RC	43
SRC0157	11301.02	22201.41	300.88	RC	37
SRC0158	11430.5	22105.19	301.1	RC	43
SRC0159	11434.13	21992.21	297.73	RC	49
SRC0160	11433.19	21868.34	294.91	RC	49
SRC0161	11433.25	21747.9	292.05	RC	49
SRC0162	11433.8	21631.11	289.1	RC	43
SRC0163	11440.49	21517.78	286.75	RC	43
SRC0164	11553.98	21611.05	288.29	RC	37
SRC0165	11554.34	21737.28	291.54	RC	43
SRC0166	11554.38	21857.03	295.75	RC	43
SRC0167	11557.92	21992.35	299.59	RC	43
SRC0168	11676.19	21806.61	292.9	RC	43
SRC0169	11192.36	21084.99	285.97	RC	37
SRC0170	10948.31	21086.11	287.6	RC	43
SRC0171	10704.99	21079.1	289.66	RC	31
SRC0172	10586.51	21204.49	289.37	RC	25
SRC0173	10831.5	20848.06	290.48	RC	43
SRC0174	10948.96	20841.38	289.88	RC	43
SRC0175	11069.75	20840.45	287.39	RC	40
SRC0176	11073.3	20719.17	287.64	RC	43
SRC0177	11199.47	20845.61	286.78	RC	43
SRC0178	11300.66	20969.98	286.01	RC	43
SRC0179	10708.52	20842.72	291.68	RC	37
SRC0180	10832.45	20719.89	290.18	RC	43
SRC0181	10829.42	20600.31	289.45	RC	43
SRC0182	10948.63	20597.34	288.49	RC	43
SRC0183	11074.66	20586.78	288.55	RC	43
SRC0184	11194.46	20432.1	292.2	RC	43
SRC0185	11071.54	20480.16	290.32	RC	43
SRC0186	10950.72	20479.47	289.08	RC	43
SRC0187	10828.83	20478.59	289.19	RC	43
SRC0188	10949.63	20358.75	291.12	RC	37
SRC0189	11072.53	20359.11	292.11	RC	37
SRC0190	11312.07	20358.54	292.78	RC	43
SRC0191	11429.25	20354.88	292.09	RC	40
SRC0192	11311.36	20237.19	292.9	RC	37
SRC0193	11191.6	20307.81	292.97	RC	37
SRC0194	11072.2	20240.48	293.37	RC	31
SRC0195	11182.89	20181.91	293.34	RC	30
SRC0196	11554.85	20237.91	290.51	RC	37
SRC0197	11554.42	20118.43	290.39	RC	40
SRC0198	11313.91	20841.44	286.98	RC	46
SRC0199	11432.82	20841.19	288.79	RC	42
SRC0200	11556.99	20841.12	289.59	RC	44
SRC0201	11794.73	20841.77	288.87	RC	43
SRC0202	11917.1	20843.1	288.24	RC	49
SRC0203	12037.33	20841.49	288.41	RC	37
SRC0204	12158.64	20841.7	288.15	RC	40
SRC0205	12278.79	20841.46	287.56	RC	31
SRC0206	12399.07	20841.29	286.68	RC	37
SRC0207	12520.17	20842.33	286.11	RC	43
SRC0208	12519.76	20720.43	285.78	RC	46
SRC0209	12277.55	20721.32	287.59	RC	46
SRC0210	12158.2	20720.99	288.1	RC	43
SRC0211	12038.43	20721.58	288.58	RC	37
SRC0212	11795.28	20720.86	289.23	RC	42
SRC0213	11674.59	20721.3	289.91	RC	43
SRC0214	11553.45	20720.75	290.29	RC	43
SRC0215	11311.56	20721.05	288.44	RC	40
SRC0216	11192.14	20640.96	288.61	RC	40

**Clean TeQ Holdings Limited**  
 ABN 34 127 457 916

Ferntree Business Park  
 12/21 Howleys Rd, Notting Hill VIC Australia 3168  
 PO Box 227, Mulgrave VIC 3170 Australia  
 T: +61 3 9797 6700 F: +61 3 9706 8344  
 W: [www.cleanteq.com](http://www.cleanteq.com) E: [Info@cleanteq.com](mailto:Info@cleanteq.com)

BHID	Easting	Northing	RL	Hole Type	Depth
SRC0217	11311.78	20600.69	290.09	RC	43
SRC0218	11432.77	20603.17	290.86	RC	43
SRC0219	11553.49	20600.3	291.01	RC	40
SRC0220	11673.8	20600.58	290.3	RC	40
SRC0221	11794.85	20599.73	289.37	RC	46
SRC0222	11915.34	20600.06	288.3	RC	43
SRC0223	12037.21	20600.45	287.62	RC	37
SRC0224	12156.35	20601.04	287.09	RC	40
SRC0225	12277.88	20600.42	286.02	RC	43
SRC0226	12399.8	20599.77	285.72	RC	40
SRC0227	12519.54	20599.34	284.92	RC	49
SRC0228	12398.6	20479.8	286.51	RC	43
SRC0229	12276.78	20479.98	286.89	RC	43
SRC0230	12035.21	20491.63	287.49	RC	43
SRC0231	11795.22	20480.27	288.94	RC	43
SRC0232	11552.91	20479.56	291.25	RC	43
SRC0233	11432.69	20479.79	291.73	RC	43
SRC0234	11554.81	20358.78	291.1	RC	43
SRC0235	11674.79	20358.58	289.64	RC	43
SRC0236	11793.15	20347.86	288.89	RC	37
SRC0237	11915.97	20360.62	288.53	RC	43
SRC0238	12048.47	20345.63	288.63	RC	43
SRC0239	12158.04	20358.56	288.64	RC	43
SRC0240	12278.28	20359.63	288.49	RC	43
SRC0241	12257.7	20268.88	289.6	RC	43
SRC0242	12034.21	20250.4	289.79	RC	43
SRC0243	11795.38	20243.02	289.79	RC	37
SRC0244	11674.11	20238.78	289.68	RC	43
SRC0245	11917.51	20114.09	291.76	RC	43
SRC0246	12036.86	20115.73	291.62	RC	43
SRC0247	12152.72	20114.11	291.66	RC	37
SRC0248	12036.21	19996.86	293.44	RC	43
SRC0249	11792.38	20138.09	292.02	RC	37
SRC0250	11677.32	20119.12	290.38	RC	31
SRC0252	12014.17	19882.74	295.51	RC	43
SRC0253	11896.74	19860.02	296.5	RC	37
SRC0254	11792.33	19875.18	294.82	RC	37
SRC0255	11668.55	19992.37	291.4	RC	31
SRC0256	11554.42	20011.83	290.75	RC	37
SRC0257	11666.69	19876.47	292.14	RC	37
SRC0258	11680.42	19757.03	292.38	RC	31
SRC0259	11799.18	19754.47	294.19	RC	31
SRC0260	11906.16	19768.69	296	RC	25
SRC0261	11907.46	19630.61	295.06	RC	25
SRC0262	11320.24	22335.66	303.8	RC	31
SRC0263	12775.94	19395.54	287.85	RC	25
SRC0264	12670.37	19393.76	288.85	RC	25
SRC0265	12537.15	19521.56	293.73	RC	25
SRC0266	12396.76	19512.34	294.15	RC	25
SRC0267	12174.17	19583.78	295.71	RC	31
SRC0268	12036.66	19624.96	296.05	RC	37
SRC0269	12040.52	19744.83	299.28	RC	43
SRC0270	12270.12	19762.12	302.45	RC	43
SRC0271	12274.95	19642.2	297.65	RC	19
SRC0272	12390.8	19633.6	297.63	RC	7
SRC0273	12514.95	19609.16	298.01	RC	31
SRC0274	12777.63	19514.98	290.86	RC	43
SRC0275	12646.19	19630.93	299.4	RC	24
SRC0276	12762.25	19657.19	295.37	RC	30
SRC0277	12881.64	19634.27	296.14	RC	37
SRC0278	12888.3	19513.95	290.43	RC	31
SRC0279	13017.69	19493.19	285.63	RC	31
SRC0280	13121.35	19485.56	284.98	RC	25
SRC0281	13040.23	19633.46	289.18	RC	37

BHID	Easting	Northing	RL	Hole Type	Depth
SRC0282	13121.26	19629.34	287.01	RC	37
SRC0283	13611.18	19597.27	285.52	RC	37
SRC0284	13507.09	19585.99	285.6	RC	19
SRC0285	13346.38	19590.48	287.21	RC	31
SRC0286	13229.6	19637.03	287.4	RC	37
SRC0287	13244.15	19752.12	287.03	RC	37
SRC0288	13363.63	19754.35	287.18	RC	37
SRC0289	13411.16	19754.22	286.29	RC	31
SRC0290	13486.07	19872.73	287.66	RC	37
SRC0291	13601.65	19872.53	288.26	RC	37
SRC0292	13670.69	19847.24	289.72	RC	37
SRC0293	13803.1	19805.89	284.37	RC	37
SRC0294	13968.72	19756.9	284.84	RC	37
SRC0295	14101.22	19864.88	282.69	RC	37
SRC0296	14071.61	20429.97	280.47	RC	43
SRC0297	14039.13	20567.46	281.06	RC	43
SRC0298	13907.13	20426.84	282.47	RC	37
SRC0299	13988.95	20481.36	281.02	RC	37
SRC0300	14097.1	20357.4	280.62	RC	49
SRC0301	14156.97	20066.18	283.38	RC	43
SRC0302	13862.26	19885.64	285.36	RC	43
SRC0303	13795.08	19983.99	284.58	RC	43
SRC0304	13713.46	20110.92	282.03	RC	43
SRC0305	13659.2	20206.44	283.89	RC	43
SRC0306	13333.84	20121.46	286.29	RC	43
SRC0307	13527.37	20187.86	284.4	RC	43
SRC0308	13604.96	20117.26	285.27	RC	43
SRC0309	13702.82	20014.97	286.65	RC	43
SRC0310	13608.66	19996.93	288.31	RC	43
SRC0311	13477.57	19996.24	286.04	RC	37
SRC0312	13361.52	19996.46	286.77	RC	43
SRC0313	13249.81	19995.47	287.19	RC	37
SRC0314	13122.94	19998.95	287.94	RC	37
SRC0315	13009.06	20020.86	288.42	RC	38
SRC0316	13032.43	19929.01	285.52	RC	37
SRC0317	13122.35	19874.72	287.49	RC	43
SRC0318	13241.56	19874.83	285.4	RC	37
SRC0319	13366.17	19874.03	286.17	RC	37
SRC0320	13136.84	19724.01	288.02	RC	37
SRC0321	13117.94	21333.19	279.23	RC	37
SRC0322	13125.97	21096.92	279.16	RC	43
SRC0323	13126.65	21198.37	278.57	RC	43
SRC0324	13241.11	21202.58	277.97	RC	43
SRC0325	13251.37	20966.62	280.13	RC	43
SRC0326	13264.7	21081.52	278.39	RC	43
SRC0327	13361.86	21084.33	278.04	RC	43
SRC0328	13761.71	20725.85	281.6	RC	43
SRC0329	13624.51	20797.55	279.91	RC	49
SRC0330	13473.32	20842.4	279.06	RC	43
SRC0331	13484.52	20913.73	278.34	RC	43
SRC0332	13390.41	20825.93	279.19	RC	49
SRC0333	13452.97	20681.12	281.79	RC	43
SRC0334	13505.4	20590.88	281.92	RC	43
SRC0335	13592.33	20572.15	281.39	RC	40
SRC0336	13611.11	20353.53	282.96	RC	37
SRC0337	13599.63	20472.06	281.91	RC	40
SRC0338	13758.93	20463.16	283.07	RC	43
SRC0339	13855.37	20595.82	282.33	RC	43
SRC0340	13847.85	20836.74	280.02	RC	37
SRC0341	13300.5	20540.61	283.52	RC	40
SRC0342	13291.25	20549.9	283.35	RC	40
SRC0343	13282.89	20558.27	283.25	RC	40
SRC0344	13274.44	20566.89	283.1	RC	52
SRC0345	13265.97	20575.25	282.91	RC	40

Clean TeQ Holdings Limited  
 ABN 34 127 457 916

Ferntree Business Park  
 12/21 Howleys Rd, Notting Hill VIC Australia 3168  
 PO Box 227, Mulgrave VIC 3170 Australia  
 T: +61 3 9797 6700 F: +61 3 9706 8344  
 W: [www.cleanteq.com](http://www.cleanteq.com) E: [Info@cleanteq.com](mailto:Info@cleanteq.com)

BHID	Easting	Northing	RL	Hole Type	Depth
SRC0346	13257.51	20583.71	282.62	RC	40
SRC0347	13248.94	20592.24	282.36	RC	60
SRC0348	13240.76	20600.52	282.19	RC	52
SRC0349	13255.76	20600.55	282.32	RC	50
SRC0350	13270.88	20600.63	282.45	RC	50
SRC0351	13285.8	20600.54	282.57	RC	50
SRC0352	13300.68	20600.53	282.64	RC	46
SRC0353	13315.81	20600.57	282.73	RC	50
SRC0354	13330.78	20600.6	282.73	RC	46
SRC0355	13345.77	20600.64	282.7	RC	46
SRC0356	13360.29	20600.49	282.63	RC	46
SRC0357	13351.35	20592.03	282.81	RC	50
SRC0358	13342.92	20583.6	282.87	RC	46
SRC0359	13334.25	20574.9	283.11	RC	46
SRC0360	13325.94	20566.63	283.22	RC	50
SRC0361	13317.39	20558.14	283.27	RC	46
SRC0362	13308.94	20549.64	283.43	RC	46
SRC0363	13300.59	20555.77	283.32	RC	46
SRC0364	13300.55	20570.71	283.19	RC	46
SRC0365	13300.71	20585.79	283.04	RC	50
SRC0366	13270.3	20510.59	283.59	RC	46
SRC0367	13240.52	20480.62	283.79	RC	40
SRC0368	13300.68	20480.72	283.96	RC	40
SRC0369	13360.64	20481.17	283.8	RC	37
SRC0370	13330.69	20510.58	283.72	RC	36
SRC0371	13360.92	20540.17	283.38	RC	43
SRC0372	13240.51	20540.43	283.02	RC	46
SRC0373	13960.23	20000.12	286.21	RC	30
SRC0374	13480.27	20120.48	283.9	RC	36
SRC0375	13420.19	20060.57	285.75	RC	40
SRC0376	13300.24	19940.69	286.92	RC	36
SRC0377	13179.81	19819.94	287.11	RC	43
SRC0378	13658.6	20180.75	283.85	RC	39
SRC0379	13540.54	20060.46	286.66	RC	42
SRC0380	13420.47	19940.61	287.76	RC	31
SRC0381	13300.7	19821.07	286.21	RC	39
SRC0382	13180.12	19700.18	287.51	RC	36
SRC0383	13660.53	20060.47	285.8	RC	45
SRC0384	13540.49	19940.43	288.66	RC	46
SRC0385	13480.97	20360.64	283.16	RC	44
SRC0386	13242.77	20363.72	284.71	RC	45
SRC0387	12990.77	20364.06	284.41	RC	40
SRC0388	13180.36	20420.37	284.23	RC	33
SRC0389	13060.09	20300.54	284.76	RC	38
SRC0390	13420.29	19820.61	288.41	RC	30
SRC0391	13299.76	19699.68	289.5	RC	26
SRC0392	13360.01	19639.75	291.56	RC	21
SRC0393	13420.32	19700.79	287.4	RC	20
SRC0394	13508.86	19841.38	286.3	RC	40
SRC0395	13480.5	19760.32	279.51	RC	16
SRC0396	13652.79	19813.44	294.44	RC	32
SRC0397	13721.18	19880.63	287.61	RC	30
SRC0398	13780.56	19940.78	286.95	RC	50
SRC0399	13659.75	19939.9	288.51	RC	36
SRC0400	13900.57	19820.46	283.7	RC	39
SRC0401	13840.55	19760.64	282.98	RC	26
SRC0402	13720.63	19760.68	294.75	RC	35
SRC0403	13973.41	19859.55	279.42	RC	40
SRC0404	14019.92	19940.14	287.33	RC	38
SRC0405	13779.81	20059.88	280.92	RC	40
SRC0406	13780.16	20179.87	284.06	RC	39
SRC0407	13770.71	20287.97	284.9	RC	32
SRC0408	13719.86	20241.51	279.17	RC	30
SRC0409	13666.85	20300.52	283.69	RC	34

BHID	Easting	Northing	RL	Hole Type	Depth
SRC0410	13716.87	20353.9	283.79	RC	34
SRC0411	13838.94	20251.38	283.74	RC	37
SRC0412	13960.1	20239.77	282.79	RC	39
SRC0413	14027.84	20184.06	281.99	RC	38
SRC0414	13963.87	20127.62	279.62	RC	32
SRC0415	14201.77	20000.13	281.97	RC	20
SRC0416	13839.8	20360.03	285.1	RC	32
SRC0417	14020.2	20299.65	278.43	RC	28
SRC0418	11080.08	22219.76	299.84	RC	19
SRC0419	11079.93	22100.04	296.9	RC	27
SRC0420	11139.87	22159.93	299.2	RC	24
SRC0421	11139.82	22100.11	297.72	RC	27
SRC0422	11140	22039.99	296.33	RC	37
SRC0423	11139.8	21980.12	295.24	RC	45
SRC0424	11199.81	22215.28	301.05	RC	21
SRC0425	11199.88	22040.03	297.1	RC	44
SRC0426	11380.07	22165.23	302.1	RC	33
SRC0427	11199.83	21920.21	294.32	RC	40
SRC0428	11199.81	21800.18	291.27	RC	51
SRC0429	11259.91	22159.98	299.85	RC	33
SRC0430	11259.98	22100.17	300.12	RC	45
SRC0431	11260.16	22039.7	298.82	RC	45
SRC0432	11259.98	21980.14	297.09	RC	45
SRC0433	11259.86	21920.21	295.25	RC	45
SRC0434	11331.32	22217.9	301.54	RC	38
SRC0435	11319.85	22159.9	300.84	RC	38
SRC0436	11319.99	22039.93	299.61	RC	45
SRC0437	11320.1	21919.88	295.92	RC	47
SRC0438	11320.08	21800.03	292.42	RC	51
SRC0439	11379.99	22099.99	300.91	RC	41
SRC0440	11380.08	22040.04	298.91	RC	40
SRC0441	11379.89	21979.6	297.38	RC	45
SRC0442	11379.97	21920.14	295.83	RC	50
SRC0443	11379.98	21860.02	294.31	RC	46
SRC0444	11439.97	22159.69	302.81	RC	37
SRC0445	11440.27	22039.84	299.08	RC	39
SRC0446	11439.77	21920.09	296.21	RC	43
SRC0447	11499.93	22159.68	302.57	RC	32
SRC0448	11500.01	22099.85	301.09	RC	33
SRC0449	11499.88	22040.22	299.6	RC	39
SRC0450	11500.02	21980.02	298.41	RC	44
SRC0451	11500.14	21919.98	296.91	RC	45
SRC0452	11500.1	21859.9	295.6	RC	48
SRC0453	11500.11	21800.15	293.99	RC	50
SRC0454	11500.17	21739.89	292.08	RC	45
SRC0455	11620.08	22099.67	303.29	RC	34
SRC0456	11570.79	22037.36	300.97	RC	38
SRC0457	11560.33	21919.6	297.69	RC	41
SRC0458	11559.88	21800.53	293.65	RC	45
SRC0459	11559.96	21679.88	290.11	RC	40
SRC0460	11567.19	21559.45	287.14	RC	43
SRC0461	11619.96	21740.05	291.3	RC	45
SRC0462	11388.56	22229.13	302.29	RC	39
SRC0463	11500.13	22219.7	304.09	RC	30
SRC0464	11560.37	22160.27	303.02	RC	37
SRC0465	10779.74	20900.39	290.52	RC	20
SRC0466	10719.72	20959.94	290.43	RC	20
SRC0467	10839.81	20900	290.32	RC	35
SRC0468	10900.01	20900.12	290.11	RC	36
SRC0469	10959.97	20899.97	289.79	RC	45
SRC0470	11019.93	20900.03	289.1	RC	39
SRC0471	11079.9	20900.06	287.47	RC	39
SRC0472	11139.57	20900.13	286.88	RC	40
SRC0473	11199.94	20899.84	286.38	RC	42

**Clean TeQ Holdings Limited**  
 ABN 34 127 457 916

Ferntree Business Park  
 12/21 Howleys Rd, Notting Hill VIC Australia 3168  
 PO Box 227, Mulgrave VIC 3170 Australia  
 T: +61 3 9797 6700 F: +61 3 9706 8344  
 W: [www.cleanteq.com](http://www.cleanteq.com) E: [Info@cleanteq.com](mailto:Info@cleanteq.com)

BHID	Easting	Northing	RL	Hole Type	Depth
SRC0474	11199.95	20959.71	286.58	RC	39
SRC0475	11140.14	20959.88	286.81	RC	39
SRC0476	11020.24	20959.82	288.78	RC	39
SRC0477	10959.68	20959.78	289.46	RC	42
SRC0478	10899.96	20960.06	289.63	RC	39
SRC0479	10779.79	21020.88	289.72	RC	45
SRC0480	10839.99	21020.01	289.28	RC	32
SRC0481	10900.28	21020.19	289.07	RC	33
SRC0482	10959.93	21020.04	288.61	RC	39
SRC0483	11019.67	21020.13	288.11	RC	36
SRC0484	11079.66	21020.08	287.44	RC	33
SRC0485	11140.26	21020.24	286.65	RC	39
SRC0486	11199.85	21020.04	286.39	RC	45
SRC0487	11139.76	21079.88	286.44	RC	45
SRC0488	11079.98	21079.9	286.86	RC	39
SRC0489	13240.1	20420.33	284.38	RC	42
SRC0490	13240.24	20240.22	285.77	RC	39
SRC0491	13239.72	20180.27	286.12	RC	43
SRC0492	11269.98	21020.08	286.01	RC	45
SRC0493	11325.09	21019.94	285.85	RC	51
SRC0494	11320.13	21079.76	285.66	RC	45
SRC0495	11264.52	21140.34	285.67	RC	50
SRC0496	11200.05	21139.45	285.98	RC	38
SRC0497	11140.49	21140.22	286.26	RC	39
SRC0498	11195.57	21199.61	286.06	RC	38
SRC0499	11139.9	21200.27	286.23	RC	39
SRC0500	11260.2	21200.25	285.62	RC	36
SRC0501	11319.88	21200.03	285.4	RC	42
SRC0502	11379.58	21200.19	285.15	RC	42
SRC0503	11379.72	21260	285.36	RC	42
SRC0504	11260.04	21260.08	286.1	RC	42
SRC0505	11319.95	21320.09	286.14	RC	49
SRC0506	11260.03	21319.93	286.52	RC	42
SRC0507	11200.29	21319.81	287.02	RC	50
SRC0508	11147.65	21320.94	287.81	RC	39
SRC0509	11140.35	21260.25	287.03	RC	39
SRC0510	11139.88	21379.82	289.57	RC	45
SRC0511	11199.94	21380.35	287.73	RC	43
SRC0512	11259.72	21380.31	286.92	RC	44
SRC0513	11319.71	21439.64	286.84	RC	48
SRC0514	11200.16	21439.83	288.29	RC	45
SRC0515	11140.36	21439.64	290.25	RC	45
SRC0516	11139.98	21499.98	290.25	RC	37
SRC0517	11080.03	21500.36	292.23	RC	41
SRC0518	11019.98	21500.01	294.01	RC	33
SRC0519	11020.07	21560.11	294.09	RC	39
SRC0520	11079.79	21560.31	291.57	RC	48
SRC0521	11139.72	21559.95	289.81	RC	42
SRC0522	11199.87	21560.08	288.54	RC	45
SRC0523	11079.47	21679.51	290.08	RC	45
SRC0524	11020	21619.94	292.9	RC	45
SRC0525	11139.57	21676.96	289.22	RC	47
SRC0526	11020.22	21680.08	291.6	RC	42
SRC0527	10960.03	21619.83	295.15	RC	43
SRC0528	10962.59	21500.39	293.97	RC	39
SRC0529	10900.39	21559.97	296.58	RC	33
SRC0530	10899.93	21499.86	295.26	RC	33
SRC0531	11019.7	21439.79	293.42	RC	42
SRC0532	11017.86	21379.83	291.63	RC	42
SRC0533	10960.27	21380.31	291.18	RC	35
SRC0534	10910.56	21380.47	293.41	RC	33
SRC0535	10898.61	21438.74	293.65	RC	27
SRC0536	10900.01	21320.19	293.64	RC	30
SRC0537	11017.48	21322.76	289.44	RC	37

BHID	Easting	Northing	RL	Hole Type	Depth
SRC0538	10900.69	21622.47	297.81	RC	39
SRC0539	10959.94	21680.49	293.7	RC	48
SRC0540	11079.57	21380.55	293.03	RC	42
SRC0541	11079.69	21258.58	287.49	RC	36
SRC0542	11022.11	21262.42	288.09	RC	33
SRC0543	10959.18	21259.68	289.62	RC	31
SRC0544	10900.97	21259.29	291.54	RC	24
SRC0545	11019.98	21199.4	286.8	RC	29
SRC0546	10959.61	21199.65	286.67	RC	33
SRC0547	10899.89	21200.02	286.96	RC	24
SRC0548	10839.95	21200.11	287.6	RC	24
SRC0549	10817.77	21253.86	287.61	RC	21
SRC0550	10746.51	21192.61	287.99	RC	21
SRC0551	10900.85	21153.65	287.42	RC	27
SRC0552	10959.45	21148.88	287.28	RC	33
SRC0553	11020.55	21144.99	286.83	RC	35
SRC0554	11074.89	21139.73	286.73	RC	32
SRC0555	11625.6	21624.77	288.67	RC	41
SRC0556	11675.74	21680.49	289.88	RC	39
SRC0557	11739.83	21619.91	288.71	RC	39
SRC0558	11800.17	21559.7	287.1	RC	33
SRC0559	11859.85	21620.13	288.86	RC	33
SRC0560	11979.57	21620.15	290.73	RC	44
SRC0561	11859.87	21140.12	284.7	RC	42
SRC0562	11618.83	21075.5	286.32	RC	54
SRC0563	11560.11	21020.25	287.74	RC	42
SRC0564	11500.12	21019.56	287.1	RC	48
SRC0565	11620.35	21020.43	287.63	RC	44
SRC0566	11620.4	20959.94	288.59	RC	55
SRC0567	11619.94	20900.16	289.14	RC	49
SRC0568	11620.26	20840.23	289.47	RC	44
SRC0569	11615.79	21499.18	286.23	RC	43
SRC0570	11680.24	21440.66	284.93	RC	43
SRC0571	11739.3	21500.61	286.07	RC	36
SRC0572	11799.08	21442.49	284.63	RC	39
SRC0573	11739.86	21380.68	283.92	RC	45
SRC0574	11800.05	21319.8	283.77	RC	39
SRC0575	11877.3	21378.93	283.4	RC	33
SRC0576	11980.57	21380.16	283.31	RC	33
SRC0577	12094.25	21380.6	283.08	RC	31
SRC0578	11860.97	21498.86	285.85	RC	31
SRC0579	11620.21	20779.97	289.89	RC	48
SRC0580	11499.66	20779.91	290.01	RC	45
SRC0581	11499.64	20840.04	289.7	RC	44
SRC0582	11499.47	20904.71	288.92	RC	44
SRC0583	11499.93	20959.68	287.92	RC	42
SRC0584	11560.16	20899.94	289.32	RC	44
SRC0585	11440.64	20899.6	287.93	RC	42
SRC0586	11984.39	21500.18	286.78	RC	31
SRC0587	12099.8	21499.86	287.39	RC	33
SRC0588	12156.25	21435.83	285.3	RC	35
SRC0589	12519.15	21800.38	296.84	RC	33
SRC0590	12459.99	21800.4	294.42	RC	36
SRC0591	12460.36	21739.81	295.72	RC	41
SRC0592	12399.67	21740.08	293.47	RC	29
SRC0593	12339.89	21739.55	292.9	RC	41
SRC0594	12220.11	21739.52	296.01	RC	50
SRC0595	12339.03	21618.91	290	RC	36
SRC0596	12459.87	21680.21	293.12	RC	38
SRC0597	12515.27	21685	294.12	RC	39
SRC0598	12459.96	21619.76	290.2	RC	37
SRC0599	12580.07	21679.47	292.57	RC	33
SRC0600	12571.72	21627.15	291.26	RC	37
SRC0601	12463.19	21563.86	288.02	RC	37

Clean TeQ Holdings Limited  
 ABN 34 127 457 916

Ferntree Business Park  
 12/21 Howleys Rd, Notting Hill VIC Australia 3168  
 PO Box 227, Mulgrave VIC 3170 Australia  
 T: +61 3 9797 6700 F: +61 3 9706 8344  
 W: [www.cleanteq.com](http://www.cleanteq.com) E: [Info@cleanteq.com](mailto:Info@cleanteq.com)



BHID	Easting	Northing	RL	Hole Type	Depth
SRC0602	12523.04	21554.86	289.24	RC	33
SRC0603	11380.21	20900.1	286.85	RC	42
SRC0604	11379.91	20840.3	287.71	RC	46
SRC0605	11380.24	20780.26	288.56	RC	44
SRC0606	11259.4	20780.11	287.48	RC	42
SRC0607	11260.01	20839.51	286.79	RC	46
SRC0608	11326.6	20886.91	286.66	RC	44
SRC0609	11739.68	20780.05	289.3	RC	44
SRC0610	12580.04	21559.71	290.59	RC	31
SRC0611	12579.4	21500.38	289.79	RC	37
SRC0612	12640.38	21500.13	287.81	RC	32
SRC0613	12700.03	21440.01	285.62	RC	27
SRC0614	11619.58	22159.73	304.19	RC	39
SRC0615	11619.08	22218.08	305.28	RC	30
SRC0616	11499.82	22279.99	306.6	RC	18
SRC0617	11390.88	22286.83	303.45	RC	27
SRC0618	12999.58	21140.05	278.95	RC	36
SRC0619	12940.27	21080.12	279.52	RC	48
SRC0620	12889.12	21011.14	281.21	RC	42
SRC0621	12880.24	20960.18	282.31	RC	43
SRC0622	11919.83	20720.07	288.82	RC	39
SRC0623	12266.82	20254.4	289.7	RC	33
SRC0624	12160.2	20240.11	289.92	RC	36
SRC0625	12216.4	20174.25	290.77	RC	36
SRC0626	12939.87	21020.16	280.82	RC	45
SRC0627	12999.97	20960.3	281.68	RC	43
SRC0628	13000.31	21020.09	280.47	RC	45
SRC0629	13060.34	21020.08	280.11	RC	51
SRC0630	13120.03	20960.3	280.9	RC	44
SRC0631	12459.81	21500.21	285.79	RC	32
SRC0632	12519.96	21497.85	287.21	RC	33
SRC0633	12520.18	21440.17	285.33	RC	39
SRC0634	12100.26	20180.17	290.58	RC	37
SRC0635	12099.85	20060.01	292.46	RC	36
SRC0636	11920.22	20000.12	294.05	RC	32
SRC0637	11920.14	20240.6	290.15	RC	30
SRC0638	12340.59	20900.54	286.91	RC	30
SRC0639	12278.92	20899.99	287.26	RC	35
SRC0640	12219.96	20900.3	287.62	RC	34
SRC0641	12160.67	20900.37	288	RC	34
SRC0642	12099.71	20900.24	288.22	RC	32
SRC0643	12040.17	20900.33	288.15	RC	35
SRC0644	11920.82	20960.28	287.2	RC	48
SRC0645	11981.14	20959.95	287.48	RC	45
SRC0646	12100.45	20959.99	287.83	RC	36
SRC0647	12160.69	20955.12	287.52	RC	36
SRC0648	12460.02	21380.41	281.94	RC	30
SRC0649	12399.89	21439.96	284.19	RC	41
SRC0650	12581.32	21444.53	288.18	RC	37
SRC0651	12580.25	21380.2	285.13	RC	38
SRC0652	12579.84	21320.34	281.32	RC	29
SRC0653	12582.6	21265.56	280.02	RC	31
SRC0654	12639.56	21257.09	280.23	RC	32
SRC0655	12699.91	21259.98	280.58	RC	33
SRC0656	12704.06	21320.81	281.06	RC	33
SRC0657	12700.3	21379.68	281.65	RC	26
SRC0658	11688.8	20960.56	288.18	RC	43
SRC0659	12039.63	21019.95	287.08	RC	35
SRC0660	12099.92	21024.96	287.05	RC	33
SRC0661	12219.4	21020.04	286.71	RC	26
SRC0662	12279.89	21020.13	286.2	RC	29
SRC0663	12640.13	21200.04	280.17	RC	35
SRC0664	12700.03	21199.79	279.45	RC	33
SRC0665	12639.6	21319.88	281.02	RC	39

BHID	Easting	Northing	RL	Hole Type	Depth
SRC0666	12760.09	21256.21	280.22	RC	31
SRC0667	12820.31	21257.98	280.21	RC	21
SRC0668	12820.68	21200.82	278.53	RC	35
SRC0669	12339.64	21019.69	285.77	RC	30
SRC0670	12399.64	21019.67	285.32	RC	32
SRC0671	12397.78	21081.38	284.3	RC	30
SRC0672	12339.78	21080.6	284.98	RC	26
SRC0673	12274.77	21080.75	285.73	RC	30
SRC0674	12220.17	21080.07	285.83	RC	30
SRC0675	11501.2	21079.9	285.32	RC	44
SRC0676	11378.44	21079.1	285.53	RC	40
SRC0677	11380.01	21020.3	285.74	RC	32
SRC0678	11375.1	20964.57	285.93	RC	46
SRC0679	11440.37	21020.15	285.84	RC	42
SRC0680	12160.03	21079.74	285.83	RC	26
SRC0681	12100.18	21079.88	286.06	RC	26
SRC0682	12043.77	21079.69	286.09	RC	30
SRC0683	11980.02	21079.9	285.82	RC	34
SRC0684	11860.05	21080.11	286.49	RC	39
SRC0685	11918.93	21140.38	285.04	RC	36
SRC0686	11979.37	21140.04	284.86	RC	27
SRC0687	12104.36	21139.3	285.09	RC	24
SRC0688	12159.75	21140.27	284.72	RC	26
SRC0689	12219.45	21140.31	284.47	RC	30
SRC0690	12279.26	21140.56	285.1	RC	27
SRC0691	12880.16	21199.78	279.05	RC	16
SRC0692	12820.24	21139.93	279.62	RC	36
SRC0693	12761.16	21137.93	280.12	RC	37
SRC0694	12819.68	21079.97	279.83	RC	42
SRC0695	12879.78	21140.6	279.51	RC	35
SRC0696	12939.72	21134.67	279.54	RC	32
SRC0697	13296.25	20721.59	280.24	RC	51
SRC0698	13296.12	20771.61	280.04	RC	48
SRC0699	13299.87	20659.6	281.37	RC	51
SRC0700	13241.78	20657.98	281.07	RC	45
SRC0701	13180.34	20660.24	280.92	RC	51
SRC0702	11259.87	20959.8	286.3	RC	43
SRC0703	11259.8	20900.59	286.2	RC	40
SRC0704	11621.9	21136.58	284.73	RC	37
SRC0705	11560.67	21140.36	284.87	RC	41
SRC0706	12342.09	21135.93	284.14	RC	30
SRC0707	12220.03	21199.76	283.18	RC	23
SRC0708	12035.36	21199.53	283.93	RC	26
SRC0709	12040.5	21318.32	282.68	RC	32
SRC0710	12100.26	21260.17	282.48	RC	23
SRC0711	12215.56	21256.11	282.54	RC	24
SRC0712	12400.52	20959.93	286.07	RC	38
SRC0713	12340.23	20960.28	286.41	RC	32
SRC0714	13120.33	20719.45	280.81	RC	51
SRC0715	13180.72	20599.82	281.65	RC	54
SRC0716	13180.26	20540.31	282.75	RC	44
SRC0717	13180.27	20479.83	283.49	RC	43
SRC0718	13180.27	20359.96	284.44	RC	41
SRC0719	13179.93	20299.77	285	RC	33
SRC0720	13179.99	20240.21	285.42	RC	33
SRC0721	13180.11	20180.02	285.61	RC	35
SRC0722	13180.04	20120.14	286.32	RC	39
SRC0723	13300.37	20179.84	285.97	RC	33
SRC0724	13299.56	20240.02	285.44	RC	38
SRC0725	13299.65	20300.22	284.97	RC	45
SRC0726	13299.77	20360.1	284.26	RC	41
SRC0727	11500.3	21140.14	284.97	RC	44
SRC0728	11439.71	21139.56	285.21	RC	44
SRC0729	11379.77	21139.11	285.35	RC	43

Clean TeQ Holdings Limited  
 ABN 34 127 457 916

Ferntree Business Park  
 12/21 Howleys Rd, Notting Hill VIC Australia 3168  
 PO Box 227, Mulgrave VIC 3170 Australia  
 T: +61 3 9797 6700 F: +61 3 9706 8344  
 W: [www.cleanteq.com](http://www.cleanteq.com) E: [Info@cleanteq.com](mailto:Info@cleanteq.com)

BHID	Easting	Northing	RL	Hole Type	Depth
SRC0730	10840.03	21140.02	288.17	RC	27
SRC0731	12220.3	20960.08	287.02	RC	34
SRC0732	11260.3	21079.45	285.97	RC	41
SRC0733	11020.13	21079.67	287.16	RC	42
SRC0734	10899.82	21079.91	288.22	RC	28
SRC0735	10840.36	21080.41	288.87	RC	29
SRC0736	13059.95	20060.09	287.56	RC	40
SRC0737	13059.4	20120.11	286.6	RC	48
SRC0738	13059.94	20180.23	286.06	RC	40
SRC0739	13299.48	20419.71	284.29	RC	44
SRC0740	13359.91	20420.31	283.86	RC	41
SRC0741	13359.95	20300.35	284.21	RC	42
SRC0742	13360.2	20240.25	284.8	RC	42
SRC0743	13419.99	20240.17	284.07	RC	39
SRC0744	13419.71	20299.88	284	RC	38
SRC0745	13419.99	20359.63	283.58	RC	41
SRC0746	10778.19	21140.94	288.45	RC	25
SRC0747	13419.57	20419.92	283.4	RC	45
SRC0748	13419.64	20480.08	283.1	RC	39
SRC0749	13419.28	20539.96	282.98	RC	43
SRC0750	13412.13	20593.72	282.41	RC	39
SRC0751	13478.63	20479.22	282.6	RC	42
SRC0752	13059.86	20239.85	285.3	RC	38
SRC0753	13060.1	20360.25	284.07	RC	30
SRC0754	13518.81	20423.51	282.32	RC	45
SRC0755	13540.67	20359.38	282.63	RC	39
SRC0756	13059.83	20479.65	283.08	RC	39
SRC0757	13059.94	20419.74	283.72	RC	36
SRC0758	13059.74	20539.59	282.54	RC	39
SRC0759	13119.98	20479.96	283.25	RC	41
SRC0760	13120.31	20539.69	282.43	RC	40
SRC0761	13746.74	20827.66	280.34	RC	34
SRC0762	13571.44	20764.08	279.94	RC	47
SRC0763	13486.05	20729.3	281.05	RC	34
SRC0764	13375.45	20763.81	279.88	RC	42
SRC0765	13395.32	20704.92	280.94	RC	52
SRC0766	13480.09	20619.7	282.06	RC	41
SRC0767	13119.73	20419.64	283.72	RC	47
SRC0768	13119.86	20359.84	284.17	RC	32
SRC0769	13120.18	20239.65	285.26	RC	33
SRC0770	13120.26	20180.73	285.82	RC	33
SRC0771	12879.58	19759.79	294.43	RC	42
SRC0772	12879.75	19940.94	291.23	RC	42
SRC0773	12880.48	20001.45	290.22	RC	42
SRC0774	12879.97	20119.53	288.05	RC	42
SRC0775	13596.13	20299.89	283.23	RC	39
SRC0776	13539.83	20299.75	283.29	RC	38
SRC0777	13484.37	20289.89	283.53	RC	38
SRC0778	12999.73	20059.87	287.83	RC	39
SRC0779	12999.75	20119.79	287.15	RC	41
SRC0780	12999.76	20180.46	286.41	RC	39
SRC0781	12999.57	20239.98	285.69	RC	38
SRC0782	13715.75	20522.28	282.56	RC	43
SRC0783	13671.63	20449.65	282.58	RC	40
SRC0784	13598.13	20434.16	282.24	RC	39
SRC0785	13000.1	20299.79	285.03	RC	39
SRC0786	12999.9	20420.28	283.71	RC	35
SRC0787	12999.76	20540.1	282.5	RC	39
SRC0788	12939.69	20540.13	283.01	RC	39
SRC0789	12940.39	20480.12	283.56	RC	42
SRC0790	12939.08	20419.61	284.15	RC	43
SRC0791	12880.17	20178.77	287.23	RC	40
SRC0792	12880.24	20299.17	285.79	RC	41
SRC0793	12880.34	20419.79	284.54	RC	42

BHID	Easting	Northing	RL	Hole Type	Depth
SRC0794	12820.08	20420.27	285	RC	40
SRC0795	12820.14	20359.86	285.59	RC	40
SRC0796	12819.87	20180.97	287.7	RC	42
SRC0797	12820.09	20060.08	289.83	RC	41
SRC0798	12820.04	19940.66	292.61	RC	42
SRC0799	12820.16	19820.54	295.19	RC	36
SRC0800	13720.11	20428.05	283.19	RC	40
SRC0801	13788.94	20509.28	282.67	RC	43
SRC0802	13603.05	20734.15	280.34	RC	43
SRC0803	13660.43	20695.98	281.45	RC	45
SRC0804	13620.24	20933.5	278.45	RC	36
SRC0805	13571.25	20996.17	277.72	RC	36
SRC0806	12640.02	20059.9	291.86	RC	41
SRC0807	13519.42	20955.25	278.19	RC	25
SRC0808	12639.91	19878.2	296.85	RC	31
SRC0809	12639.86	19948.62	294.82	RC	36
SRC0810	12640.1	19999.64	293.62	RC	36
SRC0811	12940.38	20359.99	284.77	RC	35
SRC0812	12940.57	20300.07	285.4	RC	36
SRC0813	12940.34	20239.91	286.05	RC	39
SRC0814	12940.42	20179.83	286.88	RC	44
SRC0815	12940.44	20119.98	287.59	RC	44
SRC0816	12940.5	20059.87	288.56	RC	39
SRC0817	12938.98	20004.04	289.3	RC	41
SRC0818	12940.13	19879.58	291.5	RC	38
SRC0819	12940.15	19819.56	292.44	RC	42
SRC0820	12519.63	20000.26	293.43	RC	33
SRC0821	12519.72	19760.1	300.58	RC	27
SRC0822	12519.98	19880.05	296.32	RC	31
SRC0823	12639.94	20119.51	290.43	RC	42
SRC0824	12639.94	20239.83	288.17	RC	42
SRC0825	12640.07	20359.49	286.93	RC	41
SRC0826	12641.04	20479.88	285.47	RC	38
SRC0827	12820.22	19701.41	297.36	RC	41
SRC0828	12759.89	19759.18	296.73	RC	41
SRC0829	12759.34	19879.95	295.43	RC	38
SRC0830	12759.53	19999.45	292.17	RC	42
SRC0831	12759.97	20119.24	289.33	RC	45
SRC0832	12759.84	20239.1	287.38	RC	41
SRC0833	12700.18	20180.78	288.64	RC	38
SRC0834	12699.93	20060.29	291.59	RC	42
SRC0835	12699.55	19939.83	294.84	RC	39
SRC0836	12700.46	19820	298.21	RC	39
SRC0837	12580.25	20179.97	289.55	RC	40
SRC0838	12519.82	20119.96	290.8	RC	39
SRC0839	12519.66	20239.93	288.88	RC	41
SRC0840	12460.44	20179.78	289.83	RC	38
SRC0841	12460.36	20059.92	292.18	RC	41
SRC0842	12460.04	19940.01	294.6	RC	32
SRC0843	12460.32	19820.19	298.21	RC	25
SRC0844	12400.08	19880.2	296.22	RC	26
SRC0845	12399.91	20000	293.57	RC	33
SRC0846	12400.01	20120.48	291.02	RC	41
SRC0847	12399.99	20240.27	289.49	RC	37
SRC0848	12339.94	20180.15	290.48	RC	36
SRC0849	12340.28	20060.11	292.61	RC	43
SRC0850	13599.71	20239.34	283.66	RC	40
SRC0851	13599.26	20180.32	284.06	RC	43
SRC0852	13540.38	20120.02	284.77	RC	37
SRC0853	13479.78	20059.56	286.02	RC	37
SRC0854	13418.86	20000.91	286.82	RC	40
SRC0855	13360.15	19940.1	286.68	RC	40
SRC0856	13300.08	19880.44	285.86	RC	40
SRC0857	13240.11	19820.1	286.56	RC	37

BHID	Easting	Northing	RL	Hole Type	Depth
SRC0858	13179.5	19759.88	288.23	RC	43
SRC0859	13239.56	19700.09	288.05	RC	31
SRC0860	13301.09	19760.46	286.65	RC	37
SRC0861	12340.05	19939.83	295.21	RC	35
SRC0862	12340.31	19820.12	298.21	RC	35
SRC0863	12219.81	19939.76	296.54	RC	39
SRC0864	12220.05	20060.44	292.66	RC	37
SRC0865	12100.03	19820.54	298.84	RC	25
SRC0866	13361	19820.31	286.64	RC	35
SRC0867	13421.11	19880.44	287.63	RC	37
SRC0868	13479.61	19940.09	287.73	RC	43
SRC0869	13539.89	20000.07	287.75	RC	43
SRC0870	13599.29	20059.51	286.37	RC	49
SRC0872	13720.19	20057.81	285.4	RC	44
SRC0873	13659.4	19998.75	287.22	RC	40
SRC0874	13600.18	19940.16	288.54	RC	43
SRC0875	13539.9	19880.16	287.36	RC	37
SRC0876	12579.79	20061.05	291.87	RC	41
SRC0877	12580.22	19940.19	295.24	RC	36
SRC0878	12580.19	19820.19	298.56	RC	36
SRC0879	13540.36	20240.06	283.76	RC	36
SRC0880	13420.14	20179.82	285.1	RC	42
SRC0881	13180.01	20059.9	286.66	RC	36
SRC0882	13061.5	20002.09	288.33	RC	42
SRC0883	12934.75	19946.07	290.35	RC	42
SRC0884	13120.65	20060.42	287.09	RC	40
SRC0885	13059.77	19939.72	286.08	RC	36
SRC0886	13180.12	20000.69	287.77	RC	40
SRC0887	13299.78	20059.84	286.7	RC	38
SRC0888	12578.6	21743.24	294.33	RC	27
SRC0889	13359.72	20119.78	286.15	RC	40
SRC0890	13240.76	20059.87	286.82	RC	36
SRC0891	13240.27	19999.81	287.17	RC	36
SRC0892	13179.76	19939.38	287.75	RC	30
SRC0893	13119.41	19940.48	286.85	RC	30
SRC0894	13180.2	19880.83	286.92	RC	34
SRC0895	13472.69	19829.37	288.22	RC	28
SRC0896	13359.97	19699.88	290.44	RC	28
SRC0897	13300.18	19639.94	290.49	RC	19
SRC0898	13481.88	19641.15	287.13	RC	19
SRC0899	13545.87	19695.68	290.11	RC	25
SRC0900	13600.38	19760.15	295.67	RC	30
SRC0901	13600.18	19820.7	293.61	RC	31
SRC0902	13659.47	19760.94	295.3	RC	31
SRC0903	13779.94	19699.94	293.44	RC	27
SRC0904	13900.69	19761.2	284.24	RC	33
SRC0905	13840.03	19820.09	284.64	RC	31
SRC0906	12160.06	19639.7	297.98	RC	16
SRC0907	12042.82	19518.76	293.09	RC	24
SRC0908	12280.13	19398.7	291.75	RC	15
SRC0909	12640.91	19279.77	287.28	RC	19
SRC0910	12400.6	19038.53	288.82	RC	7
SRC0911	12160.25	19277.31	289.55	RC	7
SRC0912	12041.7	19398.21	290.72	RC	19
SRC0913	11917.69	19039.4	285.93	RC	13
SRC0914	13127.72	20120.13	286.43	RC	39
SRC0915	11258.5	22214.73	301.08	RC	17
SRC0916	13239.78	19940.18	286.88	RC	38
SRC0917	13300.25	20000.15	287.16	RC	42
SRC0918	13359.84	20059.67	287.54	RC	36
SRC0919	13115.54	19754.47	288.64	RC	47
SRC0920	13047.27	19749.25	290.22	RC	42
SRC0921	12996.25	19816.83	291.4	RC	42
SRC0922	13720.63	19939.24	288.08	RC	41

BHID	Easting	Northing	RL	Hole Type	Depth
SRC0923	13719.63	20000.03	286.3	RC	38
SRC0924	13009.46	19886.3	285.14	RC	36
SRC0925	13059.46	19886.35	287.11	RC	33
SRC0926	11140.81	21919.73	293.8	RC	54
SRC0927	11141.12	21861.16	292.45	RC	47
SRC0928	11259.27	21860.42	293.44	RC	48
SRC0929	12458.33	21019.15	285.01	RC	33
SRC0930	12460.11	20959.84	285.56	RC	38
SRC0931	12461.58	20901.35	286.04	RC	30
SRC0932	12401.63	20901.45	286.48	RC	32
SRC0933	12339.94	20840.52	287.18	RC	33
SRC0934	12217.9	20839.78	288.06	RC	40
SRC0935	11984.03	21016.01	286.86	RC	36
SRC0936	11739.65	21021.68	287.34	RC	48
SRC0937	11675.03	21022.23	287.49	RC	51
SRC0938	11680.49	20900.76	288.84	RC	48
SRC0939	11739.3	20899.86	288.8	RC	44
SRC0940	11680.67	20781.05	289.71	RC	52
SRC0941	11738.21	20720.03	289.53	RC	45
SRC0942	11561.29	20779.3	290.12	RC	48
SRC0943	12281.28	21739.4	294.9	RC	50
SRC0944	12457.75	21856.72	293.39	RC	24
SRC0945	13780.3	19879.92	287.54	RC	37
SRC0946	13718.49	19830.74	286.85	RC	32
SRC0947	13921.14	19710.88	287.66	RC	31
SRC0948	13917.97	19492.29	286.23	RC	19
SRC0949	13964.39	19536.55	287.03	RC	13
SRC0950	14008.65	19580.91	285.98	RC	17
SRC0951	13740.05	19548.71	287.5	RC	10
SRC0952	13775.25	19591.2	287.84	RC	19
SRC0953	13832	19689.82	292.22	RC	25
SRC0954	13849.26	19638.87	296.32	RC	34
SRC0955	12160.43	18798.67	286.84	RC	19
SRC0956	13138.3	19825.92	287.62	RC	48
SRC0957	13060.2	19700.08	290.25	RC	47
SRC0958	13000.93	19760.32	291.64	RC	42
SRC0959	12941.5	19700.33	293.56	RC	44
SRC0960	12959.03	19633.97	292.76	RC	45
SRC0961	12929.14	19598.39	292.96	RC	33
SRC0962	12818.92	19580.11	294.61	RC	38
SRC0963	12699.8	19579.92	295.47	RC	20
SRC0964	12819.87	19459.92	289.17	RC	18
SRC0965	12700.21	19459.63	289.92	RC	8
SRC0966	12219.98	19700.17	300.87	RC	18
SRC0967	12407.99	19764.29	298.91	RC	18
SRC0968	12219.92	19820.52	301.11	RC	42
SRC0969	12160.4	19759.86	301.51	RC	40
SRC0970	12098.58	19701.52	301.02	RC	12
SRC0971	13058.77	21133.92	278.67	RC	33
SRC0972	13960.19	19698.73	285.73	RC	30
SRC0973	14005.15	19664.85	285.54	RC	34
SRC0974	12991.65	21206.34	278.15	RC	32
SRC0975	12698.54	21570.71	285.68	RC	3
SRC0976	12641.42	21674.38	289.03	RC	8
SRC0977	13960.34	19621.81	291.69	RC	35
SRC0978	13902.83	19585.41	296.09	RC	28
SRC0979	13646.34	19707.7	290.37	RC	23
SRC0980	13483.83	19717.38	280.65	RC	11
SRC0981	13854.44	19593.86	293.39	RC	29
SRC0982	11919.73	18558.33	282.7	RC	19
SRC0983	11680.23	18800.1	284.71	RC	37
SRC0984	11679.3	18318.75	284.42	RC	25
SRC0985	11440.46	18559	286.62	RC	19
SRC0986	11798.88	19398.7	288.79	RC	25

**Clean TeQ Holdings Limited**  
 ABN 34 127 457 916

Ferntree Business Park  
 12/21 Howleys Rd, Notting Hill VIC Australia 3168  
 PO Box 227, Mulgrave VIC 3170 Australia  
 T: +61 3 9797 6700 F: +61 3 9706 8344  
 W: [www.cleanteq.com](http://www.cleanteq.com) E: [Info@cleanteq.com](mailto:Info@cleanteq.com)

BHID	Easting	Northing	RL	Hole Type	Depth
SRC0987	11799.72	19639.39	291.96	RC	25
SRC0988	11558.78	19638.6	292.94	RC	29
SRC0989	11318.13	19638.32	293.38	RC	31
SRC0990	11559.47	19878.59	291.83	RC	28
SRC0991	11199.11	18798.67	289.84	RC	31
SRC0992	10958.6	18558.96	294.83	RC	27
SRC0993	11079.23	19638.71	295.47	RC	25
SRC0994	10839.19	19639.54	295.16	RC	31
SRC0995	11197.96	19998.8	292.63	RC	24
SRC0996	13420.69	20117.28	282.6	RC	29
SRC0997	11321.94	19882.21	292.3	RC	23
SRC0998	10838.62	19879.54	294.94	RC	46
SRC0999	11078.09	19878.06	293.46	RC	31
SRC1000	11078.6	20118.58	293.98	RC	24
SRC1001	10478.85	19518.97	298.92	RC	37
SRC1002	11439.33	19999.85	291.19	RC	27
SRC1003	11318.23	20118.67	292.17	RC	25
SRC1004	10959.24	19759.75	294.4	RC	24
SRC1005	10839.28	22280.72	297.46	RC	24
SRC1006	10719.47	22158.7	294.25	RC	26
SRC1007	10598.58	22039.87	294.53	RC	23
SRC1008	10720.18	21922.63	294.51	RC	20
SRC1009	10837.8	22041.79	292.86	RC	23
SRC1010	10479.08	21922.92	299.17	RC	21
SRC1011	10239.41	21681.6	294.8	RC	3
SRC1012	10357.73	21801.01	296.36	RC	3
SRC1013	10599.88	21801.16	295.41	RC	9
SRC1014	10480.68	21681.46	293.87	RC	7
SRC1015	10359.43	21561.54	292.24	RC	6
SRC1016	10601.13	21562.99	291.58	RC	6
SRC1017	10358.12	21319.12	289.47	RC	9
SRC1018	10358.75	21080.51	292.63	RC	27
SRC1019	10357.55	20840.7	298.5	RC	23
SRC1020	10360.63	20599.62	297.24	RC	21
SRC1021	10362.28	20359.27	291.63	RC	15
SRC1022	10599.31	20601.26	295.04	RC	25
SRC1023	10599.19	20838.62	293.3	RC	30
SRC1024	10598.83	20360.37	290.29	RC	17
SRC1025	10478.99	20239.67	291.62	RC	15
SRC1026	10600.52	22284.07	295.32	RC	30
SRC1027	10490.11	22148.75	294.93	RC	36
SRC1028	12280.18	22280.77	290.59	RC	21
SRC1029	12282.39	22039.13	291.9	RC	6
SRC1030	12399.83	21920.14	292.01	RC	9
SRC1031	12519.94	21919.21	293.47	RC	15
SRC1032	12522.04	22039.83	291.05	RC	13
SRC1033	12761.03	22040.03	290.98	RC	39
SRC1034	12999.54	22039.86	286.28	RC	36
SRC1035	12641.12	21922.61	295.38	RC	27
SRC1036	12637.65	21799.88	293.34	RC	29
SRC1037	12758.17	21799.46	290.61	RC	27
SRC1038	13004.23	21568.57	280.42	RC	9
SRC1039	12997.24	21801.09	285.19	RC	12
SRC1040	13357.67	19378.35	282.69	RC	3
SRC1041	13358.71	19058.27	279.23	RC	12
SRC1042	13601.89	19239.3	282.09	RC	6
SRC1043	13840.3	19380.03	285.27	RC	9
SRC1044	13602.23	18757.23	275.89	RC	6
SRC1045	12881.62	19060.94	283.77	RC	15
SRC1046	13240.71	21559.35	278.44	RC	51
SRC1047	13240.19	21802.29	280.97	RC	51
SRC1048	10481.04	21199.5	290.44	RC	24
SRC1049	10596.96	21079.76	291.01	RC	27
SRC1050	11798.78	22522.22	301.68	RC	3

BHID	Easting	Northing	RL	Hole Type	Depth
SRC1051	12039.07	22518.73	294.98	RC	11
SRC1052	12281.44	22517.9	290.78	RC	19
SRC1053	12049.49	22288.87	295.15	RC	3
SRC1054	12518.88	22278.41	287.57	RC	24
SRC1055	11080.12	19757.78	293.74	RC	26
SRC1056	11198.68	19757.25	293.75	RC	27
SRC1057	10957.7	19639.3	294.62	RC	27
SRC1058	10957.71	19538.73	293.22	RC	27
SRC1059	11197.79	19539.24	293.86	RC	27
SRC1060	11191.56	19650.14	294.68	RC	27
SRC1065	10039.54	21578.3	296	RC	27
SRC1068	11549.14	23137.46	304.5	RC	23
SRC1069	11600.05	23209.64	302.3	RC	33
SRC1070	11656.05	23289.03	300	RC	27
SRC1076	11497.59	23064.37	306	RC	15
SRC1077	11920	21500	286.04	RC	28
SRC1078	11920	21620	289.76	RC	34
SRC1079	11920	21740	294.38	RC	36
SRC1080	11982.1	21556.8	288.43	RC	40
SRC1081	11980	21680	292.99	RC	43
SRC1082	11980	21740	295.14	RC	49
SRC1083	11980	21800	297.62	RC	43
SRC1084	12040	21500	287.25	RC	34
SRC1085	12040	21560	289.17	RC	34
SRC1086	12040	21620	291.72	RC	46
SRC1087	12040	21680	294.65	RC	40
SRC1088	12040	21740	296.97	RC	46
SRC1089	10810	20960	290.01	RC	31
SRC1090	10810	20990	289.75	RC	38
SRC1091	10810	21020	289.52	RC	38
SRC1092	10810	21050	289.29	RC	32
SRC1093	10810.1	21080.4	289.04	RC	31
SRC1094	10810	21110.2	288.75	RC	31
SRC1095	10839.75	20930.25	290.09	RC	32
SRC1096	10839.9	20990.25	289.64	RC	31
SRC1097	10840	21050.29	289.03	RC	32
SRC1098	10840	21110	288.34	RC	26
SRC1099	10870	20930	290.01	RC	34
SRC1100	10870	20960	289.78	RC	37
SRC1101	10869.9	20990.12	289.54	RC	37
SRC1102	10870	21020	289.22	RC	31
SRC1103	10870.1	21050	288.87	RC	31
SRC1104	10870	21080	288.44	RC	28
SRC1105	10870	21110	288.11	RC	25
SRC1106	10900	20990	289.4	RC	34
SRC1107	10900	21050	288.57	RC	34
SRC1108	10900	21110	287.82	RC	31
SRC1109	10930	20987.76	289.27	RC	34
SRC1110	10930.1	21019.8	288.83	RC	34
SRC1111	10930	21049.9	288.16	RC	28
SRC1112	10930.1	21079.75	287.8	RC	26
SRC1113	10990.25	21290	288.79	RC	28
SRC1114	10990	21320	289.73	RC	31
SRC1115	10990	21350	290.3	RC	34
SRC1116	11020	21290	288.8	RC	34
SRC1117	11020	21350	290.31	RC	34
SRC1118	11050	21230	286.57	RC	37
SRC1119	11050	21260	287.83	RC	31
SRC1120	11050	21290	288.55	RC	37
SRC1121	11050	21320	289.22	RC	33
SRC1122	11049.9	21349.8	291.09	RC	34
SRC1123	11080	21230	286.7	RC	40
SRC1124	11080	21300	288.37	RC	40
SRC1125	11080	21350	291.01	RC	37

**Clean TeQ Holdings Limited**  
 ABN 34 127 457 916

Ferntree Business Park  
 12/21 Howleys Rd, Notting Hill VIC Australia 3168  
 PO Box 227, Mulgrave VIC 3170 Australia  
 T: +61 3 9797 6700 F: +61 3 9706 8344  
 W: [www.cleanteq.com](http://www.cleanteq.com) E: [Info@cleanteq.com](mailto:Info@cleanteq.com)

BHID	Easting	Northing	RL	Hole Type	Depth
SRC1126	11110	21170	285.91	RC	30
SRC1127	11110	21200	286.41	RC	31
SRC1128	11110	21230	286.87	RC	37
SRC1129	11110	21260	287.23	RC	37
SRC1130	11110	21290	287.7	RC	45
SRC1131	11110	21320	288.8	RC	46
SRC1132	11110	21350	289.85	RC	46
SRC1133	11140	21170	285.63	RC	31
SRC1134	11140	21230	286.6	RC	43
SRC1135	11140	21290	287.37	RC	40
SRC1136	11140	21350	288.79	RC	49
SRC1137	11170	21170	285.44	RC	34
SRC1138	11170	21200	286.2	RC	37
SRC1139	11170.1	21230	286.45	RC	37
SRC1140	11170	21260	286.75	RC	40
SRC1141	11170	21290	287.03	RC	40
SRC1142	11170	21320	287.42	RC	43
SRC1143	11170	21350	287.93	RC	46
SRC1144	11170	21380	288.42	RC	49
SRC1145	11200	21230	286.35	RC	43
SRC1146	11200	21260	286.6	RC	46
SRC1147	11200	21290	286.8	RC	40
SRC1148	11230	21230	286.2	RC	40
SRC1149	11230	21260	286.43	RC	50
SRC1150	11230	21290	286.56	RC	40
SRC1151	11230	21320	286.73	RC	46
SRC1152	11230	21350	286.95	RC	46
SRC1153	11230	21380	287.18	RC	44
SRC1154	11890	21590	288.419	RC	34
SRC1155	11890	21620	289.218	RC	34
SRC1156	11890	21650	290.116	RC	33
SRC1157	11890	21680	291.263	RC	37
SRC1158	11890	21710	292.476	RC	37
SRC1159	11888.51	21740	294.124	RC	40
SRC1160	11890	21770	295.467	RC	44
SRC1161	11920	21530	286.862	RC	40
SRC1162	11920	21590	288.815	RC	37
SRC1163	11920	21650	290.758	RC	40
SRC1164	11920	21710	293.117	RC	40
SRC1165	11920	21770	295.793	RC	34
SRC1166	11950	21530	287.314	RC	37
SRC1167	11950	21560	288.2	RC	34
SRC1168	11950	21590.1	289.15	RC	40
SRC1169	11950	21620	290.182	RC	37
SRC1170	11950	21650	291.273	RC	40
SRC1171	11950	21679.9	292.403	RC	37
SRC1172	11950	21709.8	293.544	RC	34
SRC1173	11950.2	21740	294.775	RC	34
SRC1174	11947.36	21770	296.124	RC	37
SRC1175	11980	21530	287.574	RC	32
SRC1176	11979.8	21589.8	289.393	RC	43
SRC1177	11980	21650	291.754	RC	40
SRC1178	11980	21710	294.054	RC	37
SRC1179	11980	21770	296.269	RC	43
SRC1180	12008.5	21528.5	287.787	RC	37
SRC1181	12010	21559.8	288.752	RC	40
SRC1182	12010	21590	289.829	RC	37
SRC1183	12010	21619.8	291.024	RC	40
SRC1184	12010	21649.8	292.468	RC	32
SRC1185	12010	21680.1	293.765	RC	34
SRC1186	12010	21710.1	294.892	RC	28
SRC1187	12010	21740	295.899	RC	31
SRC1188	12010	21770	296.034	RC	34
SRC1189	12039.9	21530	288.168	RC	30

BHID	Easting	Northing	RL	Hole Type	Depth
SRC1190	12040	21590	290.398	RC	40
SRC1191	12040	21650	293.094	RC	38
SRC1192	12040.1	21709.9	295.875	RC	37
SRC1193	12038.6	21769.6	297.5	RC	43
SRC1194	13779.92	19919.79	287.595	RC	50
SRC1195	13779.95	19929.79	287.742	RC	50
SRC1196	13780.01	19949.81	286.748	RC	50
SRC1197	13780.04	19959.95	286.197	RC	50
SRC1198	13719.71	20040.09	286.078	RC	50
SRC1199	13719.97	20049.99	285.912	RC	50
SRC1201	13720.22	20080.15	283.275	RC	50
SRC1202	13660.15	20099.96	285.479	RC	50
SRC1203	13660.04	20109.94	285.167	RC	50
SRC1204	13660.13	20129.99	284.923	RC	50
SRC1205	13660.05	20140.09	284.683	RC	50
SRC1206	13600.09	20099.97	285.511	RC	50
SRC1207	13600.01	20110.04	285.45	RC	50
SRC1208	13599.93	20130.13	285.375	RC	50
SRC1209	13600.06	20139.92	284.753	RC	50
SRC1210	13480.1	20100.11	286.078	RC	50
SRC1211	13480.18	20110.05	285.037	RC	50
SRC1212	13480.08	20129.93	283.475	RC	50
SRC1213	13479.8	20140.1	283.255	RC	50
SRC1214	13359.9	20399.38	283.889	RC	50
SRC1215	13360.07	20409.76	283.909	RC	50
SRC1216	13360	20430.01	283.835	RC	50
SRC1217	13360.1	20440.05	283.779	RC	50
SRC1218	13300.02	20400.26	284.177	RC	50
SRC1219	13300.08	20409.82	284.172	RC	50
SRC1220	13300.03	20429.72	284.167	RC	50
SRC1221	13299.94	20440.32	284.165	RC	50
SRC1222	13240.28	20399.56	284.353	RC	50
SRC1223	13240	20410.01	284.291	RC	50
SRC1224	13239.94	20429.99	284.224	RC	50
SRC1225	13240.05	20440.07	284.1	RC	50
SRC1263	10382.378	22878.804	307.368	RC	12
SRC1264	10504.236	22976.049	310.568	RC	13
SRC1265	10593.857	23050.707	308.296	RC	19
SRC1266	10697.323	23048.93	308.51	RC	31
SRC1267	10811.754	23017.275	308.723	RC	18
SRC1268	10914.408	22954.187	309.938	RC	18
SRC1269	11005.62	22888.736	311.86	RC	36
SRC1270	11339.791	22663	313.342	RC	12
SRC1271	11467.491	22464.471	308.222	RC	48
SRC1272	11555.239	22399.356	312.079	RC	49
SRC1273	11572.336	22276.875	307.167	RC	37
SRC1274	11665.176	22225.225	306.255	RC	30
SRC1275	11702.245	22305.777	308.853	RC	34
SRC1276	11629.426	22362.225	311.283	RC	24
SRC1277	10837.232	22896.871	310.884	RC	34
SRC1278	10816.804	22765.033	305.207	RC	28
SRC1279	10778.956	22810.218	306.226	RC	28
SRC1280	10708.066	22831.727	306.984	RC	30
SRC1281	10709.412	22775.79	305.38	RC	34
SRC1282	10653.558	22775.085	305.822	RC	50
SRC1283	10621.502	22687.866	303.43	RC	52
SRC1284	10587.368	22773.866	305.997	RC	46
SRC1285	10561.64	22822.05	308.53	RC	28
SRC1286	10588.822	22894.765	312.176	RC	18
SRC1287	10687.586	22897.044	310.516	RC	28
SRC1288	10699.097	22952.617	313.232	RC	20
SRC1289	10624.845	22939.551	312.823	RC	16
SRC1290	10929.924	22899.57	311.895	RC	22
SRC1291	10506.216	22909.484	313.744	RC	22

Clean TeQ Holdings Limited  
 ABN 34 127 457 916

Ferntree Business Park  
 12/21 Howleys Rd, Notting Hill VIC Australia 3168  
 PO Box 227, Mulgrave VIC 3170 Australia  
 T: +61 3 9797 6700 F: +61 3 9706 8344  
 W: [www.cleanteq.com](http://www.cleanteq.com) E: [Info@cleanteq.com](mailto:Info@cleanteq.com)

BHID	Easting	Northing	RL	Hole Type	Depth
SRC1292	10666.392	23006.147	310.229	RC	10
SRC1293	11072.746	22880.057	312.587	RC	18
SRC1294	11065.863	22786.65	312.599	RC	40
SRC1295	11142.38	22810.493	315.71	RC	34
SRC1296	11282.947	22495.246	309.66	RC	34
SRC1297	11185.326	22498.334	307.046	RC	16
SRC1298	10968.154	22717.819	309.25	RC	40
SRC1299	11019.844	22617.769	306.944	RC	28
SRC1300	11527.313	22535.534	308.142	RC	24
SRC1301	11604.053	22470.141	308.221	RC	38
SRC1302	11703.115	22381.364	310.324	RC	24
SRC1303	11781.393	22321.793	306.652	RC	16
SRC1304	11754.176	22271.971	305.933	RC	34
SRC1305	11671.294	22334.524	310.243	RC	28
SRC1306	11612.354	22323.928	309.739	RC	22
SRC1307	11647.834	22294.411	308.936	RC	16
SRC1308	11700.874	22258.763	307.073	RC	28
SRC1309	11441.747	22384.955	306.47	RC	10
SRC1310	10772.768	22883.149	309.68	RC	28
SRC1311	10879.637	22987.765	309.19	RC	17
SRC1312	10819.743	22949.231	310.52	RC	12
SRC1313	10858.487	22840.075	309.53	RC	29
SRC1314	10635.444	22838.793	308.14	RC	35
SRC1315	10491.521	22829.718	311	RC	31
SRC1316	10431.214	22764.907	310.23	RC	19
SRC1317	10548.733	22710.098	304.49	RC	49
SRC1318	10732.07	22644.776	302.24	RC	40
SRC1319	11267.246	22716.03	315.97	RC	19
SRC1320	11382.442	22627.365	310.9	RC	5
SRC1321	11318.085	22584.087	314.29	RC	22
SRC1322	11279.186	22626.373	313.98	RC	18
SRC1323	11207.993	22559.977	308.75	RC	5
SRC1324	11175.901	22646.216	310.35	RC	7
SRC1325	11064.652	22703.72	309.55	RC	48
SRC1326	11085.738	22643.662	308.77	RC	28
SRC1327	10985.027	22839.765	314.45	RC	28
SRC1328	10964.056	22783.332	310.68	RC	40
SRC1329	10910.402	22763.793	307.55	RC	40
SRC1330	10847.144	22704.379	304.41	RC	40
SRC1331	11417.265	22453.496	307.11	RC	10
SRC1332	11372.61	22421.233	306.11	RC	6
SRC1333	11334.271	22460.673	307.67	RC	12
SRC1334	11297.834	22407.662	306.28	RC	22
SRC1335	11224.912	22443.389	308.05	RC	16
SRC1336	11130.433	22438.392	305.24	RC	4
SRC1337	11199.667	22377.577	306.22	RC	16
SRC1338	11327.586	22283.453	302.71	RC	22
SRC1339	11264.885	22285.398	303.12	RC	13
SRC1340	11265.825	22342.843	304.13	RC	6
SRC1341	11206.788	22287.327	302.93	RC	15
SRC1342	11146.015	22343.769	305.36	RC	15
SRC1343	10731.362	22597.532	301.34	RC	31
SRC1344	11389.908	22556.061	310.18	RC	23
SRC1345	11197.868	22765.916	315.57	RC	41
SRC1346	11149.11	22735.969	312.48	RC	13
SRC1347	11027.64	22107.792	296.19	RC	39
SRC1348	11034.81	22191.159	298.29	RC	25
SRC1349	11088.024	22284.225	302.13	RC	15
SRC1350	10428.446	22573.533	299.77	RC	42
SRC1351	10482.552	22665.279	303.01	RC	48
SRC1352	10534.539	22597.147	300.7	RC	51
SRC1353	10611.686	22591.778	300.93	RC	55
SRC1354	11447.39	22282.435	304.7	RC	24
SRC1355	11399.863	22354.828	304.98	RC	12

BHID	Easting	Northing	RL	Hole Type	Depth
SRC1356	11537.341	22445.179	310.75	RC	54
SRC1357	11505.795	22396.282	309.97	RC	14
SRC1358	11506.471	22341.817	310.1	RC	12
SRC1359	11624.612	22402.11	310.83	RC	20
SRC1360	11654.422	22455.507	307.63	RC	36
SRC1361	11738.888	22395.155	308.45	RC	13
SRC1362	11730.139	22345.223	308.91	RC	19
SRC1363	11748.932	22223.046	304.85	RC	35
SRC1364	11751.8	22170.92	303.7	RC	36
SRC1365	11810.451	22281.472	304.6	RC	24
SRC1366	11866.224	22169.14	300.45	RC	20
SRC1367	11886.179	22097.425	299.81	RC	19
SRC1368	11833.165	22051.771	298.36	RC	26

**Clean TeQ Holdings Limited**  
 ABN 34 127 457 916

Ferntree Business Park  
 12/21 Howleys Rd, Notting Hill VIC Australia 3168  
 PO Box 227, Mulgrave VIC 3170 Australia  
 T: +61 3 9797 6700 F: +61 3 9706 8344  
 W: [www.cleanteq.com](http://www.cleanteq.com) E: [Info@cleanteq.com](mailto:Info@cleanteq.com)